

1977-80 CA

# OWNER'S MANUAL

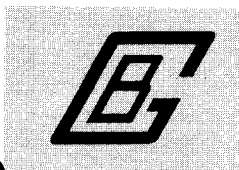

CRUISE-AIR MOTOR HOMES BY . . .

**GEORGIE BOY MANUFACTURING, INC.**

POST OFFICE DRAWER H • EDWARDSBURG, MICHIGAN 49112 • PHONE (616) 663-3835

Welcome to the recreational-vehicle lifestyle! This manual describes the many features of your recreational vehicle and gives a few simple steps relating to use or maintenance. Use these suggestions to help assure your family of years of carefree, pleasant traveling, or vacationing.

Your dealer's Service or Sales Department will promptly handle any normal problem which might occur. Customer service is of utmost importance to your dealer and is just as important to the manufacturer.

If, for some unusual reason, a problem is not handled to your satisfaction, we make the following suggestions:

1. Discuss any warranty-related problems directly with the General Manager or the Owner of the dealership, giving him an opportunity to help his service department resolve the matter for you.
2. Should a problem arise that cannot be resolved to your satisfaction by your local dealer, contact the factory representative or Georgie Boy Mfg. Inc.
3. The above steps are suggested because of our sincere belief that your dealer and the factory representative will satisfactorily handle any problem which might arise. Should you find their combined efforts have not done so, please send a letter describing the circumstances to Cruise Air, Division of Georgie Boy Mfg. Inc., P.O. Drawer H, Edwardsburg, Michigan 49112. Please include the model and serial number of your vehicle.

Thank you for choosing our product. Your Dealer and we, the Manufacturer, will continually strive to merit your confidence.

## FOREWORD

This manual describes the various design features and operating procedures of your motor home to aid you in understanding its capabilities.

Like all fine equipment, your motor home will require care and regular maintenance in order to retain its maximum performance characteristics. This manual, along with the Chassis Operator's Manual and the information from other component manufacturers provided for your use, defines the important areas of maintenance you will want to follow. The few minutes spent reading and understanding these instructions will result in your having a good working knowledge of the unit. Knowing how to use your motor home and how to keep it properly maintained will help you enjoy thousands of miles of motoring pleasure.

Your motor home has been designed to conform with or exceed the American National Standards Institute Code A119.1 and/or State and Federal motor vehicle standards as applicable. These Standards establish the plumbing, heating, electrical, and other requirements for quality and safety. Compliance with this Standard is indicated by the seal installed just outside the entry door. This seal is the outward sign of internal quality.

Should you have any questions regarding operation, maintenance or service, please contact your DEALER immediately so he can be of assistance.

# TABLE OF CONTENTS

PLANNING AND PREPARATION .....	1
VEHICLE LOAD CAPACITY – WEIGHING .....	6
READY TO LEAVE	
Starting and Warmup .....	6
Safety Belts .....	6
ON THE ROAD	
Driving and Parking .....	7
Overheating .....	7
Windshield Defrost-Comfort Control .....	7
12V Fuse Replacement .....	7
Changing a Tire .....	7
SERVICING	
Motor Home Chassis Operator's Manual .....	8
Engine and Service .....	8
Battery Service .....	8
Auxiliary Battery Service .....	8
Generator Power Plant System Service .....	8
PLUMBING	
Fresh Water .....	9
External Water Supply .....	9
Filling Fresh Water Supply .....	9
Troubleshooting Water System .....	10
Sanitizing Water Tank .....	10
Waste Water System .....	11
Waste Water Draining .....	11
Winterizing Water System .....	12
Do's and Don'ts .....	12
ELECTRICAL	
115-Volt System .....	13
12-Volt System .....	13
12-Volt Fuses .....	13
Auxiliary 12-Volt Battery .....	16
Auxiliary Generator Power Plant .....	16
Roof Air Conditioner .....	16
Standard Automotive Air Conditioner .....	17
115-Volt AC to 12-Volt DC Converter .....	17
LIQUID PETROLEUM GAS (LPG) SYSTEM	
Using your LPG System at Low Temperatures .....	18
Filling the Chassis-Mounted LPG Tank .....	18
LPG System Leak Checks .....	19
LPG APPLIANCES	
Range Top and Oven .....	19
Forced Air Furnace .....	19
Water Heater .....	20
LPG/Electric Refrigerator .....	20
EQUIPMENT AND FURNISHINGS	
Pedestal Seats .....	20
Spring-Balanced Bunk Beds .....	20
Pedestal Dinette Tables .....	20
Pull-Out (Gaucho) Beds .....	21
Dinette Bed .....	21
Storage .....	21
CARE AND MAINTENANCE	
Interior Cleaning .....	21
Draperies, Cushions and Upholstery Fabrics .....	21
Wall Paneling .....	21
Carpeting .....	21
Fixtures .....	21
Windows .....	21
Locksets and Latches .....	22
Plumbing .....	22
Condensation and Ventilation .....	22
Exterior Care .....	22
Exterior Metal and Trim .....	22
Roof .....	22
Repairs .....	22
WARRANTY .....	Inside Back Cover

# PLANNING AND PREPARATION

Plan your trip and organize all preparations before you leave. Proper preparation can be the key to getting the most enjoyment from your motor home (see Figure 1). The following suggestions are provided only as a guide. Review them carefully before starting on your first trip. Refer to the list when on trips and make note of items forgotten to make subsequent trips even more enjoyable.

- Plan your route carefully. Consult maps and guidebooks (available at most bookstands and newstands) to become aware beforehand of any road conditions, campsite availability, and other circumstances.
- **BE SURE ALL EQUIPMENT IS SERVICED AND READY FOR TRAVEL.** Check the following items.
  - a. Check all fluids including:
    - Motor home engine crankcase oil
    - Transmission fluid
    - Power steering fluid
    - Radiator recovery system reservoir level
    - Master cylinder brake fluid
    - Electrolyte level of batteries
    - Windshield washer reservoir level
  - b. Inspect wheel lugs for tightness. Examine all tires for road damage, then inflate to the proper pressures as recommended in the Chassis Operator's Manual. In using your Chassis Operator's Manual, note that tire pressures are given for cold tires which are to be used under normal driving and load conditions, and also for unusual operating or load conditions.
  - c. Check oil level in the generator power plant (if installed). Refer to instructions and maintenance manual provided by the generator manufacturer for other pre-use service requirements applicable to this equipment. Check that extra oil and other service supplies are provided for the generator power plant if the motor home is to be used for extended periods.
  - d. Check that jack, jack handle, and lug wrench are properly stowed.
  - e. Check that the 115-volt power cord is properly stowed in compartment. A power supply cord adapter will be required in some camping areas. Be sure to use adapters which provide proper electrical ground.
  - f. Check that a serviceable fire extinguisher is secured in the mounting bracket.
  - g. Verify that all items you plan to take are on board.

**NOTE:** Be sure the weight of passengers, equipment, and supplies does not

cause your motor home to exceed axle loads and overall vehicle loads for which it was designed. If in doubt, weigh the vehicle at a public scale. See paragraph on "Weighing."

- h. Check that accessories, such as a plastic sewer hose with the necessary fittings and a water supply line (such as garden-hose type approved for 125 psi) are on board. (It may be desirable to check ahead with specific campsites where you plan to stop for any special adapters which may be required.)
  - j. Fill fresh water tank, if required. (Refer to Plumbing Section.)
- Check to see that drain-line cap and holding-tank knife valve(s) are closed and secured. Add a holding-tank chemical to a few gallons of water in your body-waste holding tank. (Refer to Plumbing Section.)
  - Check all stop lights, running lights, and other vehicle safety items.
  - Put motor home contents in "travel" condition.
    - a. Secure any loose objects which could shift while traveling.
    - b. Secure refrigerator contents (place lids on all containers holding liquids, for example) then secure locking latch on refrigerator door.
    - c. Be sure all cabinets have the contents secured and the doors latched.
    - d. Be sure all exterior doors are closed and locked.
  - Adjust the driver's seat to the most comfortable position, then adjust the side-view mirrors for maximum visibility.
  - Fill the fuel tank(s) and give special attention to the operation of the fuel tank switch-over valve (when the optional auxiliary fuel tank is installed) (see Figure 2). Your motor home is designed to use only the fuel recommended in the Chassis Operator's Manual. It is recommended that you use fuel from the auxiliary tank first. Never run a fuel tank completely dry when driving since it can cause the engine to stall and may result in a delay in restarting the engine when switching to the main fuel tank.

## WARNING

**ALWAYS EXTINGUISH PILOT LIGHTS AND OPEN FLAMES ON APPLIANCES BEFORE FILLING YOUR GASOLINE TANK(S) AND LP TANK.**

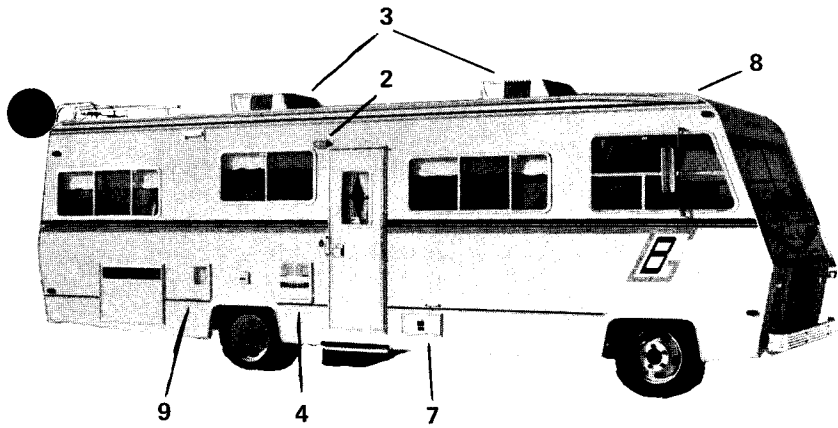

- 1 Running Lights
- 2 Service Lights
- 3 Roof Air Conditioner (Optional)
- 4 Furnace Vent
- 5 Main Fuel Tank
- 6 Auxiliary Fuel Tank
- 7 Chassis-Mounted LPG Tank

- 8 Roof Vents
- 9 Water Heater Service
- 10 Waste Water Connection - Knife Valve (below)
- 11 Refrigerator Service
- 12 Drain Hose Storage Tube
- 13 25 ft. 115-volt AC Power Cord Storage Compartment
- 14 Fresh Water Tank Fill
- 15 Fresh Water Tank Drain
- 16 City Water Connection

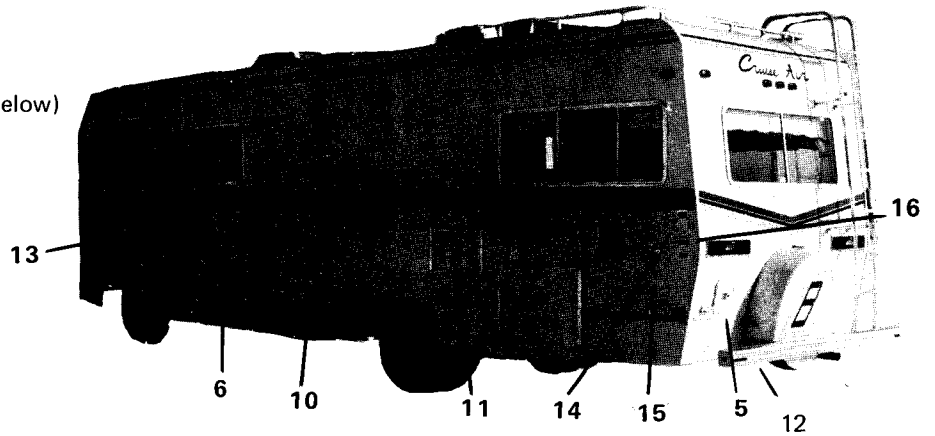

- 17 Running Lights
- 18 Front Engine Service Door
- 19 Parking, Turn Signal and Emergency Flasher Lights
- 20 Headlights
- 21 Engine Service Panels

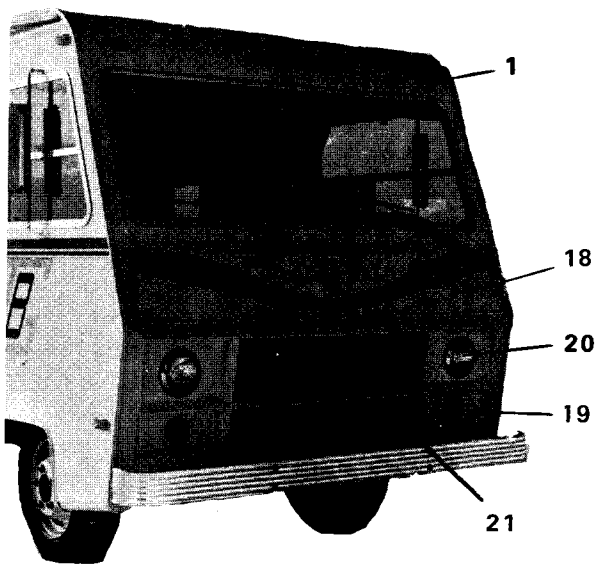

- 22 Tail, Stop, Turn and Emergency Flasher Lights
- 23 Back-up Lights

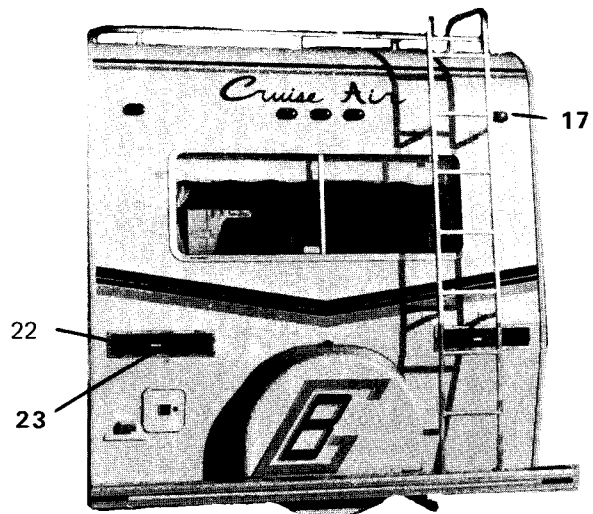
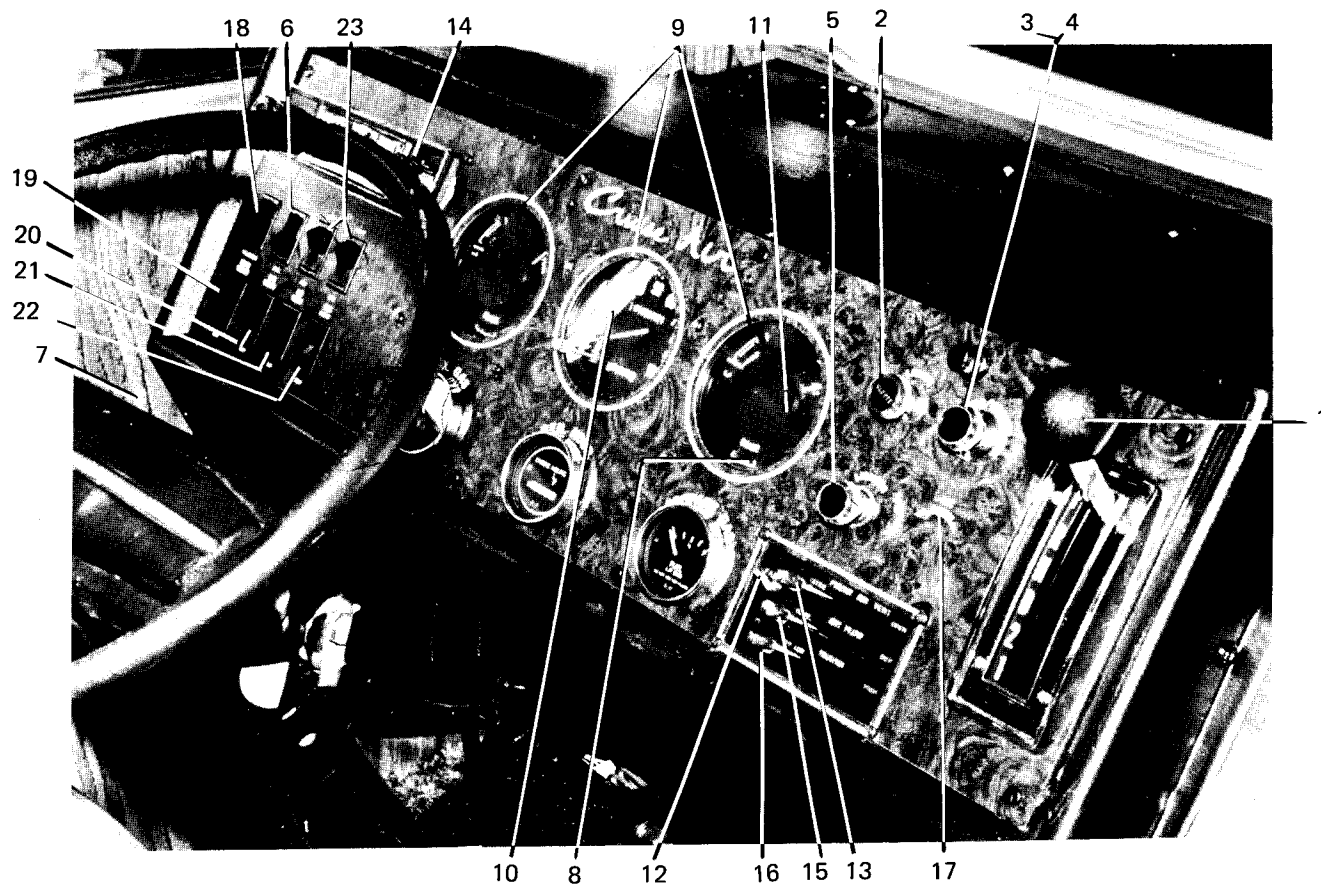

FIGURE 1 – TYPICAL MOTOR HOME LAYOUT



- |   |   |                        |
|---|---|------------------------|
| 1. Shift Selector                       | 9. Instruments (See your Chassis Operator's Manual) | 18. Marker ICC Flasher |
| 2. Lights                               | 10. Hi-Beam Indicator                               | 19. Dome Lights        |
| 3. Windshield Wipers                    | 11. Turn-Signal Indicator                           | 20. Fog Lights         |
| 4. Windshield Washers                   | 12. Heater Blower                                   | 21. Air Horn           |
| 5. Lighter                              | 13. Fresh Air                                       | 22. Generator          |
| 6. Fuel Switchover                      | 14. Radio Sound System                              | 23. Fan (Left Right)   |
| 7. Turn Signal Lever and Cruise Control | 15. Defrost   |                        |
| 8. Brake Indicator                      | 16. Temperature Control                             |                        |
|   | 17. A/C   |                        |

**FIGURE 2 — TYPICAL INSTRUMENT PANEL AND CONTROLS — CLASS "A"**

- Fill the liquidpetroleum gas (LPG) fuel tank(s) if required.
- Check for spare fuses of every size used in the vehicle.

Take the time before leaving to become familiar with the location and operation of the instrument control panel and other items in the driver compartment. Check all instruments to verify that equipment is working. Dash instrument controls (see Figure 2) include: two-speed wiper control, windshield washer, lighter, fuel switch-over valve (optional), three-speed heater/defroster blower control, heat level control, fresh air control, defroster control, and the under-dash air conditioner blower/temperature controls (optional). Also located on the dash is the sound

system. The cruise control (optional) is located on the turn indicator handle. The emergency flasher control is located on the right side of the steering column. Refer to the Chassis Operator's Manual or individual instructions from equipment manufacturers for operation of equipment, both standard and optional.

It is recommended that the Chassis Operator's Manual (provided in your Owner's Information Kit) be kept readily available in the glove compartment. This will prove invaluable as reference information.

— DRIVE SAFELY —

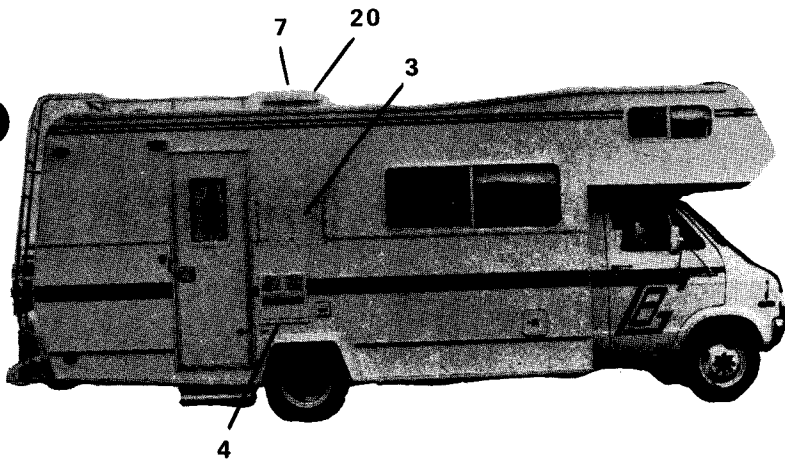

- 1 Running Lights
- 2 Battery Box (Optional)
- 3 Refrigerator Service
- 4 Furnace Vent
- 5 Main Fuel Tank
- 6 Chassis-Mounted LPG Tank

- 7 Roof Vents
- 8 Water Heater Service
- 9 Waste Water Connection - Knife Valve (below)
- 10 Drain Hose Storage Tube
- 11 25 ft. 115-volt AC Power Cord Storage Compartment
- 12 Fresh Water Tank Fill
- 13 City Water Connection

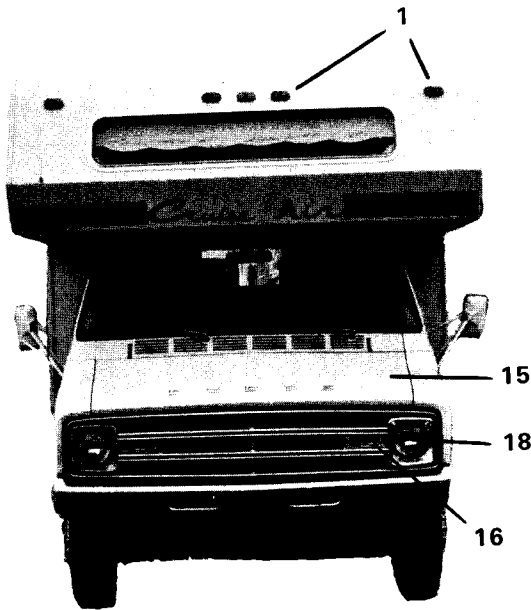
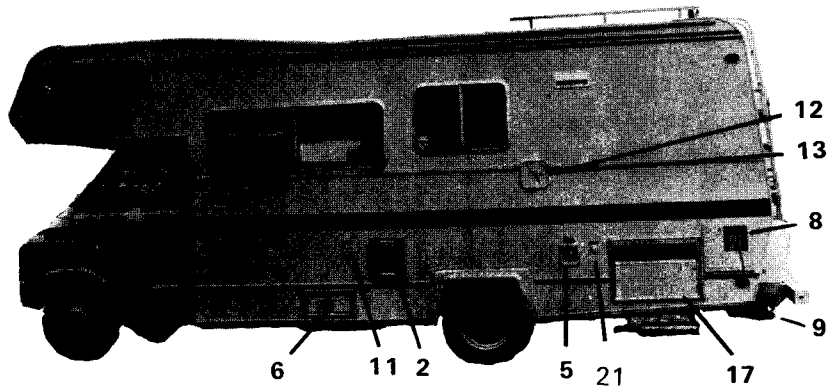

- 14 Running Lights
- 15 Front Engine Service Door
- 16 Parking, Turn Signal and Emergency Flasher Lights
- 17 Storage Compartment

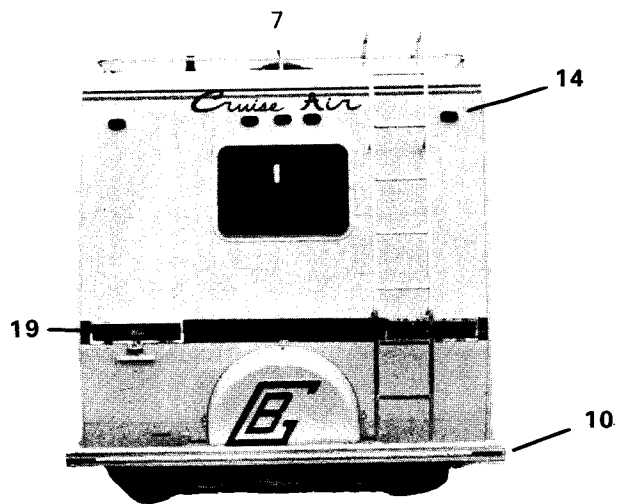

- 18 Headlights
- 19 Tail, Stop, Turn, Back-Up and Emergency Flasher Lights
- 20 Roof Air Conditioner
- 21 Fresh Water Tank Drain

FIGURE 1 – TYPICAL MINI HOME LAYOUT

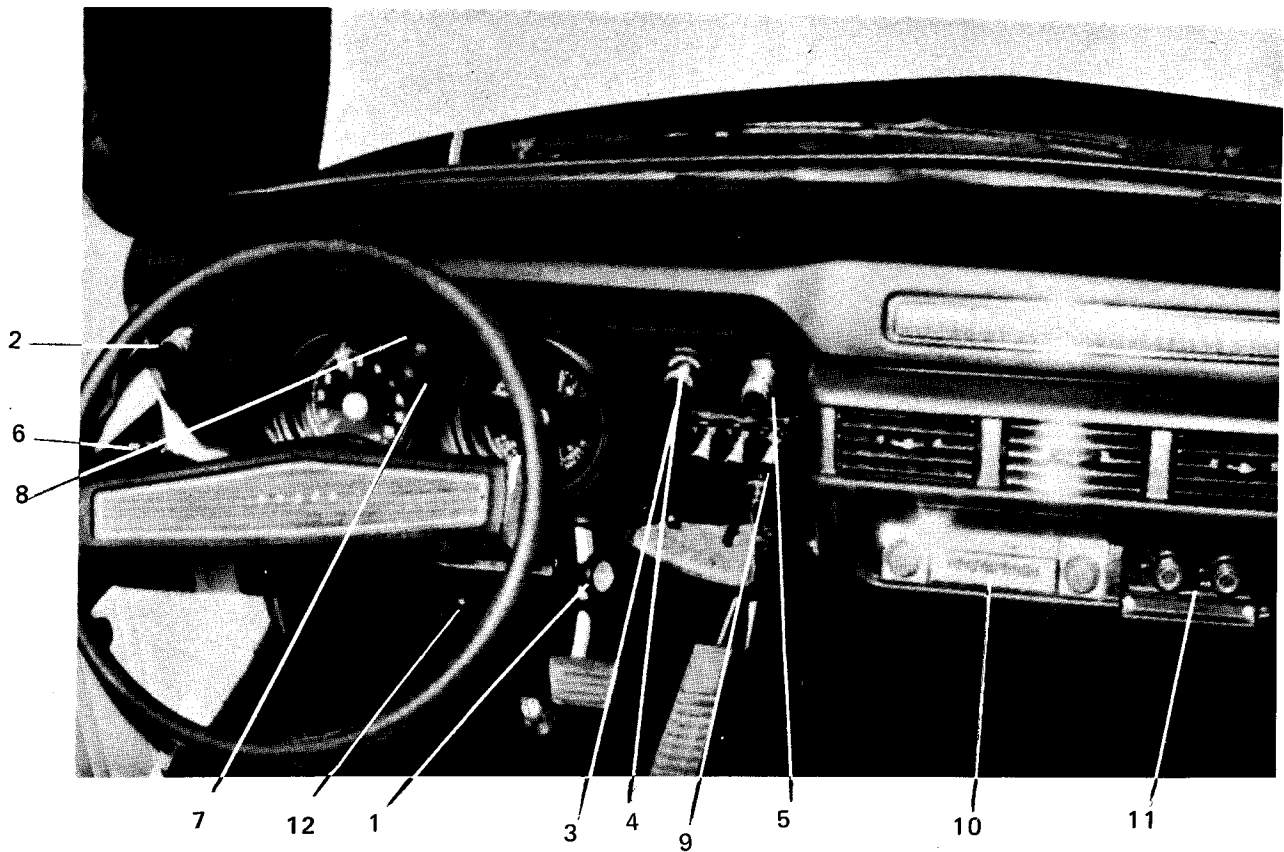

- |  |  |
|--|--|
| 1. Shift Selector                          | 7. Instruments (See Your Chassis<br>Operator's Manual) |
| 2. Lights                                  | 8. Turn-Signal Indicator                               |
| 3. Windshield Wipers                       | 9. Heater Blower                                       |
| 4. Windshield Washers                      | 10. Radio Sound System                                 |
| 5. Lighter                                 | 11. A/C  |
| 6. Turn Signal Lever and<br>Cruise Control | 12. 12-Volt Chassis Fuse Panel                         |

FIGURE 2 — TYPICAL INSTRUMENT PANEL AND CONTROLS — MINI HOME



# VEHICLE LOAD CAPACITY – WEIGHING

Your motor home is designed to carry the loads defined by the Gross Axle Weight Rating (GAWR) and Gross Vehicle Weight Rating (GVWR) shown on the certification tag posted on or near the left edge of the instrument panel. These ratings are for a fully-loaded vehicle including passengers and normal belongings.

**NOTE:** Exceeding the GAWR or GVWR of your motor home can cause undesirable handling characteristics and may even create a safety hazard. Modification of your vehicle by addition of racks not specified by the manufacturer to carry additional equipment or vehicles is not recommended and may make your warranty inapplicable.

Periodically weigh the motor home at a public scale to determine axle loads. The following procedure is suggested, although any method recommended by the scale operator which correctly determine weight values is acceptable. During all measurements, it is important that the vehicle be kept as level as possible.

1. Run only the front wheels onto the scale platform and obtain a reading. (This first value is the front axle Gross Axle Weight.)

2. Next, place the entire vehicle (both axles) on the scale and obtain a reading. (This second value is Gross Vehicle Weight.)
3. Drive forward until only the rear axle is on the platform and obtain a reading. (This third reading is rear axle Gross Axle Weight.)
4. Compare reading 2 with the GVWR of your vehicle. If this reading exceeds the GVWR rating, it will be necessary to reduce total vehicle load.
5. If reading 2 is less than the GVWR of your vehicle, check readings 1 and 3 to verify that each is less than the GAWR on the certification tag. If either exceeds the GAWR for the axle, redistribute enough equipment from front to back or the reverse to ensure that loads on front and rear axles are within the required limit.

Check vehicle weight periodically to obtain optimum mileage from tires and improved handling. Tires should always be inflated as recommended in the Chassis Manufacturer's Instructions. See your Chassis Operator's Manual.

## READY TO LEAVE

The following suggestions may be helpful when you are ready to leave. (BE SURE TO PLACE THE ENTRY STEP IN TRAVEL POSITION.)

### STARTING AND WARMUP

For best results, always follow the recommendations in your Chassis Operator's Manual when starting or operating your engine.

**NOTE:** Be sure transmission is in neutral and parking brake is engaged to keep the motor home from rolling. If the parking brake needs adjustment, see the Chassis Operator's Manual for proper adjustment instructions.

### SAFETY BELTS

Seat belts are an important safety feature of your vehicle. For your protection, it is required that all belts be fastened while your motor home is in motion. The driver's seat and all other seats designed to carry passengers, while under way, have been equipped with safety belts.

**NOTE:** Seats which are not equipped with safety belts should not be occupied while vehicle is in motion and will be labeled: "NOT FOR USE WHILE VEHICLE IS IN MOTION."

Safety belts are adjusted in the following manner: To lengthen the belt, tip the buckle at right angles to the

belt, as shown in Figure 3. Holding the buckle in this position permits the belt to slide through. Pull on the buckle until the desired length is obtained. To fasten the belts, make sure the belts are not twisted, then push the tongue end of one belt into the buckle of the mating belt. Be sure it goes in all the way and that it latches. Tighten by pulling the loose end of the belt while holding the buckle. Adjust the belt as low on the abdomen and as snug as comfort will allow for greatest safety. Never use a belt for more than one person at a time.

**NOTE:** If your belts have been equipped with retractors, be sure belt is pulled all the way out of retractor.

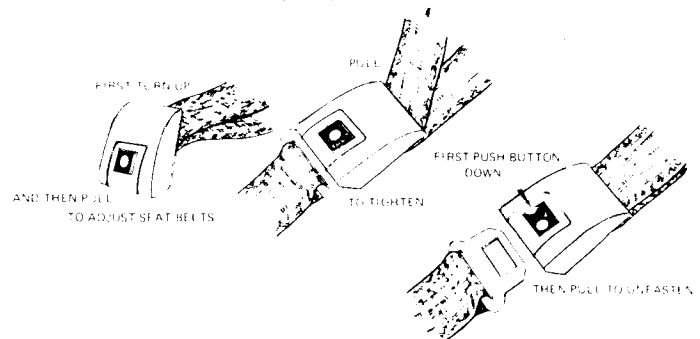

FIGURE 3 – SAFETY BELT ADJUSTMENT

# ON THE ROAD

## DRIVING AND PARKING

Driving the motor home is comparable to driving your family car, once you become accustomed to the feel of the controls and to the reference points from the driver's seat relating to the position of the motor home in traffic. Be cautious when maneuvering to allow for the length and width of the vehicle. Always allow extra room in cornering and when changing lanes. Check the side mirrors often. Learn to use the view of the roadway behind, as seen through the side mirrors, as a reference to help keep a good road/lane position.

Drive with consideration on the highway, observing all applicable speed and safety regulations. The best cruising speed for your motor home will vary with road and weather conditions. Remember that the higher speeds may result in a sharp increase in fuel consumption.

Driving on winding or mountain roads is not difficult if done with reasonable care. Observe proper vehicle speeds when ascending or descending hills and always operate in the proper transmission range. Downshift on hills to avoid overheating or undue engine loads by using the hand control as recommended by the Chassis Operator's Manual.

Allow for the extra height of your coach and avoid areas having low overhead clearance. Check for low-hanging tree branches or other obstructions whenever you drive or park. Avoid low roofs when pulling in for service. This may be particularly important if you drive with the overhead vents open or if the coach is equipped with a roof air conditioner or a roof rack.

When parking parallel, be sure to allow for poles or obstructions near the curb, as front and rear portions of the motor home swing wider than an automobile. When parking on an incline, it is recommended that the front wheels always be turned into the curb in the direction of roll to aid the parking brake.

## OVERHEATING

The engine and cooling system on your vehicle should be operated and serviced as recommended in your Chassis Operator's Manual.

## WINDSHIELD DEFROST — COMFORT CONTROL

During winter months, it is important to keep the windshield clear and keep the passenger compartment at comfortable temperatures while on the road. This can be done by use of the proper combination of heater and defroster controls.

## 12-VOLT FUSE REPLACEMENT

If part of your vehicle electrical system should fail while on the road, check the replacement circuit fuses located in the automotive circuit. These are automotive-type fuses available at most service stations. Refer to the ELECTRICAL section for information on living area (non-automotive) 12-volt fuses.

## CHANGING A TIRE

For tire changing instructions, see Chassis Operator's Manual. Your motor home is equipped with premium-grade truck-type tires. Under normal circumstances and with proper tire maintenance, you should receive thousands of miles of trouble-free service. Before attempting any repairs in the event you do have a flat tire, it should be noted that your fully-loaded motor home is very heavy. As a result, each wheel lug nut is torqued to a factory recommended setting of 480 to 500 foot pounds, making the lug nuts extremely difficult to remove. In addition, each tire and wheel weighs approximately 90 pounds and is difficult to handle. It is therefore advisable that you obtain road service wherever possible and only attempt to change tires yourself under emergency conditions.

## WARNING

**LOOSENING THE REAR LUG BOLTS MAY RELEASE BOTH OUTSIDE AND INSIDE WHEELS. DO NOT ATTEMPT TO REMOVE LUGS WITHOUT HAVING A JACK IN PROPER POSITION TO ABSORB WEIGHT.**

If the flat tire is on one of the inside (rear) dual wheels, the outside wheel on that side will give adequate support and no tire change may be required. Just continue at reduced speeds to a service station for repair.

## CAUTION:

**DO NOT EXCEED 25 MPH NOR DRIVE FOR LONG DISTANCES AS THIS MAY OVERHEAT THE SINGLE REAR TIRE CAUSING A BLOWOUT.**

# SERVICING

## MOTOR HOME CHASSIS OPERATOR'S MANUAL

Refer to your Chassis Operator's Manual for information on chassis service recommendations. As a general practice, you should have the coolant, the battery electrolyte, and the engine oil levels checked each time when refueling.

**NOTE:** Proper engine servicing and record of servicing may be mandatory to ensure chassis warranty protection. Follow the manufacturer's instructions on periodic maintenance checks.

### ENGINE SERVICE

Items serviced from the exterior of the coach are reached through the front access door. This door permits servicing the vehicle batteries, the radiator and coolant system, the engine oil level and oil filler cap and windshield washer. Refer to Figure 4 for location of these items and for door latch information.

By removing the front bumper, front center grille piece, and optional equipment (such as air conditioner and transmission cooling coils), access will be provided to the radiator and the engine removal. Items serviced from inside the coach are reached through the engine compartment cover located between the driver and passenger seats. This gives access to the power steering reservoir, transmission oil dipstick and the air cleaner. When the engine is being serviced from inside the

coach, protect your carpet and furnishings against oil and dirt. Your serviceman will be glad to use a protective cloth if you remind him.

### CLASS "A" MOTOR HOME

Fill brake cylinder reservoir from outside on left front wheel area under floor.

### BATTERY SERVICE

#### Main Vehicle Battery

Your motor home has a 12-volt automotive battery located under the front engine access door. Have this battery serviced when fueling or servicing other vehicle systems.

#### Auxiliary Battery Service

There is an auxiliary 12-volt battery to provide living area power requirements. Service this battery when fueling or servicing other vehicle systems.

### GENERATOR POWER PLANT SYSTEM SERVICE

Generator power plant service, recommended by the Generator Manufacturer, should be performed at an authorized service center (listed in the material provided in your Owner's Information Kit). Routine or emergency service, such as adding oil, changing filters or replacing spark plugs, could be accomplished at auto service centers, but must be done in accordance with the service instructions specified by the Generator Manufacturer.

1. Engine Service Door
2. Windshield Reservoir
3. Radiator and Coolant Fill
4. Main Vehicle Battery
5. Engine-Oil Dipstick
6. Auxiliary Battery
7. Windshield-Wiper Motor
8. Engine-Oil Filler Cap
9. Power-Steering Reservoir
10. Air Cleaner
11. Transmission Dipstick & Filler Cap
12. Brake Cylinder Reservoir Area under floor.

### INSIDE ENGINE COVER REMOVED

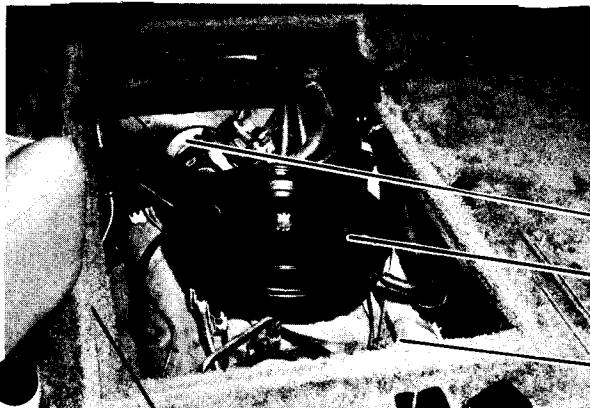

12

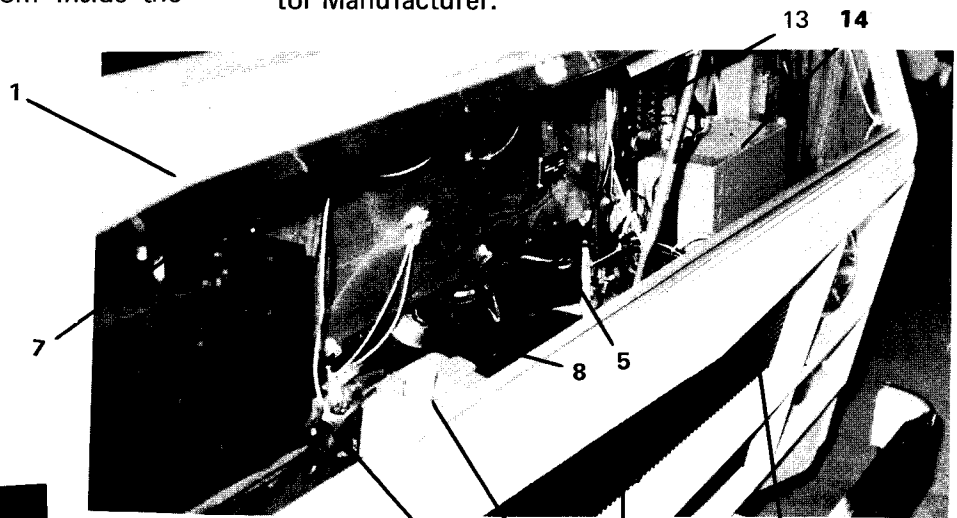

13. Automotive Fuse Panel
14. TRIAD Converter

FIGURE 4 - TYPICAL ENGINE SERVICE AREAS

# PLUMBING

## FRESH WATER

Fresh water is provided from one of two sources:

1. City water, provided under pressure when the motor home is hooked up to a park or city water supply;
2. Water stored in an on-board water tank with pressure provided by a pump operating automatically from your 12-volt electrical system.

## EXTERNAL WATER SUPPLY (See Figure 6)

When camped in a park or near a city water supply, connect the water supply to the motor home as follows:

1. Turn water pump switch inside the motor home to OFF.
2. Remove protective cap over city water inlet pipe on your motor home.
3. Connect water hose to the motor home inlet and to the city water supply line.
4. Turn city water supply valve to ON.
5. Let the water run a few minutes with your supply line attached to clean the lines.

### CAUTION

BOTH THE ON-BOARD PUMP AND ON-BOARD FRESH WATER TANK ARE NOW ISOLATED FROM THE WATER PRESSURE IN THE SYSTEM. DO NOT TURN PUMP ON UNTIL PRESSURE LINE IS DISCONNECTED TO AVOID DAMAGING THE PUMP.

Use the following procedure to disconnect the city water supply:

1. Turn the city water supply valve to the CLOSED position.
2. Disconnect the water supply hose from the motor home inlet connection and replace inlet pipe protection cap. If the on-board tank is to be filled, go to next step. If not, store the supply hose in available compartment.

### CAUTION

UNLESS YOU HAVE A PRESSURE REGULATOR IN THE SYSTEM, IT MAY BE NECESSARY TO TURN WATER SUPPLY DOWN (OR OFF) AT NIGHT TO AVOID DAMAGE TO WATER SYSTEMS IN SOME CAMPGROUNDS HAVING UNUSUALLY HIGH WATER PRESSURE AT NIGHT.

3. Fill on-board fresh water tank (see Figure 6), from city water source if needed, then remove hose and store in available compartment.

## FILLING FRESH WATER SUPPLY

The on-board fresh water supply in your motor home provides fresh water automatically to all systems whenever a faucet is opened. Pressure is provided by a 12-volt DC automatic self-priming pump which functions any time power is available and the pump switch near the sinkbase is ON (see Figure 6).

### CAUTION

DO NOT RUN THE PUMP WITHOUT WATER IN THE SYSTEM. ALWAYS KEEP THE SWITCH OFF WHEN THE WATER SYSTEM IS EMPTY OF WATER OR WHEN CONNECTED TO CITY WATER. RUNNING THE PUMP WHEN DRY CAN DAMAGE IT AND MAY MAKE THE WARRANTY INAPPLICABLE.

Your on-board water storage tank is filled through a special filler cap (see Figure 6) outside the vehicle. To fill the fresh water tank, proceed as follows:

1. Turn water pump switch to OFF.
2. Open the water tank filler spout.
3. Fill the water tank.
4. Close the water tank filler spout.
5. Turn pump ON. Water pressure system is now activated. Turning on any faucet will result in water flow.
6. With pump ON, open all HOT and COLD water valves to remove trapped air and to fill the hot-water heater, then refill the fresh water tank.
7. During normal operation, the water pump will cycle on and off as the pressure varies.

It is a good practice to avoid leaving water in the tank when not in use.

### WARNING

USE ONLY POTABLE (DRINKING QUALITY) WATER IN THE TANK. TO ENSURE CLEAR, FRESH WATER, DRAIN TANK AFTER USING. FLUSH AND DRAIN BEFORE EACH USE AND SANITIZE IF SYSTEM SEEMS TO GIVE WATER A TASTE. SEE DIRECTIONS FOR SANITIZING THIS SYSTEM.

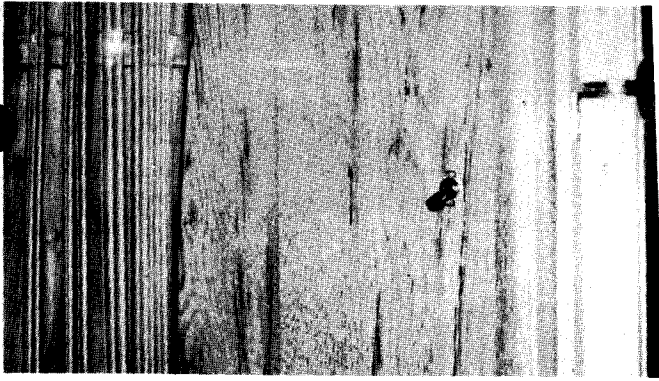

FRESH WATER SYSTEM, PUMP SWITCH

(Keep switch in OFF position when tank is empty or city water is being used.)

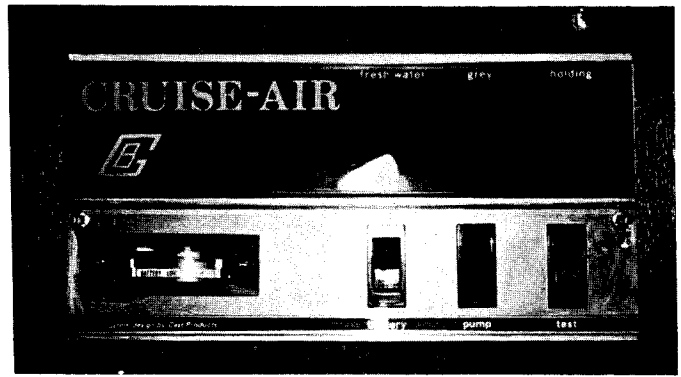

SYSTEMS CONTROL – OPTIONAL

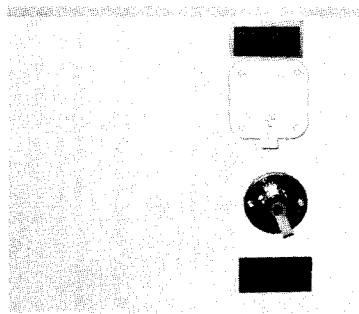

FRESH WATER FILL LOCATION

CITY WATER INLET

(Keep cap in place when city water is not being used.)

FIGURE 6 – FRESH WATER SYSTEM COMPONENT LOCATIONS

### CAUTION

WHEN IN CLIMATES WHERE FREEZING TEMPERATURES MIGHT OCCUR, BE SURE THAT ALL WATER SYSTEM COMPONENTS, INCLUDING THE STORAGE TANK ARE DRAINED OR PROTECTED BY A SPECIAL TYPE OF NONFREEZING ADDITIVE IF THE VEHICLE IS TO BE LEFT UNHEATED. (Refer to paragraph on "Winterizing the Water System.")

### TROUBLESHOOTING WATER SYSTEM

During normal use, your pump should operate automatically (if power is provided and the pump switch is ON) whenever a faucet is turned on. Should your on-board water supply fail to function when a faucet is opened, check to see that the pump switch is ON. If the switch is ON, check the fuse. If no pressure is available, although the pump switch is ON, power is available, and the pump fuse is intact, refer to the information provided by your water pump manufacturer for instructions.

If the water pump continues to operate when no water is being used, there may be a leak in the system or in a faucet. If no leak is found and the pump continues to operate, refer to the information provided by the water pump manufacturer for additional checks.

### SANITIZING WATER TANK

It is suggested that your fresh water tank be renewed periodically using a chlorine solution followed by clear water rinses.

1. Prepare a chlorine solution by adding 1/4 cup of liquid household chlorine-base bleach solution to one gallon of potable (drinking quality) water.
2. Add at the rate of one gallon of this solution to the empty supply tank for each 15 gallons of tank capacity.
3. Fill balance of tank with potable water.
4. With pump ON, open each faucet long enough for water to run out, to remove all air from system and lines.
5. Allow the system (now filled with chlorine solution) to stand for at least three hours. Before performing the following step, provisions should be made to allow for drainage of all water from the fresh water tank.
6. Flush the piping by running water through faucets for at least one minute each.
7. Turn pump OFF.
8. Drain tank and pipes by opening tank drain valve. Open each faucet to permit water to drain from each pipe.

9. When the tank is empty and each faucet has been opened, drained and closed, close the drain valve.
10. Fill system with clear fresh water.
11. Repeat steps 6 through 9.
12. Partly fill the system with fresh water and check the tank and system for taste and odor. If a chlorine taste or other traces of impurity remain, accomplish step 13. If the system is clear, go to step 14.
13. Prepare a solution of 1-quart vinegar in five gallons of water and place in tank. Fill the system completely. Agitate this solution by vehicle motion, then repeat steps 4 and 5.
14. Repeat steps 6 through 9 to empty the system.
15. If the system is to be used, fill with fresh water. If not, the system is ready for storage.

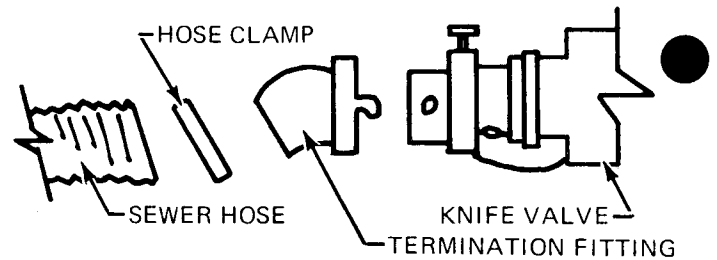

FIGURE 7 – TERMINATION FITTING INSTALLATION

## WASTE-WATER SYSTEM

Your Motor Home has a self-contained "Double Holding Tank" drainage system in which body wastes enter (1) tank and shower, lavatory, and sink enter the other tank. These tanks are to be emptied at a disposal station only. You may use either system while in transit with the drainage cap securely in place.

The holding tank should be evacuated only at intervals since the dumping action is more effective in removing solids when the tank is relatively full. **DO NOT PULL THE HOLDING TANK KNIFE VALVE OPEN WHEN THE PROTECTIVE CAP IS IN THE SECURED POSITION.** Always assure that the tank is evacuated into an acceptable sewer inlet or dump station. To evacuate wastes from the holding tank, proceed as follows:

1. Remove the plastic sewer hose from the capped storage tube (see Figure 1). The hose has been compressed for storage but will extend as needed.
2. Place sewer line over the termination fitting and secure by tightening the "C" type clamp (see Figure 7).

3. Place a container under the drain outlet to catch any water in the drain if required, then remove the protective cap from the drain outlet by turning it firmly counterclockwise (see Figure 8).
4. Place the plastic termination fitting over the motor home drain outlet and secure by turning firmly clockwise, being careful that the clips catch firmly to hold the line in place.
5. Insert the ground end of the sewer line into a ground sewer or dump station outlet, pressing it firmly far enough into the opening to be secure. In some cases, adapters may be required between the line and the inlet. Arrange sewer line between motor home outlet and dump station so that it is free from dips.
6. Unlatch body waste holding tank knife valve by removing wire clip or unscrewing lock screw. Grasp the handle firmly and slide the valve open with a quick steady pull.
7. Allow sufficient time for the tank to be completely drained. Rinse and flush tank if necessary, or if the vehicle is to be stored. When tank is empty, push handle inward to close valve. Reset retaining clip or replace cap. Repeat Steps 6 & 7 for Grey water tank.
8. Remove the sewer hose by turning termination fitting counterclockwise.
9. Rinse out sewer hose with a separate fresh water hose or supply, then remove line from ground inlet.
10. Stow sewer line and fitting and replace sewer or dump station cover if applicable.

**PLEASE . . . . . USE GOOD HOUSEKEEPING WHEN DRAINING WASTES AT A CAMPSITE OR DISPOSAL STATION. LEAVE THE SITE IN GOOD ORDER. ABOVE ALL, AVOID POLLUTION OF LAKES AND STREAMS.**

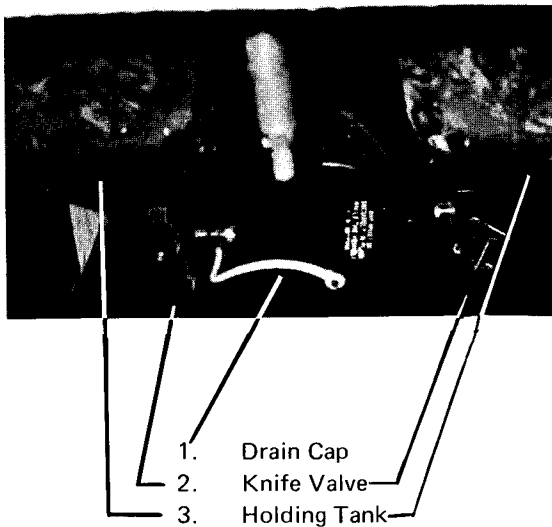

**FIGURE 8 – TYPICAL WASTE WATER SYSTEM DRAIN WITH DUAL TANKS**

### WINTERIZING THE WATER SYSTEM

If the motor home is to be stored in temperatures below freezing, the fresh water and waste systems should both be winterized as follows:

1. Drain fresh water tank by opening water tank drain spigot mounted through the wall.
2. Turn pump ON. Open a cold water faucet. When flow of water has stopped, turn pump OFF.
3. Open the drain caps on HOT and COLD water pipes. (These are located under the lavy area. On rear-bath models, the caps are located above the floor in the lavy cabinet.) After all water has been drained from the water pipes, close caps.
4. Drain water heater by opening drain plug at bottom of heater and safety valve. Also, open the hot water faucets.
5. Drain waste water system by following normal procedure for emptying holding tank (refer to paragraph on Waste Water Draining).
6. Place a minimum of 1-1/2 gallons of approved non-toxic antifreeze solution for plastic piping, drains, and traps in water tank. Open all cold water faucets, turn water pump ON, and operate

until the tank has emptied solution into the system.

7. Pour one-half cup of this solution into each drain to ensure that traps are protected.

Have automotive radiator solution tested to ensure that vehicle is well protected to any anticipated freezing level, as recommended in Chassis Operator's Manual.

The above is a basic procedure designed to be performed by the Motor Home Owner. In areas of extreme cold, extra freeze protection can be obtained by scheduling a motor home dealer to perform this winterization for you. He has specialized equipment that will enable him to blow the water and drain lines clear.

### DO'S AND DON'TS – WASTE TANKS

- DO keep your holding tank clean using any cleaner approved for recreational vehicle sanitation systems.
- DO add a special deodorizer or chemical additive approved for recreational vehicle systems to sanitize and improve the tank action.
- DO guard against freeze-up.
- DO keep your tank knife valve closed, permitting the tank to get as full as convenient before emptying.
- DO keep tank knife valve and the drain cap tightly in place when traveling to permit use of the system when on the road.
- DO use any soft (single-ply) toilet tissue.
- DO open the bath vent to keep bathroom fresh.
- DON'T put facial tissues, paper, alcohol type anti-freeze, sanitary napkins, or household toilet cleaners in your holding tank.
- DON'T put anything solid in your holding tank which can scratch or damage the plastic.

# ELECTRICAL

Your motor home has two electrical systems. One provides 115-volt power to operate all 115-volt living area recepts and appliances. This system is used when power is available from a ground power source or from an on-board generator power plant, if one is installed. The second system uses on-board batteries or a 12-volt converter to provide power for all 12-volt lighting, appliances, and accessories as well as normal vehicle needs (see Figure 11).

## 115-VOLT SYSTEM POWER CONVERTER (Outside)

A 25-foot, heavy-duty, power-supply cord is provided in a storage compartment (see Figure 10). This cord is pulled out and connected to any adequate 115-volt power source to activate all power circuits. The connector is rated for 30-amp capacity. Use this power plug only with the proper mating connector and only with facilities having a 30-amp capacity. Such facilities are available in most parks and campsites.

### CAUTION

USING YOUR POWER CORD WITH POWER SUPPLIES WHICH HAVE LESS THAN 30-AMP CAPACITY OR USING THE PLUG WITH RECEPTACLES FOR WHICH IT WAS NOT DESIGNED, MAY DAMAGE YOUR APPLIANCES AND MAKE THE WARRANTY INAPPLICABLE.



FIGURE 10 – 25-FT. ELECTRIC POWER CORD (Outside)

## 12-VOLT SYSTEM

When the power supply cord is not connected to a 115-volt ground source (or the generator power plant is not switched into the circuit), power for lights and appliances is automatically provided from your vehicle battery or from an auxiliary battery (if installed).

## 12-VOLT FUSES

The fuses for the 12-volt electrical system are located for easy access (see Figure 11). Certain models using

the optional 12-volt refrigerator may also have a fuse in the line supplying power to the appliance. Fuses for the mini home chassis circuit are located on a panel under the dash beside the steering column and Class "A" motor home fuse panel is located under front engine service door (see Figure 4 and Figure 2). See your Chassis Operator's Manual for further information. Optional equipment may have additional fuses installed: refer to the equipment instructions for information.

NOTE: If fuse replacement is necessary, replace with fuses of the same amperage.

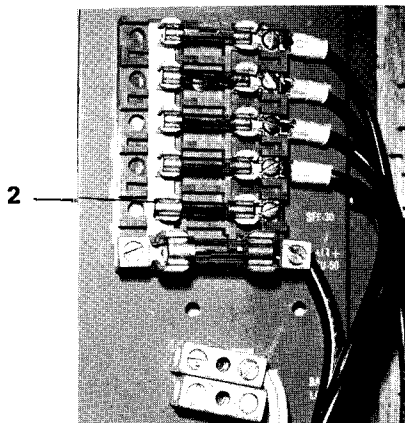

Class "A" Cruise Air.

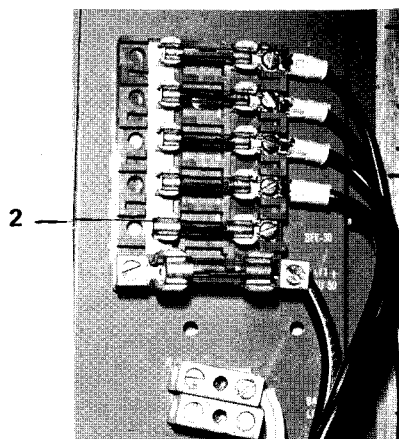
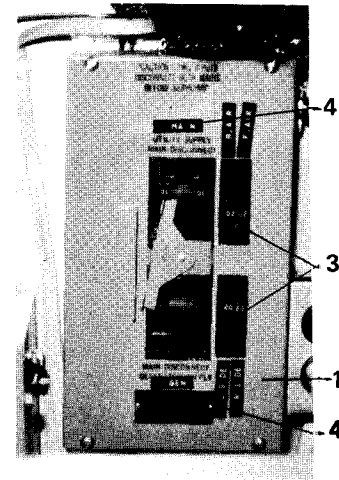

Cruise Air Minis

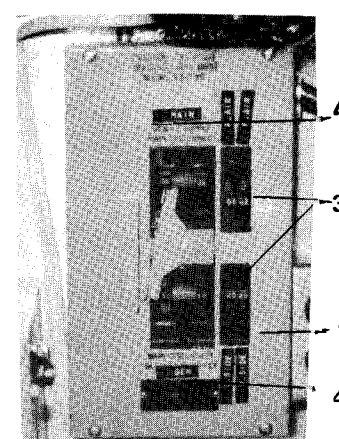

(INSIDE)

LIVING-AREA 12-VOLT  
FUSE PANEL

115-VOLT AC CIRCUIT  
BREAKER SWITCHES

(See Electrical Diagram for Additional Fuse Information)

1. Junction Box
2. Automotive-Type Fuses
3. 115-Volt Reset-Type Circuit Breakers
4. Circuit Identification

FIGURE 11 – TYPICAL ELECTRICAL  
CIRCUIT BREAKERS



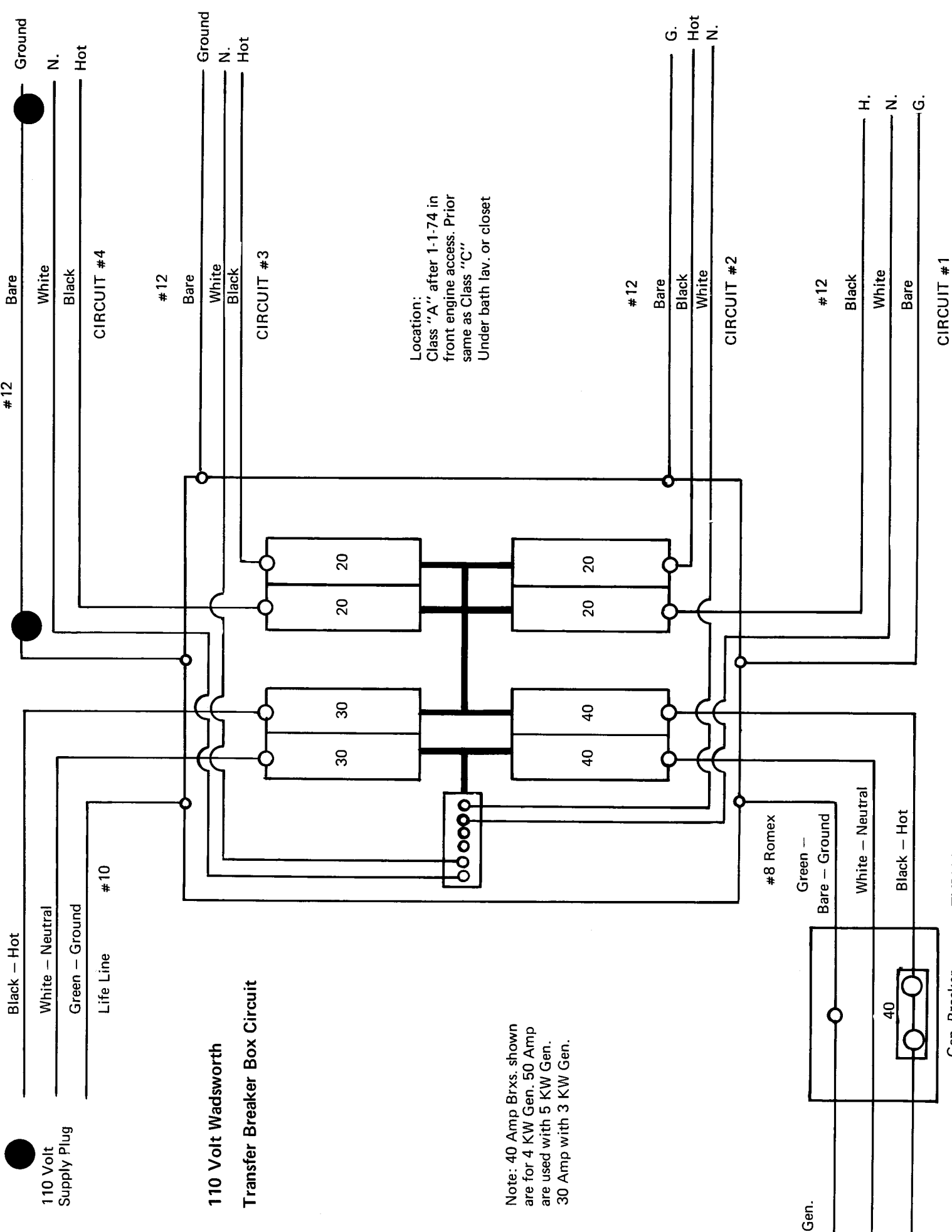

TYPICAL 115 VOLT CIRCUIT FOR MOTOR HOME AND MINI HOME

Located in front access

Triad TU-440-2 Converter

### Primary wiring for TRIAD Converter and Dual Batteries - Class "A" Cruise Air.

Triad TU-30 B Fuse Panel

Located in interior cabinets

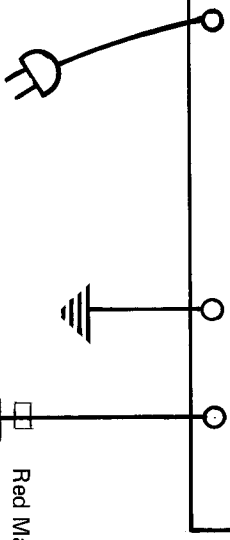
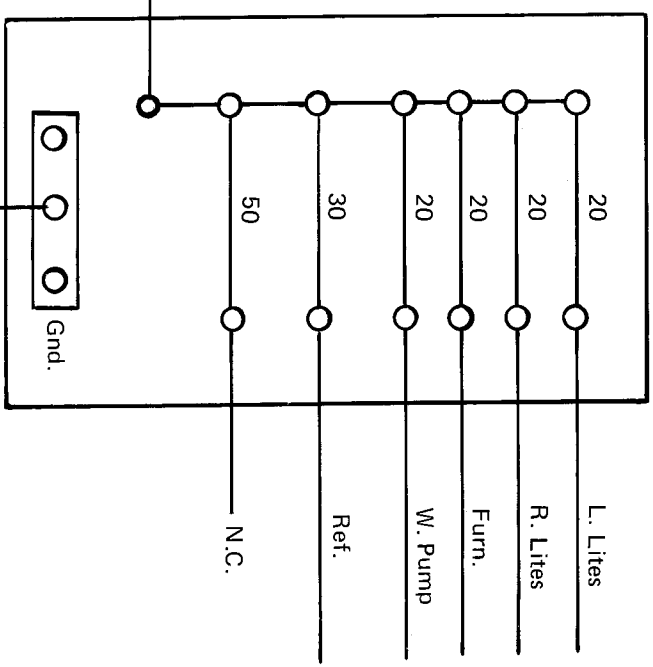

To 115V AC Outlet

To Ign Circuit # 16 Red

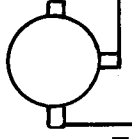

Black # 4

# 8 Black

# 8 Black

# 8 White

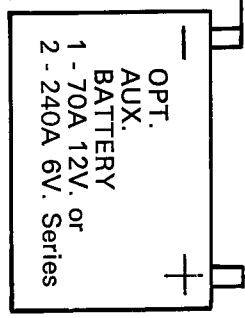
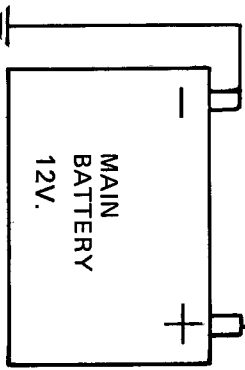

All ground connections at same point in front

**12 Volt Primary Wire Circuit — Dual Battery and 40A TRIAD Converter — Cruise Air Minis — Dodge only.**

Located in interior cabinets

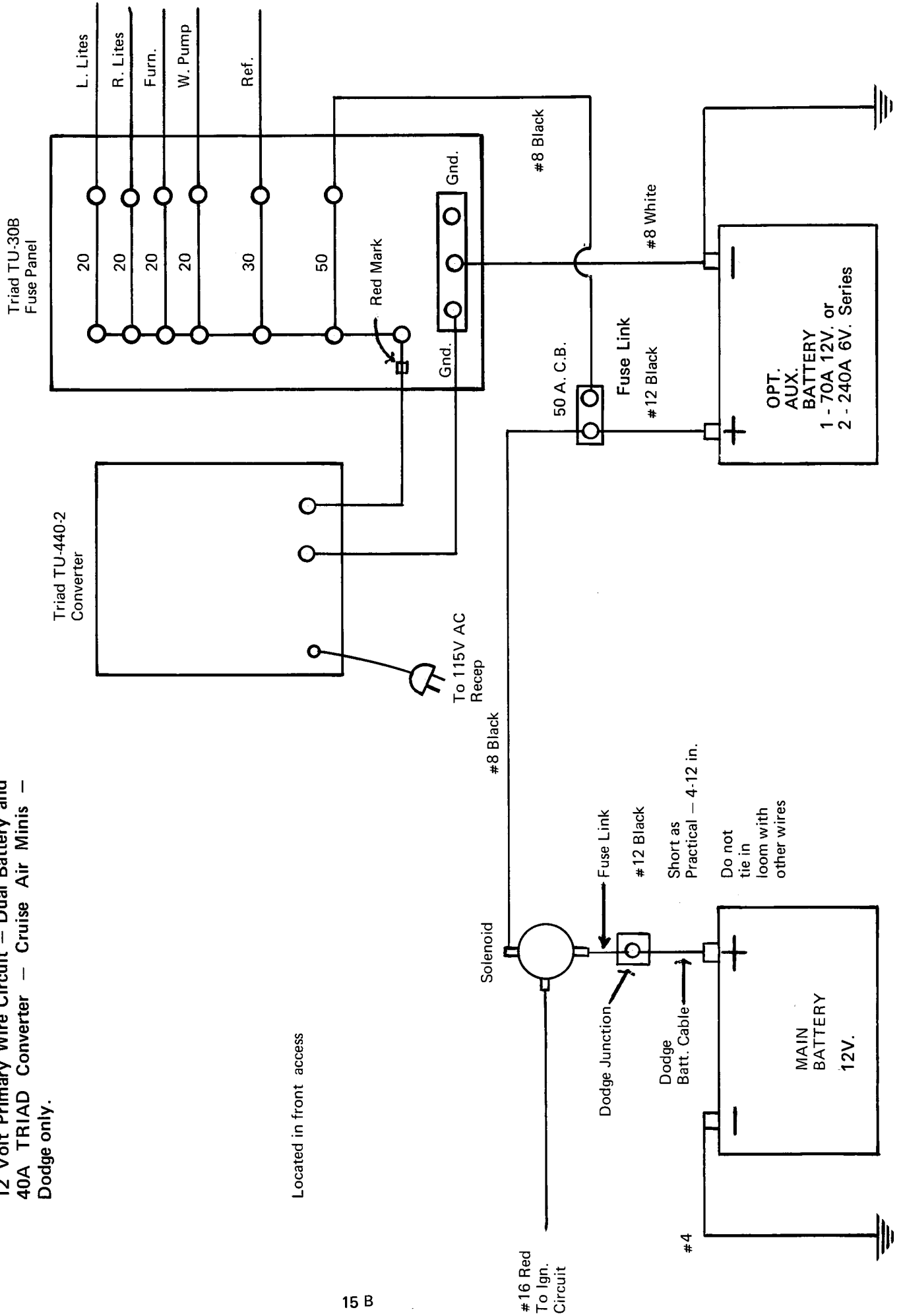

1 - 12V. @ 70A. or 2 - 6V. @ 240A AUXILIARY 12-VOLT BATTERY(S) (OPTIONAL)

The motor home is equipped with an auxiliary 12-volt battery. It will be installed in the location shown in Figure 1 and Figure 4. The auxiliary battery is the primary source for normal living-area power needs. Sensing and switching circuits permit the vehicle alternator to charge both batteries as required and prevent the living area 12-volt requirements from depleting the vehicle battery.

**NOTE:** All radio and tape decks draw from the vehicle battery and extended usage may deplete it.

#### AUXILIARY GENERATOR POWER PLANT (Optional)

The engine-driven 115-volt generator power plant (if installed) is located in a special compartment (see Figure 1). This generator option has a self-starting system which includes the auxiliary battery. Controls are at the generator and at a remote control panel located inside the motor home. Refer to Figure 12 for the generator power system and auxiliary control panel.

The 115-volt output of the generator is provided directly to the main circuit breaker panel which contains the transfer breakers. With the generator power plant operating and the generator breakers in the ON position, power is conducted through the circuit breaker panel to supply all of the 115-volt power requirements of the motor home, just as if the cord were connected to an external power source with the cord breakers in the ON position.

Gasoline for the generator is taken from the main fuel tank through a special feeder tube which is higher in the tank than the feeder tube to the motor home engine. This is to prevent immobilizing the motor home by accidentally permitting the generator to run the fuel tank dry.

**NOTE:** Refer to the Generator Power Plant Manufacturer's Instruction Manual (provided in your Owner's Information Kit) for service information before starting the generator. Do not start unit with a heavy power load. Always wait at least three minutes after starting generator before turning on (or plugging in) heavy electrical loads. (Example: When optional roof air conditioner is installed.)

To start the generator, hold the switch in the START position until the unit starts, then release the switch. If unit is slow to start, DO NOT hold the switch in the START position for more than 10 seconds. Release the switch, wait 15 seconds, then repeat. This

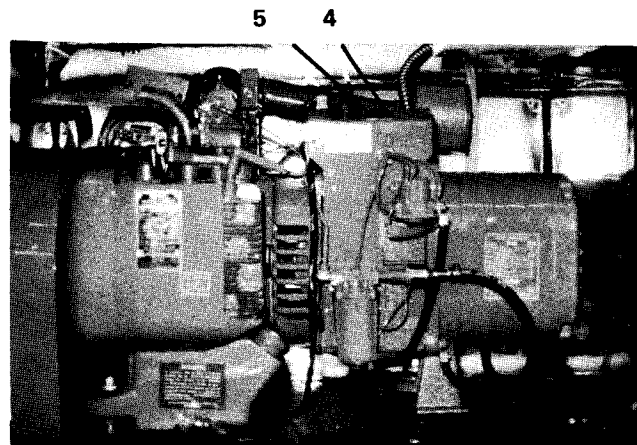

OUTSIDE POWER PLANT

1. Remote Indicator Light
2. Remote Start Switch
3. Hourmeter
4. Start Switch
5. Stop Switch

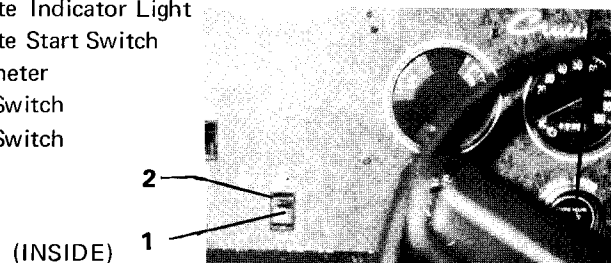

REMOTE START PANEL

**FIGURE 12 – GENERATOR POWER PLANT ENGINE SERVICE AREA (Optional)**

will help avoid overheating the generator starting motor and may prevent damage to the starting system. If this system fails to start, the generator manual starting instructions are indicated in the General Power Plant Manufacturer's Instructions. To stop the unit, hold switch to the STOP position until the engine stops operating.

A clock/meter is optional on the control panel located inside the motor home. This meter indicates the hours of running time on the generator. Operating-hours information is important in scheduling proper service maintenance for the generator.

#### ROOF AIR CONDITIONER (Optional)

Your motor home may have one or two air conditioners installed on the roof (see Figure 13) which use 115-volt power from the generator power plant or from the external power source, depending on system design. The air conditioner has three controls on the lower panel of the air conditioner, as shown in Figure 13. These are a blower switch, a thermostat, and an airflow direction control. A removable filter is located on the air conditioner panel inside the vehicle. For best results, carefully follow all instructions provided by the air conditioner manufacturer with regard to operation and maintenance.

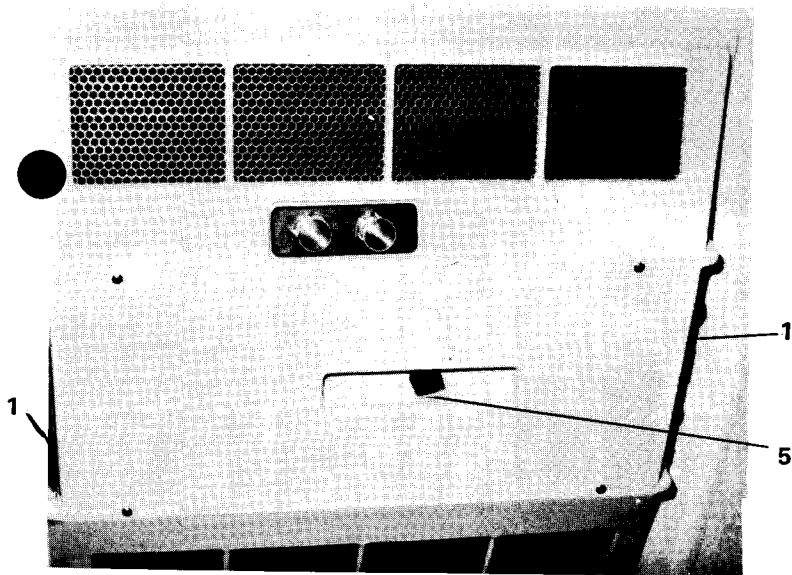

1. Directional Louver Control
2. Removable Air Filter (under grill)

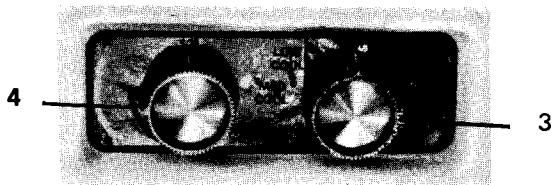

3. Blower Switch
4. Thermostat
5. Air Flow Control

**FIGURE 13 — TYPICAL ROOF AIR CONDITIONER**  
(Optional)

**CAUTION**

IF THE AIR CONDITIONER IS SWITCHED OFF FOR ANY REASON, WAIT A FEW MINUTES BEFORE STARTING IT AGAIN TO AVOID OVERLOADING CIRCUIT BREAKERS. SEE THE MANUFACTURER'S INSTRUCTIONS. WHEN AIR CONDITIONER IS NOT BEING USED, ALWAYS KEEP CONTROLS IN DEACTIVATED POSITIONS (WARM-OFF) TO REDUCE UNNECESSARY CIRCULATION OF REFRIGERANT.

Keep air filter screen clean and working properly, especially in dusty or dry areas.

**STANDARD AUTOMOTIVE AIR CONDITIONER**  
(Optional)

## LIQUID PETROLEUM GAS SYSTEM

Liquid Petroleum Gas (LPG) is the energy source for your range, oven, and furnace. It is also an alternate power source for your LPG/electric refrigerator.

LPG is a colorless gas, but is stored under pressure as a liquid. The tank is located under the frame accessible on the outside of the vehicle. It is commercially available under such names as Butane, Propane or other brand names. Though odorless in a natural state, LPG is always odorized to smell like garlic for easy detection in the event of a leak. The gas and the

For specific instructions, refer to the information provided by the air conditioner Manufacturer.

**CAUTION**

THE AUTOMOTIVE AIR CONDITIONER PLACES AN ADDITIONAL LOAD ON THE VEHICLE'S COOLING SYSTEM. IF ENGINE RUNS ABNORMALLY HOT, SHUT OFF AIR CONDITIONER UNTIL ENGINE COOLS DOWN.

**115-VOLT AC TO 12-VOLT DC CONVERTER**

A voltage converter is installed in your electrical system to supply 12-volt system requirements when the motor home is operating on 115-volt AC power. On mini homes and older Class "A" motor homes, it will be located in interior cabinets as shown in Figure 14. On later Class "A" motor homes, the TRIAD system will have a fuse panel located in interior cabinets while the converter will be mounted under the front engine access door (Figure 14)

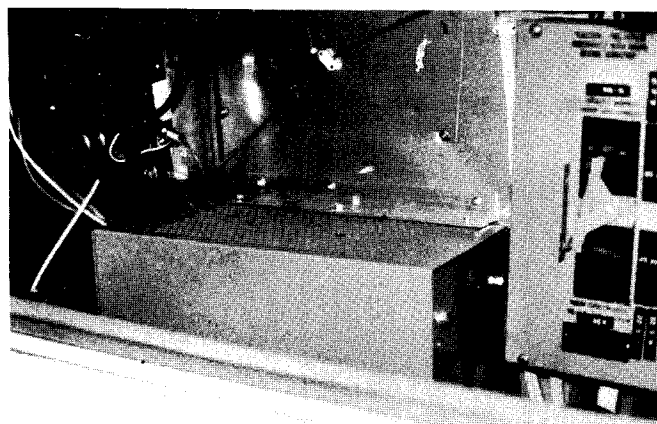

**FIGURE 14 — POWER CONVERTER**

**FIGURE 11 — FUSE PANEL LOCATION IN CABINETS**

When 115-volts are supplied from either an external power supply or the optional Auxiliary Power Generator, the converter will switch the load from the batteries to the converter.

A battery charger is installed with the converter, and 12-volt power requirements will be supplied automatically whenever 115-volt power is available to the converter and no switching is required. Auxiliary batteries will be brought up to full charge and maintained by the battery charger as long as 115-volt power is available.

liquid tank in which it is stored are safe and convenient, provided sensible precautions are followed (see Figure 15).

**CAUTION**

LPG GAS IS FLAMMABLE AND POTENTIALLY EXPLOSIVE. USE PROPER HANDLING, LIGHTING AND VENTILATING PROCEDURES. AS A GAS, LPG IS HEAVIER THAN AIR AND WILL DISSIPATE IF VENTILATION IS PROVIDED TO PERMIT A DOWNWARD FLOW.

## USING YOUR LP GAS SYSTEM AT LOW TEMPERATURES

Your gas system will function well at low temperatures, provided the components are kept at a temperature about the boiling point of the gas.

**NOTE:** Butane boils or turns to a gas about 32 degrees F and propane boils at about -40 degrees F.

The following are suggestions to keep gas appliances working smoothly:

1. Choose a type of LPG which has a boiling point lower than any temperature you expect to encounter. Ask your LPG supplier or your motor home dealer for information on products available in your area.
2. If outside temperatures get below the boiling point of the LPG in your system, keep exposed area (such as the tank, regulator and lines) at a higher temperature with a protective cover.
3. Keep the system free from water vapor (which may turn to ice in lines and regulators). Commercial additives such as dry methyl alcohol, added to the LPG tank, can help avoid water condensation in the regulator and the lines. Ask your LPG supplier or your motor home dealer.

If, despite precautions, the gas flow to your appliance should fail at low temperatures, the stoppage may be due to ice in the LPG regulator as a result of condensed moisture. Try melting the ice by warming the regulator; using a small light bulb on an extension cord - NOT AN OPEN FLAME. Once flow is restored, it may be necessary to protect the regulator or continue to provide a little heat in order to keep the moisture from freezing again. If the problem persists, ask your LPG supplier to service the tank or regulator, removing the moisture or adding an ice-inhibitor as required.

Your system may use LPG stored in a chassis-mounted tank (see Figure 15). The chassis-mounted tank has four controls; the gas pressure regulator, vapor withdrawal (service) valve, the fill valve and the gauge. To provide LPG to appliances, first open the vapor withdrawal service valve all the way (counterclockwise) then close it two-thirds of a turn. When all LPG systems are not in use, close the valve all the way.

### CAUTION

DO NOT USE PLIERS OR A WRENCH TO TIGHTEN VALVES. IF A VALVE IS NOT LEAK-TIGHT WHEN CLOSED BY HAND, SEE YOUR LPG GAS SERVICE REPRESENTATIVE. EXTINGUISH ALL PILOTS AND OPEN FLAMES. STOP THE ENGINE AND STOP THE AUXILIARY POWER GENERA-

TOR, IF INSTALLED, BEFORE FILLING LPG TANKS OR FUELING YOUR VEHICLE TANKS. PILOTS AND OPEN FLAMES SHOULD BE EXTINGUISHED WHEN THE VEHICLE IS UNDERWAY AND, BY REGULATION, MUST BE EXTINGUISHED IN CERTAIN AREAS SUCH AS TUNNELS OR RESTRICTED AREAS. CHECK AHEAD TO AREAS WHERE YOU PLAN TO TRAVEL TO DETERMINE ANY SPECIAL REGULATIONS WHICH MAY APPLY.

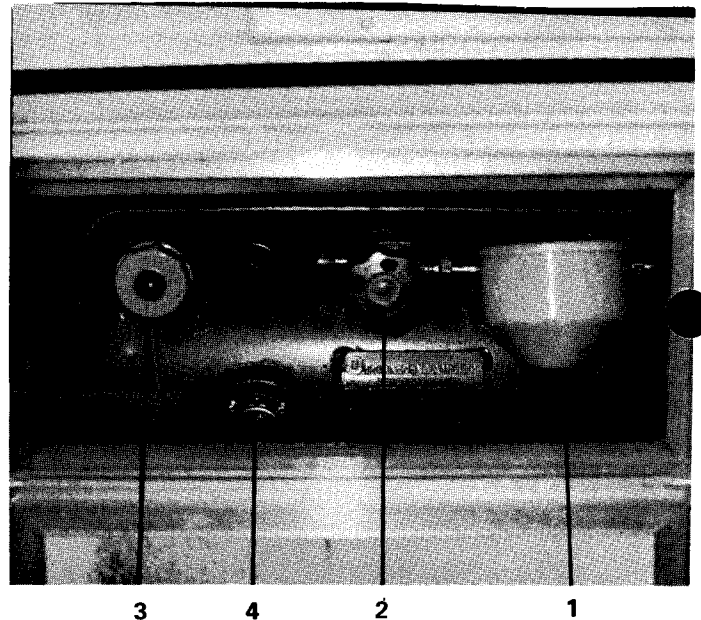

1. LP Gas Regulator
2. Supply Valve
3. Fill Valve or Plug
4. Quantity Gauge (if installed)

FIGURE 15 - TYPICAL LPG TANK

### FILLING THE CHASSIS-MOUNTED LPG TANK

For chassis-mounted storage tank, drive the vehicle to an LPG supplier or one of the service stations which sell LPG to have the tank filled. Look under Gas, Liquefied Petroleum, Bottled and Bulk, in your classified directory or refer to the service directory available at your dealer. For additional information refer to instructions for your gas appliances provided in your Owner's Information Kit.

## LPG SYSTEM LEAK CHECKS

For your safety, check for leaks in your gas system each time the tank is filled or before each trip. Always check the system any time the odor of garlic is detected. To perform a leak check, open the tank valve and spread a soap-bubble solution over all connections. Escaping gas will create visible bubbles to show the location of any leak.

### WARNING

NEVER CHECK FOR LEAKS WITH AN OPEN FLAME. IF THE LEAK CANNOT BE LOCATED, TAKE THE UNIT TO AN LPG SERVICE REPRESENTATIVE.

Keep the tank valve closed and turn OFF all appliances if the unit is not being used.

### LPG APPLIANCES

Your range top and oven, furnace, and water heater operate on LPG, while your refrigerator can operate on either LPG or electricity. Warranty certificate registration cards, service instructions, and other information are included in the Owner's Information Kit provided with the motor home. All information relating to your appliances should be kept readily available for easy reference.

NOTE: Be sure to fill out and mail the warranty registration cards on all appliances as soon as possible.

It is important to carefully follow all operating and lighting instructions provided on or near each appliance (or in your Owner's Information Kit). For the initial lighting of an LPG appliance, it may be necessary to purge the LPG supply line of air before the appliance will light. To purge a line, open a burner or a pilot valve and hold a flame near the burner. Allow time for air to escape. The time will vary depending on the distance the appliance is located from the LPG tank. After several seconds, the gas should ignite and burn steadily.

### RANGE TOP AND OVEN

The range top and oven in your motor home are provided with a vent or range hood. The hood has a power vent fan. Always use the fan when using the oven or range top in order to ensure adequate ventilation. When cooking for long periods of time with a large number of people in the home, it may be desirable to open a window or a roof vent slightly to further increase ventilation level.

### CAUTION

DO NOT USE OPEN FLAMES, SUCH AS THE OVEN OR RANGE TOP, TO WARM THE LIVING AREA BECAUSE GAS COMBUSTION CONSUMES THE OXYGEN INSIDE THE HOME.

The oven has a pilot light. Refer to information on the appliance or from the manufacturer for instructions on use. When using the oven pilot, note that the type of heat-actuated ignition control used for the main oven burner may result in a normal delay of a few seconds, after the oven control knob is turned ON, before the main oven burner ignites. If you are sure the pilot is burning, anticipate approximately five (5) seconds delay for the burner to ignite. If it doesn't ignite within five (5) seconds, turn the control knob OFF and check the pilot light or the supply.

### FORCED AIR FURNACE

Your motor home is equipped with a recirculating 12-volt fan and either a manual heat control setting or a forced-air ducted circulation system (see Figure 16). Controls will be on or near the furnace and will include a wall-mounted thermostat. The furnace will keep room temperatures at a comfortable level by activating fan and gas controls as temperatures inside the motor home vary. Refer to information on lighting, operation, adjustment, and service on the furnace case (under the inside access door).

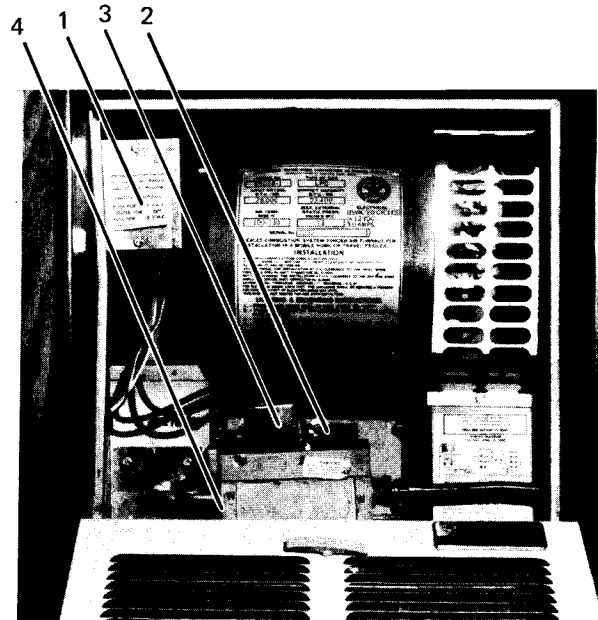

FORCED AIR FURNACE

1. Fan Switch (if provided)
2. Pilot/Flame Control
3. Temperature Control  
(or thermostatic sensor optional)
4. Lighting Port

FIGURE 16 – TYPICAL FURNACE

## WATER HEATER

Your motor home is equipped with an LPG-fueled water heater. The heater is a storage type much like that in your home. There is a thermostatic control on the heater to maintain the water temperature within a preset range. Before lighting the water heater, make sure that it is filled with water by turning on a hot water faucet such as the one at the galley sink. If water is supplied from the on-board fresh water tank, the pump must be ON. If water flows continuously, the heater is full of water. If water does not flow (and pressurized water is available), leave the faucet open until the tank fills. For lighting and operating instructions, refer to the manufacturer's instruction manual or see the instructions under the heater access panel (see Figure 17).

## LPG ELECTRIC REFRIGERATOR

Your refrigerator has separate controls for LPG fuel or electric power. Some models may operate on either 12 volts (optional) or 115-volt in addition to LPG gas. Consult the operating instructions furnished by the manufacturer in the manual and posted inside the refrigerator door. Before operating the refrigerator, be sure the vehicle is level. If it is not level, circulation of the refrigerant may be blocked by liquid accumulated in the condenser coils and cooling action could stop. Check the level at the refrigerator by placing a bubble-type leveling device (available from

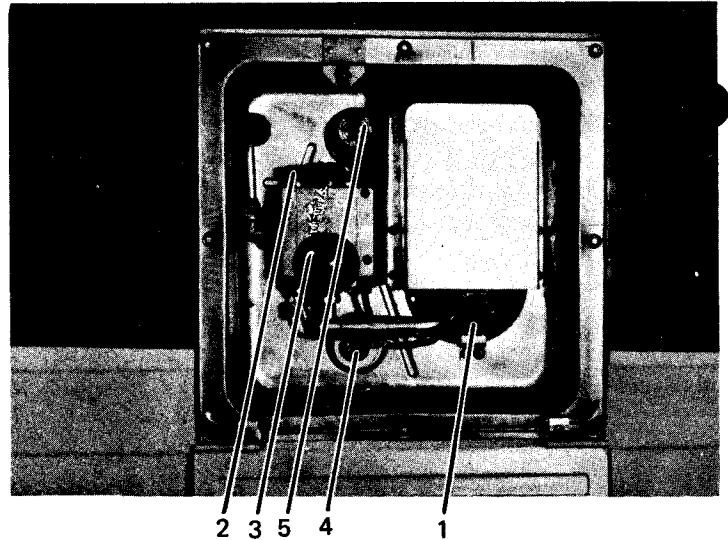

- |                        |                 |
|------------------------|-----------------|
| 1. Flame-Out Valve     | 4. Drain        |
| 2. Pilot-Light Control | 5. Relief Valve |
| 3. Heat Control        |                 |

NOTE: For gas appliance with flame-out valves; press while lighting and hold until flame stays lit when released.

FIGURE 17 – TYPICAL WATER HEATER

your dealer) on the freezer shelf. Adjust the level by jacking and blocking under the wheels.

NOTE: Unlike most household refrigerators, the refrigerator will be completely silent when operating on electric power.

# EQUIPMENT AND FURNISHINGS

## PEDESTAL SEATS

Pedestal seats may have two types of position controls. The seat can be moved forward or back by releasing the catch under the front of the seat. The seat may swivel in either direction by loosening the twist-lock on the side of the pedestal base. The arm rests fold down by lifting the arm rest, moving it forward and releasing. To return the arm rest to position, reverse the motion. Be certain that seat controls and locks are secure prior to driving the vehicle and never adjust the seat position while in motion.

## SPRING-BALANCED BUNK BEDS

Spring-balanced overhead bunks (optional) are located at the ceiling in the front and/or rear. These are moved into position simply by placing both hands on the center rim and pulling firmly down and forward (or down and back, for the rear bunk) against counter-tensioned springs. Be sure that fastener straps provided to hold the bunks in the UP position are properly snapped when traveling. Assure that sun

visors are down and out of the way before moving the front bunks down. When returning bunks to the raised position, be sure that no loose items which may strike the ceiling are on top of the bunk. The overhead bunk should not be used as a storage area.

## PEDESTAL DINETTE TABLES

To convert a pedestal-style dinette table into a bed, proceed as follows:

1. Remove the top by lifting the table evenly, at the same time giving a gentle twist or rocking motion to loosen the top of the pedestal.
2. Remove the pedestal from the socket with a lifting, turning motion (rocking the metal gently if necessary).
3. Store the pedestal in any of the convenient compartments or closets provided.
4. Place table top in position to complete base for bed.
5. Slide seat and back cushions into place over bed area.



## FLIP UP GAUCHO BEDS

To convert Flip-Up Gaucho Seat into a bed, proceed as follows:

1. Pull up hinged front, by pulling it out and up from bottom.
2. Unfold metal legs to support outside edge.
3. Arrange the cushions by putting the back cushion down in place to make a bed.

## DINETTE BED

A combination dinette and bed may be provided on the passenger side near the driver's compartment. This dinette combination may be converted into a bed as follows:

1. Fold the table leg by releasing the catch. Relocate the table by lifting the end (to release from the support brackets). Let the table, with the leg folded, drop into down position.
2. Arrange cushions to make a bed.

## STORAGE

Storage facilities on your motor home have been es-

pecially designed to remain secure while the vehicle is in motion. Exterior compartments have key-operated locks except for the LPG compartment, which is required by fire-preventive regulations to be unlocked at all times. Drawers rest in small notches or detents when closed; to open, lift slightly to clear the detent, then pull open normally. For best results, follow a few simple rules when stowing articles in the motor home.

1. Always keep tools and equipment stored in areas where they will not shift while traveling.
2. Wherever possible, place heavy articles in storage compartments which are low and between the axles for better weight distribution.
3. Use a "packing" technique of the articles in a compartment to prevent shifting. If necessary, secure articles with strap to prevent movement.
4. Be sure that containers holding liquids are capped and cannot tip or spill. When glass containers (or dishes) are transported, secure them well to protect against accidental breakage.

# CARE AND MAINTENANCE

## INTERIOR CLEANING

### Draperies, Cushions and Upholstery Fabrics

The furniture and decor of your motor home use materials and fabrics, often synthetics, which require only the simplest care. Before using a cleaning product on fabrics, always check the labels to identify the materials, then use the products recommended for that material. If the labels do not specify otherwise, drapes and cover fabrics must be dry cleaned. Vinyl fabrics may be cleaned using a mild detergent and a damp sponge or cloth.

### Wall Paneling

The paneling and the ceiling of your motor home may be any of several finishes and textures. Never use strong detergents or abrasive cleaners on walls or ceilings. Most surfaces will clean with a soft cloth which has been dampened with mild liquid detergent in warm water; avoid the use of large amounts of water. Many panel suppliers suggest that one of the aerosol products designed for cleaning and preserving wood surfaces may be excellent for walls if used in accordance with manufacturer's instructions.

### Carpeting

Use any approved cleaning product or procedure

which is recommended for cleaning indoor type carpets.

### Fixtures

Sinks, baths, showers or other fiberglass fixtures should be cleaned only with warm water and mild detergent or special cleaners — harsh abrasives may scratch or discolor the surface, causing it to have to be refinished or replaced. It is recommended that NO ammonia or cleaner with ammonia in it, be used on fiberglass. Should a fiberglass surface become chipped or scratched, it can be often repaired successfully by your local serviceman. Minor repairs can often be done by home owners themselves using repair kits available in a variety of colors and finishes at most hardware or paint stores.

### Windows

Moving parts of windows and latches should be kept adjusted and maintained. It is advisable to lubricate the windows with a light oil or powdered graphite at least once a year. The screws holding the windows in place should be checked and tightened periodically and the weather sealant checked for voids. Screens may be cleaned by gently wiping with a damp cloth or soft flat brush designed for the purpose.

## Locksets and Latches

Annual lubrication of locksets and latches is recommended to ensure trouble-free operation. If your motor home is located at the beach or is exposed to salt air, more frequent lubrication may be needed. One of the lubricants recommended by many locksmiths is powdered graphite, available in a handy tube at most hardware or supply stores.

A record should be kept of the identification number of keys, with the make of lockset in your home. With this information alone it will be possible to obtain duplicates for any key that might be lost.

## PLUMBING

The water supply plumbing should require little, if any maintenance. Refer to information provided by the water pump manufacturer for any special maintenance recommendations on the pump mechanism. Refer to the recommendations from the toilet or tank manufacturer relating to maintenance or to chemical additives which may be appropriate for those components. Plumbing system drains and traps should be kept clean. Chemical products recommended for plastic pipe may be used in the drain lines. Precautions must be taken when using a mechanical device to remove obstructions from a drain line, to avoid damage to fittings and seals.

## CONDENSATION AND VENTILATION

It is important that moisture-laden air not be allowed to build-up inside your motor home. Moisture build-up is often evident from the forming of a water film on windows and other cooled surfaces. Particular precautions may be appropriate in kitchen or bath areas where normal washing or cooking activities can release water vapor or steam into the air. The following steps are recommended.

1. Keep air circulating by providing ample fresh air through adequate ventilation.
2. When using shower, keep the bath vent open. Keep bathroom door closed for 20 or 30 minutes after use to permit moisture to escape through the vent.
3. Avoid hanging wet clothing to dry inside the motor home. If it cannot be avoided, use the ventilated bath with the door closed.

## EXTERIOR CARE

### CAUTION

WHEN WASHING MOTOR HOME DO NOT USE HIGH PRESSURE HOSE OR STEAM CLEANING PROCESSES AS THIS MAY LOOSEN DECORATIVE STRIPING. USE CITY WATER AND MILD DETERGENT ONLY

### Exterior Metal and Trim

The exterior finish on your motor home is as easy to care for as the finish on your car. To keep it clean, simply hose it down with water, wiping the wet surface with a cloth or sponge if necessary. Never wipe the metal surface when it is dry. Do not use harsh abrasives or strong solvents on exterior surfaces.

Accumulated dirt or road film resulting from storage or from heavy travel should loosen easily with warm water and a mild detergent. Rinse with plain water. Application of a good quality automotive wax will protect the finish still more and add lustre to the color.

### Roof

The metal adhesives and sealants used to construct your metal roof have been chosen especially to remain waterproof under the sustained effects of weather and vibration. Periodically, inspect the roof with careful attention as to possible scrapes or dents caused by over-hanging obstructions. Wash dirt and grime from the roof when washing the motor home to help minimize oxidation of the roof materials, then apply one of the roof sealing compounds available from your dealer or from trailer supply stores to any dents, nicks or holes.

### Repairs

Your dealer should be able to perform most repairs or service required for your motor home. Repair or service for warranted appliances in your motor home will normally be handled through the appliance manufacturer in accordance with warranty instructions provided in the owner's kit. Your dealer will be glad to assist, if you have difficulty obtaining service through your appliance service representative.

Refer to Your Chassis Operator's Manual and to other information provided by the chassis manufacturer for chassis service instructions.

Repair of glass, fiberglass, aluminum or some plastic components can often be accomplished by camper/trailer service firms or by automobile body shops. Check with your dealer or look in the Classified Section of your telephone directory or newspaper.

It is recommended that all chassis body bolts be checked once a year for tightness to prevent rattling due to vibration.

## LIMITED WARRANTY

### SUMMARY OF WARRANTY

Georgie Boy Manufacturing, Inc., May Road, Industrial Park, Edwardsburg, Michigan 49112 ("Warrantor") warrants to the ORIGINAL CONSUMER PURCHASER for a period of ONE (1) YEAR from the date of purchase by the original purchaser, or for the first Twelve Thousand (12,000) miles of operation, whichever occurs first (Warranty Period), that this motor home shall be free of SUBSTANTIAL DEFECTS in materials and workmanship attributable to Warrantor in the BODY STRUCTURE ONLY. This Warranty only covers components and parts of the body structure manufactured and assembled by Warrantor.

### TYPES OF THINGS EXCLUDED FROM WARRANTY

By way of illustration, Warrantor is not responsible for claims relating to the following: (1) defacing: scratches, dents chips and defacing on any surface or fabric of this motor home, not caused by Warrantor; (2) routine maintenance: including recaulking the body of the motor home, tightening screws, adjusting doors, and maintaining the air conditioning; (3) the chassis and any mechanical parts of this motor home: including any parts of the engine, drive train, steering mechanism, brake system, wheel balance, mufflers, tires, tubes, batteries and gauges; (4) lighting: bulbs, fixtures, shades and lenses; (5) glass: mirrors, reflectors, window frames and window glass, and screens; (6) fire extinguishers; (7) cabinet and other knobs and pulls, switches, toggles; (8) fuses, converters and circuit breakers; (9) valves: city water check valve, dump valve; (10) hinges; (11) all appliances: including air conditioners, water heaters, ovens and ranges, refrigerators and furnaces; (12) all furniture and carpeting; (13) radios, tape decks and speakers; (14) compressors.

### WARRANTOR'S OBLIGATIONS

Warrantor will remedy substantial defects in materials and workmanship caused by Warrantor in the BODY ONLY of this motor home. Warrantor shall elect to remedy the defect from among the following: repair, replacement or refund. Warrantor may not elect refund unless the purchaser agrees, or the Warrantor is unable to provide replacement and repair is not commercially practicable or cannot be timely made. Warranty performance can only be obtained at Warrantor's authorized dealers and service centers and from Warrantor. All costs incurred in transporting this motor home for warranty service shall be borne by purchaser. Warrantor shall remedy the defect within a reasonable time, not to exceed thirty (30) days after delivery by Purchaser. All Warrantor's expenses in remedying the defect shall be borne by Warrantor.

### PURCHASER'S OBLIGATIONS

Purchaser must return the owner's registration card within ten (10) days of purchase to validate this Warranty. Purchaser shall deliver this motor home for warranty service within a reasonable time after discovery of the defect and in no event later than thirty (30) days after expiration of the ONE (1) YEAR warranty period. All expenses incurred by purchaser in obtaining warranty service shall be borne by Purchaser. Purchaser can obtain a list of persons authorized to perform warranty service by contacting Warrantor at the above address.

### EVENTS DISCHARGING WARRANTOR FROM OBLIGATION UNDER THIS WARRANTY

Misuse or neglect, including failure to provide reasonable and necessary maintenance, unauthorized alteration, accident, and improper loading, shall discharge Warrantor from any obligation under this Warranty.

### DISCLAIMER OF CONSEQUENTIAL AND INCIDENTAL DAMAGES

THE ORIGINAL PURCHASER OF THIS MOTOR HOME AND ANY PERSON TO WHOM THIS MOTOR HOME IS TRANSFERRED, AND ANY PERSON WHO IS AN INTENDED OR UNINTENDED USER OR BENEFICIARY OF THIS MOTOR HOME, SHALL NOT BE ENTITLED TO RECOVER FROM WARRANTOR ANY CONSEQUENTIAL OR INCIDENTAL DAMAGES RESULTING FROM ANY DEFECT IN THE MOTOR HOME.

SOME STATES DO NOT ALLOW THE EXCLUSION OR LIMITATION OF INCIDENTAL OR CONSEQUENTIAL DAMAGES, SO THE ABOVE LIMITATION OR EXCLUSION MAY NOT APPLY TO YOU.

### LIMITATION AND DISCLAIMER OF IMPLIED WARRANTIES

WARRANTOR EXPRESSLY LIMITS WITH RESPECT TO THE MOTOR HOME THE DURATION OF ALL IMPLIED WARRANTIES OF MERCHANTABILITY AND ALL IMPLIED WARRANTIES OF FITNESS FOR A PARTICULAR PURPOSE TO THE WARRANTY PERIOD OF ONE (1) YEAR. WARRANTOR EXPRESSLY DISCLAIMS WITH RESPECT TO THIS MOTOR HOME ALL IMPLIED WARRANTIES OF MERCHANTABILITY AND ALL IMPLIED WARRANTIES OF FITNESS FOR A PARTICULAR PURPOSE AFTER EXPIRATION OF THE WARRANTY PERIOD. THERE IS NO WARRANTY OF ANY NATURE MADE BY WARRANTOR BEYOND THAT CONTAINED IN THIS WARRANTY. NO PERSON HAS AUTHORITY TO ENLARGE, AMEND OR MODIFY THIS WARRANTY.

SOME STATES DO NOT ALLOW LIMITATIONS ON HOW LONG AN IMPLIED WARRANTY LASTS, SO THE ABOVE LIMITATION MAY NOT APPLY TO YOU.

### PARTS AND DESIGN CHANGES

Warrantor reserves the right to change the parts and design of its motor home from time to time without notice and with no obligation to maintain spare parts or to make corresponding changes in its products previously manufactured.

### LEGAL REMEDIES OF PURCHASER

THIS WARRANTY GIVES YOU SPECIFIC LEGAL RIGHTS, AND YOU MAY ALSO HAVE OTHER RIGHTS WHICH VARY FROM STATE TO STATE. No action to enforce this Warranty shall be commenced later than six (6) months after expiration of the warranty period.

### REGISTRATION CARD

Return of the registration card is required by Warrantor for Warranty coverage and performance. RETURN OF THE REGISTRATION CARD IS REQUIRED WITHIN TEN (10) DAYS OF PURCHASE OF THIS MOTOR HOME BY THE ORIGINAL CONSUMER PURCHASER, OR ELSE THIS WARRANTY IS VOID.

