

OWNERS MANUAL

Motorized Recreational Vehicles

Class A
Mini





FOREWORD

This Owner's Manual has been prepared to help you and your family enjoy your new Shasta RV to its fullest, by providing basic instructions for the operation and maintenance of its appliances, accessories and RV systems. Read it carefully and follow the instructions. Also, read and follow the instructions contained in the appliance and accessory instruction booklets provided by various manufacturers which are a part of the Shasta Information Packet.

Operating and maintenance instructions pertaining to appliances in this Owner's Manual were obtained from and are used with the permission of the various manufacturers. We reserve the right to present edited portions of their material.

Shasta works year 'round to improve its products. Accordingly, all specifications, equipment, and prices set forth in Shasta literature are subject to change without notice or obligation.

Shasta offers a wide variety of recreational vehicle models and choices of standard and optional equipment; therefore, certain descriptions in this manual may not apply to your unit. Ask your Shasta dealer, or see the current brochure, for information concerning available standard or optional equipment.

Welcome To *Wings of Shasta*



Exclusive Travel Club for Shasta Owners.

This is a special invitation for you and your immediate family to join the VIPs (Very Important Participants) of the *Wings of Shasta*. As the owner of a new Shasta RV you qualify for one free year membership.

Wings of Shasta! What does it mean? In two words the answer is: MORE FUN! More fun with your Shasta recreational vehicle. We know you're having fun with it now, but we assure you, you'll have even more when you join with a group of people who, like you, own Shastas. People who like to go together and be together on trips, at weekend campouts and at rallies.

Please enroll me for my FREE one-year membership
INTERNATIONAL WINGS OF SHASTA MEMBERSHIP APPLICATION

Name _____ Spouse's Name _____
 Address _____ City _____ State _____ Zip _____
 Telephone _____ Dealer's Name _____
 Type/Model RV _____ Serial # _____
 Year _____ Length _____

SUBSEQUENT OWNER INFORMATION

If you are the second or subsequent owner of this recreational vehicle, it is important that you notify the manufacturer of your name, address, date of purchase and the Serial Number of your RV. This information is vital for the manufacturer to maintain up-to-date records of current ownership. See the warranty explanation in the WARRANTY section of this manual. Complete one of the forms below, clip it, place it in an envelope and mail it to the manufacturer at the address listed on the back of this manual. If no forms remain, print the words, "Subsequent Owner" along with your name, address, date you purchased the vehicle, and the RV's Serial Number on a post card, and mail it to the manufacturer.

.....
 cut along dotted lines

DATE OF PURCHASE _____ RV SERIAL NUMBER _____
 YOUR NAME _____
 ADDRESS _____
 CITY _____ STATE _____ ZIP _____
 NAME OF FORMER OWNER _____

.....
 cut along dotted lines

DATE OF PURCHASE _____ RV SERIAL NUMBER _____
 YOUR NAME _____
 ADDRESS _____
 CITY _____ STATE _____ ZIP _____
 NAME OF FORMER OWNER _____

.....

DATE OF PURCHASE _____ RV SERIAL NUMBER _____
 YOUR NAME _____
 ADDRESS _____
 CITY _____ STATE _____ ZIP _____
 NAME OF FORMER OWNER _____

.....

DATE OF PURCHASE _____ RV SERIAL NUMBER _____
 YOUR NAME _____
 ADDRESS _____
 CITY _____ STATE _____ ZIP _____
 NAME OF FORMER OWNER _____

People make the difference. The joy of sharing adventure and good times with your fellow campers is the extra you get from your *Wings of Shasta* membership.

Through your membership with Shasta's travel club you will be eligible to participate in the various International activities, *Shafari* trips and the annual International Rally. All programs are carefully planned and supervised by the International Director and his experienced staff. Additional benefits to members are many and are fully outlined in the kit you will receive. Our newspaper, the *Shafari Drummer*, will keep you informed of club activities, and the Old Fort Shasta Trading Post can provide the personalized items that proudly proclaim your association with our select group.

That's not all. The *Wings of Shasta* is also organized into local Wings (chapters), which set their own dues and plan their own campouts and trips. If you are not aware of a Wing in your area, we will assist you in locating one.

Upon receiving your application, we will forward your member's kit, including your membership card and your *Wings of Shasta* decals and unit numbers. These are important items to identify you as a full-fledged member.

We invite you to apply for membership now. Please complete the attached application and mail it to our International Headquarters. If you have never enjoyed "The Great American Get-Away" in an RV and have not been able to see all the beauty our country has to offer, you are in for a real treat.

Fill in information on reverse side, cut along dotted line and mail to:

International Headquarters
Wings of Shasta
P.O. Box 631
Middlebury, Indiana 46540
Attn: Membership Director

cut along dotted lines

Subsequent owner:

Clip and Mail Completed Form in an envelope to the manufacturer, at the address listed on the back of this manual.

cut along dotted lines

Subsequent owner:

Clip and Mail Completed Form in an envelope to the manufacturer, at the address listed on the back of this manual.

Subsequent owner:

Clip and Mail Completed Form in an envelope to the manufacturer, at the address listed on the back of this manual.

Subsequent owner:

Clip and Mail Completed Form in an envelope to the manufacturer, at the address listed on the back of this manual.

TABLE OF CONTENTS

APPLIANCES AND ACCESSORIES	23	Shoreline Connection	17
Range, Range Hood, Oven	23	Generator	17
Water Heater	24	12-Volt System	18
Furnace	25	Converter	18
Refrigerator	26	EXTERIOR COMPONENTS	42-43
Roof Air Conditioner	27	FEDERAL STICKER	7
AM/FM Radio, Tape Player	28	FIRE SAFETY	31
TV Antenna	28	FRESH WATER SYSTEM	18
Security System	28	City Water	18
LP Leak Detector	28	Water Tank	19
Hydraulic Levelers	28	Water Pump	19
Vacuum Cleaner	29	Sinks	19
Food Center	29	Leaks	19
Battery Disconnect	29	Water Purifier	19
Ice Maker	29	Exterior Shower	19
Digital Clock	29	GENERATOR	17
Electric Step	29	INSURANCE	5
APPLIANCE IDENTIFICATION FORM	40	LEVELING	12
BASIC SYSTEMS	16	LP GAS SYSTEM	21
Electrical System	16	Climate Differences	22
Fresh Water System	18	Regulator Pressure	22
Drainage/Sewer System	20	Regulator Freeze Ups	22
LP Gas System	21	Filling LP Gas Tank	22
CAMPING	11	LP Gas Line Check	22
CONDENSATION	12	LICENSES	5
DRAINAGE/SEWER SYSTEM	20	LIVING AREA	12
Toilet	20	LOADING	7
Holding Tanks	20	MAINTENANCE	32
DRIVING	8	MAINTENANCE SCHEDULE	39
Clearance	8	PRE-TRAVEL CHECK	34
Pulling Into Traffic	8	SMOKE DETECTOR	31
Passing	8	STORAGE	29
Braking	9	TRAVEL PREPARATION CHECKLIST	36
Swaying or Fishtailing	9	TROUBLE SHOOTING	37
Turning	9	VISITING CANADA OR MEXICO	6
Backing	9	WARRANTY	2-3
Downgrades	9	WEIGHT DETERMINATIONS	7
Upgrades	9	WEIGHING	8
Overheating	9	WINTERIZATION	30
Parking On A Grade	9	REPORTING SAFETY DEFECTS	38
Holding On An Upgrade	9		
Freeing A Stuck Vehicle	10		
Speed Controls	10		
Tire Change	10		
Dash Instrument Controls	10		
Tilt Steering Wheel	11		
ELECTRICAL SYSTEM	16		
Dash Fuse Panel	16		
120-Volt System	16		
Ground Fault Interrupter/Receptacle	16		



SHASTA

NEW RECREATIONAL VEHICLE LIMITED WARRANTY

WHAT WE WILL DO

Shasta Industries will, for one year from the retail purchase date, or for the first 15,000 miles of use, whichever comes first, make repairs which are necessary because of defects in material or workmanship. We will repair or replace any defective part at no cost to you. Because of design changes and improvements, we may substitute parts or components of substantially equal quality. This warranty covers only you, as the first retail purchaser of our new product, and only products purchased new from an authorized Shasta dealer.

WHAT YOU MUST DO

For warranty service, take the product, at your expense, to an authorized dealer or service center and present your Owner Registration or Temporary Owner Registration Card.

WHAT IS NOT COVERED

Automotive chassis, tires, batteries, optional television sets, video cassette recorders, or generators which are warranted separately by their manufacturers.

Damage such as that caused by misuse, abuse, collision, alterations, lack of proper maintenance, improper repairs or environmental damage.

Normal deterioration of fabric and decorative items due to wear or exposure.

Any product which is used for commercial purpose or held for rental.

Any product which is not used for its customary purpose.

Maintenance service—it is your responsibility to maintain the product in accordance with the instructions provided in the owner's manuals.

Any product which is not registered and normally used in the United States or Canada.

Any promises made by any person beyond those stated in this warranty.

WE SHALL NOT BE LIABLE FOR INCIDENTAL OR CONSEQUENTIAL DAMAGES, such as your expenses for transportation, lodging, loss or damage to your personal property, loss of use of your product, inconvenience, or loss of income. Some states do not allow exclusion or limitation of incidental or consequential damages, so the above limitation or exclusion may not apply to you.

IMPLIED WARRANTIES, INCLUDING ANY WARRANTY OF MERCHANTABILITY OR FITNESS FOR A PARTICULAR PURPOSE, ARE LIMITED IN DURATION TO THE TERM OF THIS WRITTEN WARRANTY. Some states do not allow limitations on how long an implied warranty lasts, so the above limitation may not apply to you.

This warranty gives you specific legal rights, and you may also have other rights which vary from state to state.

We want you to be satisfied with your new product. For further help or information, contact: SHASTA INDUSTRIES, SERVICE DEPARTMENT, P.O. BOX 631, MIDDLEBURY, INDIANA 46540.

OUR WARRANTY

GENERAL — Your new recreational vehicle is backed by our position as an industry leader, achieved through decades of experience in producing RV's noted for their quality and dependability. Our one-year warranty demonstrates our confidence in our products and is a commitment to customers' continued satisfaction.

Every effort has been made to provide you with a safe, dependable recreational vehicle. Your RV complies with applicable federal and state regulations and the requirements of ANSI A119.2, the nationally recognized "Standard for Recreational Vehicles — Installation of Plumbing, Heating and Electrical Systems". The Recreation Vehicle Industry Association (RVIA) periodically inspects our production and assists in maintaining strict compliance with installation and safety standards for those systems. Similar periodic inspections of the systems are made by representatives of various states. You, the owner, must perform periodic inspections of the systems and provide a program of preventive maintenance as described in the Owner's Manual and instruction booklets.

WARRANTY SERVICE — We recommend that warranty service be performed by the authorized dealer from whom you purchased your RV because of the dealer's continued and personal interest in your satisfaction. But if you are traveling or in the event that you move, service under the warranty will be performed by any of our authorized dealers. Whenever possible, make an appointment to avoid unnecessary delays.

Always carry your Owner Registration Card, which must be presented to obtain warranty service. The card is proof of purchase and provides the date of retail sale, which are necessary to determine warrantability. If you cannot locate an authorized dealer, contact our Service Department at the address on the back of this manual.

WARRANTY PERIOD — The warranty period shall be for 12 months or the first 15,000 miles of use, whichever comes first, and begin on the date the new recreational vehicle is delivered to the first retail purchaser, or the first in-service date, whichever is first.

WHO IS COVERED — The first retail purchaser, provided terms of the warranty are met.

WHAT IS COVERED — The Manufacturer warrants to owners that an authorized dealer or Service Center will make repairs made necessary by defects in material or workmanship during the warranty period. Such repairs will be made without charge for parts and labor to the owner.

WHAT IS NOT COVERED — Our warranty does not cover the motor home chassis, tires, tubes, batteries, optional TVs or video cassette recorders and generators, repairs or adjustments required because of neglect, accident, misuse, failure to follow service and use instructions, normal wear and/or exposure, unauthorized repairs or unauthorized modifications to any part of the systems or body that might cause defective performance.

Your new recreational vehicle is designed as a temporary living quarters for recreational camping, travel or seasonal use and not as a permanent dwelling place. Usage as a permanent accommodation is a breach of warranty and we are not liable for any damage that results because of such misuse.

The manufacturer does not assume responsibility for loss of use of the recreational vehicle, loss of time, inconvenience or expenses due to equipment failures (refer to the warranty statement for other exclusions and limitations).

OTHER WARRANTIES — Be certain to complete and submit to the appropriate manufacturers the warranty forms for tires, tubes, batteries, and optional TVs and generators, which are not covered by our one-year warranty. If service or parts are required for these products, refer to the furnished list of factory-authorized service centers. If the list is not available, write or call the manufacturer concerned to obtain the location of the nearest authorized service center.

OWNER RELATIONS — Owner satisfaction and goodwill are of primary concern to us. We recognize that our continued success as a leading manufacturer of recreational vehicles depends upon your complete confidence in our products and service. A pleasant and effective relationship through our dealers is as important as maintaining the technical excellence of our product. Your authorized dealer will assist you in providing service, maintenance, selection of options and instructions concerning the operation of your recreational vehicle.

Occasionally, a warranty or service matter may not be handled to your satisfaction. Often it is the result of a misunderstanding and can be resolved at the dealer level. Discuss the situation with the dealership management. If you cannot find satisfaction at the dealer level, we invite you to contact our Owner Relations Department, where we will make every effort possible to provide an agreeable solution. In most instances, we will eventually refer you back to the local dealer with our recommendations.

Write or telephone Owner Relations at the address or telephone number on the back of this manual.

SAFETY REGULATIONS REGARDING LP GAS SYSTEMS AND LP GAS APPLIANCES

The manufacturer of this recreational vehicle is required to furnish the following consumer information as provided by the National Fire Prevention Association and the American National Standards Institute. The information and warnings found here may also be found in other sections of this Owner's Manual. Please see sections titled "Liquid Petroleum Gas System" and "Appliances" for other safety and operating information.

WARNING

LP gas containers shall not be placed or stored inside the vehicle. LP gas containers are equipped with safety devices which relieve excessive pressure by discharging gas to the atmosphere.

WARNING

It is not safe to use cooking appliances for comfort heating. Cooking appliances need fresh air for safe operation. Before Operation:

1. Open overhead vent or turn on exhaust fan, and
2. Open window.

This Warning Label has been located in the cooking area to remind you to provide an adequate supply of fresh air for combustion. Unlike homes, the amount of oxygen supply is limited due to the size of the recreational vehicle, and proper ventilation when using the cooking appliance(s) will avoid dangers of asphyxiation. It is especially important that cooking appliances not be used for comfort heating as the danger of asphyxiation is greater when the appliance is used for long periods of time.

WARNING

Portable fuel-burning equipment, including wood and charcoal grills and stoves, shall not be used inside this recreational vehicle. The use of this equip-

ment inside the recreational vehicle may cause fires or asphyxiation.

WARNING

Do not bring or store LP gas containers, gasoline, or other flammable liquids inside the vehicle because a fire or explosion may result.

A warning label has been located near the LP gas container. This label reads: DO NOT FILL CONTAINER(S) TO MORE THAN 80 PERCENT OF CAPACITY.

Overfilling the LP gas container can result in uncontrolled gas flow which can cause fire or explosion. A properly filled container will contain approximately 80 percent of its volume as liquid LP gas.

The following label has been placed in the vehicle near the range area:

IF YOU SMELL GAS:

1. Extinguish any open flames, pilot lights and all smoking materials.
2. Do not touch electrical switches.
3. Shut off the gas supply at the tank valve(s) or gas supply connection.
4. Open doors and other ventilating openings.
5. Leave the area until odor clears.
6. Have the gas system checked and leakage source corrected before using again.

LP gas regulators must always be installed with the diaphragm vent facing downward. Regulators that are not in compartments have been equipped with a protective cover. Make sure that regulator vent faces downward and the cover is kept in place to minimize vent blockage which could result in excessive gas pressure causing fire or explosion.

INTRODUCTION

Congratulations on the purchase of your new RV. We sincerely thank you for choosing our product. To help you enjoy your new RV, you'll find in this owner's manual many useful tips for camping trips as well as basic operation and maintenance information for your RV's systems and appliances.

TRY A SHORT TRIP FIRST. The experience you'll gain from this will help make your future RVing more enjoyable.

To complement the standard and optional equipment you've chosen for your unit, there are many other accessories available. You may wish to use your unit several times before you invest in these accessories. What may be a necessity for one RVer could prove to be of no value to you. Remember, your dealer is always ready to help and advise you.

We go into great detail in this manual and for good reason. If you are a first-timer, we want you to learn to operate your RV correctly, to be able to use its components, appliances and any optional equipment in the most efficient manner.

At first glance, you may be overwhelmed by all the detail. But after you've used your new RV a couple of times, you'll be able to perform all the checks, start-ups and systems in much less time than it takes to read our instructions.

If you're a veteran RVer, you know that things change and a quick review of this manual will bring you up to date on what's new.

So read on. Happy camping!

NOTE: Because of the variety of models we offer, your RV may not have all of the components illustrated or described in this owner's manual. Ask your dealer for details concerning the specifics of your unit.

LICENSES

Vehicle licensing laws vary from state-to-state. Check with your state license bureau or the nearest licensing branch office for the requirements of your state. Be sure to renew your driver's license if it has expired or will expire during your trip.

INSURANCE

Personal liability, property damage, collision and theft of contents may be features of your automobile insurance policy that apply to your RV. Talk to your insurance agent about the details of your coverage. Always carry your insurance policy and/or card with you when you travel.

TRAVEL PREPARATIONS

It's always a good idea to **plan** your trips. Make arrangements for someone to check your house

periodically while you're on your trip. Stop mail and newspaper delivery. If you intend to be away for more than two weeks, request police surveillance for your house. Carry an extra set of vehicle and house keys with you on a separate key ring.

Fill your fresh-water tank before leaving. When traveling in winter, however, don't fill the water tank until the interior of your unit is thoroughly warmed or until you reach your destination.

Decide on the various items of equipment, clothing, food and other supplies you'll need for the length and destination of your trip.

Each moment you spend loading your RV is time you lose from the length of your stay. To reduce loading time, stock your RV with a supply of plastic or paper dinnerware, stainless steel or plastic flatware, pots, pans, towels and bedding. Try to use paper, plastic and aluminum whenever possible. They are lighter and less likely to break when the vehicle is moving. If you are planning an extended trip, pack only enough food for two or three days; you can replenish your supply along the way. Don't try to take enough food for the whole trip. Plan meals so that fresh or refrigerated items are used before they spoil. Keep a basic supply of seasonings (sugar, salt, pepper and spices) in your RV. See APPENDIX B: TRAVEL PREPARATION CHECKLIST for more tips on what to pack for your trip.

GENERAL DRIVING CHECKS

For your safety, make certain that the following items have been checked and rechecked before you take your RV unit on the road. Be sure to read APPENDIX A: PRE-TRAVEL CHECK for additional driving checks.

HYDRAULIC LEVELERS — Must be raised as far as possible.

LIGHTS — The following lights should be tested: brake lights, warning lights, flashers, clearance lights, taillights and headlights.

REARVIEW MIRRORS — Adjust the rearview mirror so that the driver can see the right and left sides of the unit.

IMPORTANT DOCUMENTS

Always carry your vehicle registration, insurance policy card(s) and owner warranty registration card. If you are borrowing a vehicle, it is best to have with you a notarized letter of approval from the owner authorizing you to be in possession of the vehicle.

COURTESY

Common courtesy will help make your stay more pleasant. Campsites often are close together and loud noises may disturb neighboring campers. Follow the posted rules of the campsite. Open fires might not be permitted. If you are permitted to build a campfire, clear the area of all flammable materials; never

leave a campfire unattended, and always make certain the embers are completely extinguished before leaving the campfire or before going to sleep. Good RVers are proud of the fact that they always leave a campsite cleaner than they found it.

TOURIST INFORMATION

Obtain current road maps and tourist information for each state you'll visit or drive through. You also may want to purchase a tourist guide book.

If you will be visiting federally-operated national parks, monuments and recreation facilities, you might find the Golden Age Passport and/or the Golden Eagle Passport useful. These passports can help families cut expenses at areas where fees are involved.

GOLDEN AGE PASSPORT is a free lifetime pass for persons age 62 and over. It covers all admission fees and includes a 50 percent discount on usage fees (except fees charged by privately operated concessions). This passport is available only at park service offices and at parks where entrance fees are charged. It cannot be obtained through the mail or at post offices. To obtain the Golden Age Passport, you will need proof of age, such as a driver's license. (Medicare cards are **not** accepted as proof of age.) If you do not have adequate proof of your age, be prepared to sign an affidavit swearing that you are at least 62 years of age.

GOLDEN EAGLE PASSPORT is designed for persons who plan to visit in a single year several parks or federally-operated facilities. It covers all admission charges, but does not cover usage fees. It is good only during the calendar year in which it is issued. It may be purchased in person or through the mail from the National Park Service Headquarters, Department of the Interior, Washington, D.C. 20240; at regional National Park Service offices, or at similar facilities where entrance fees are charged.

Both Golden Age and Golden Eagle passports cover admission fees for passengers accompanying the permit holder. Where entry to the recreation facility is not by private vehicle, each passport covers only the permit holder and the permit holder's immediate family.

VISITING CANADA OR MEXICO

The information in this section is general and is subject to change by the Canadian or Mexican government. For specific information, including rules for re-entering the U.S., as well as points of interest and campsites, contact the consulate nearest the point at which you plan to enter the country.

Passports or visas are not required for entry into CANADA or MEXICO. You must, however, carry your birth certificate, voter's registration card, baptismal certificate or similar proof of identity when

entering one of these countries. Naturalized U.S. citizens should carry their naturalization papers or other proof of citizenship. Persons under 18 years of age should carry a notarized letter from their parents or guardians giving them permission to travel in CANADA or MEXICO.

No special driver's license or permit is necessary in either country; but, renew your license if it has expired, or will expire during the trip. Proof of vehicle ownership is required at the border. If you are using someone else's unit, you should have a notarized letter authorizing its use.

MEXICO

A tourist card is necessary for visiting in MEXICO if you will be staying more than 72 hours or travel more than 40 miles from the border. Cards can be obtained at the port of entry or from a Mexican consulate.

Vehicles

MEXICO requires a vehicle permit for every self-propelled vehicle. The permit can be obtained only from Mexican Auduana (customs) offices upon presentation of tourist card, vehicle registration and title or notarized statement from owner. Your insurance policy is **not** valid in MEXICO. Temporary insurance must be purchased from Mexican companies (usually offices are located near the border).

CB Radio

MEXICO currently prohibits the use of CB radios.

Hunting and Fishing

Hunting and fishing laws in MEXICO are extremely complicated. To request information, contact:
Secretaria de Comunicaciones
Estados Unidos Mexicanos
Mexico DF

Dogs and Cats

MEXICO requires a certificate signed by a licensed veterinarian. The certificate should describe the pet and show that the pet has been vaccinated for rabies within the past six months. A fee is charged for the required verification of the certificate by a Mexican consulate.

CANADA

Vehicles

CANADA requires a Canadian Non-Residential Interprovincial Motor Vehicle Liability Insurance card, which is available only from U.S. agents. All provinces in CANADA require evidence of financial responsibility if visitors are involved in an accident. Limits vary from province to province. Contact your insurance agent for details.

CB Radio

CB radio operation in CANADA requires a temporary license. To obtain such a license, write to:
Regional Director
Telecommunications Regulation Branch
Department of Communications
20th Floor
2085 Union Avenue
Montreal, Quebec H3A 2C3
Canada

Hunting and Fishing

Revolvers, pistols and fully-automatic firearms are prohibited in CANADA. Each province has its own laws and licensing requirements. You must provide a written description and the serial number of each gun at the border. A license must be obtained from the province in which you intend to hunt or fish. Further information can be obtained by writing to the Department of Lands and Forests, Wildlife Branch, in the province you intend to visit.

Dogs and Cats

CANADA requires a certificate signed by a licensed veterinarian in the U.S. or CANADA stating that your dog has been vaccinated for rabies within the past 12 months. The certificate must contain a description of the dog and date of vaccination. Puppies under three months old need no certificate. There is no restriction on the entry of healthy cats.

LOADING

A properly loaded vehicle is safe and easy to drive. Distribute your cargo evenly from side-to-side and from front-to-back.

Heavier items should be stored as centrally as possible, on or near the floor. They should be secured so that they cannot slide during a sudden stop and cause damage. (Loose cargo can alter the balance you had when you started.) Lighter items can be stored in overhead cabinets or other areas. Remember to leave space and weight allowance for souvenirs and other items you may purchase during your travels. A properly loaded unit can help conserve fuel and can prevent excessive wear on your vehicle's automotive system.

WEIGHT DETERMINATIONS

If you plan to carry more than several hundred pounds of cargo in your RV, it is extremely important that you weigh your unit **before** you leave on a trip. Check the Gross Axle Weight Rating (GAWR) and the Gross Vehicle Weight Rating (GVWR) found on the Federal Sticker affixed to each vehicle. The Federal Sticker or certificate lists the unit Serial Number and the front and rear GAWR and GVWR.

It is located on the left outside front corner of your RV. The rating listed on the sticker is for the specific wheel and tire sizes listed.

MFD. BY (RV MFG. NAME)
THIS CAMPER CONFORMS TO ALL APPLICABLE FEDERAL MOTOR VEHICLE SAFETY STANDARDS IN EFFECT ON THE DATE OF MANUFACTURE SHOWN ABOVE.
CAMPER WEIGHT IS _____ LBS.
MAXIMUM WHEN IT CONTAINS STANDARD EQUIPMENT, _____ GAL. OF WATER, _____ LBS. OF LIQUEFIED GAS, AND _____ CUBIC FT. REFRIGERATOR (OR ICE BOX WITH _____ LBS. OF ICE, AS APPLICABLE). CONSULT OWNER'S MANUAL (OR DATA SHEET AS APPLICABLE) FOR WEIGHTS OF ADDITIONAL OR OPTIONAL EQUIPMENT.

FEDERAL STICKER

We suggest that you record this sticker information in the space provided here to ensure that you always have the information close at hand.

GVWR _____ GAWR Front _____

GAWR Rear _____ with _____ tires

RIMS _____ at _____ PSI cold _____

You can weigh your vehicle at a grain elevator, sand and gravel dealer or government weighing station. Make an appointment to weigh your unit fully loaded. There may be a small fee for weighing your vehicle; however, it is an investment in safe traveling and peace of mind. Check your Yellow Pages for the address and telephone number of the weighing facility nearest you.

NOTE: Exceeding the GVW and GAW specifications for your unit could result in serious damage to the suspension, frame or other components of your vehicle. Use of heavier suspension components (springs, shocks, axles) or heavier-ply tires does not increase the weight ratings printed on the tow vehicle's Certification plate. The GAWR of each axle is determined by the axle system components with the lowest weight-carrying capacity. To avoid overloading your vehicle, check the GVWR and GAWR.

DEFINITIONS

GAWR — The allowable weight, including cargo, which can be safely supported by each axle.

GVWR — The maximum permissible weight of your unit, all options, passengers and cargo.

GVW and GAW — These are found by weighing the vehicle fully loaded. GVW is the actual weight of the unit and all standard and optional equipment, cargo and passengers. GAW is the portion of the fully-loaded vehicle which is transferred to each axle.

AIR CYLINDER SUSPENSION

Some models are equipped with front and/or rear air cylinder suspensions. Air pressure in these cylinders may be increased or decreased to adjust vehicle trim and minimize "bottoming out" on large road bumps. Inflation pressure should be checked at least monthly.

If your unit is so equipped, inflation pressure must be maintained between 10 psi minimum and 50 psi maximum on 4,300-pound front suspension and 40 psi minimum and 50 psi maximum on 5,000 front suspension. On rear suspension, minimum is 40 psi and maximum is 80 psi.

To determine what kind, if any, air suspension system is on your unit, consult your dealer.

TAG AXLE SUSPENSION

Some larger motorhomes are equipped with tag axle air suspension systems. These systems should be checked and serviced by your dealer after the first 500 miles and regularly thereafter.

Refer to your component Owner Service Manual for detailed servicing instructions.

TOWING

If your Class A or Class C (chopped van) motorhome is equipped with an optional hitch towing package, do not exceed the Gross Combined Weight Rating (GCWR) as stated in the chassis manufacturer's owner's manual. If you add an optional hitch towing package refer to the hitch manufacturer's manual for complete instructions.

VEHICLE WEIGHING

STEP 1 — Drive only the front axle of the unit onto the scale. Compare the weight to the front GAWR listed on the Federal Sticker.

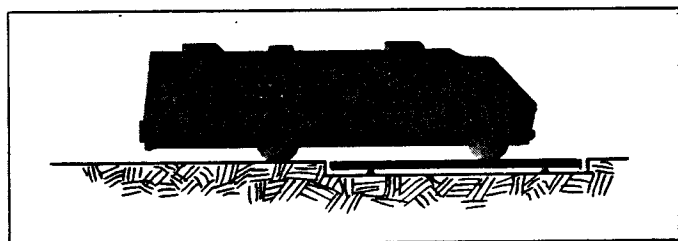

FRONT GROSS AXLE WEIGHT

STEP 2 — Pull forward so that the front and rear axle(s) are on the scale. Compare the weight to the GVWR listed on the Federal Sticker.

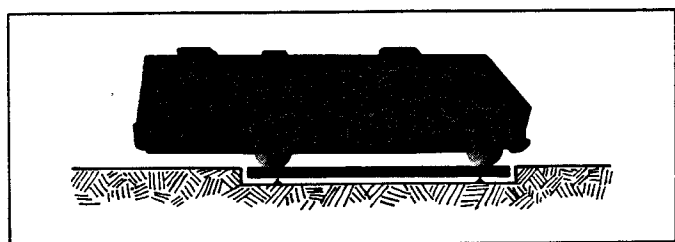

GROSS VEHICLE WEIGHT

STEP 3 — Pull forward so that only the rear axle(s) is on the scale. Compare the weight to the rear GAWR listed on the Federal Sticker.

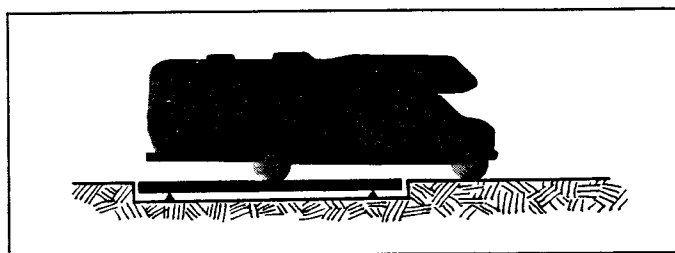

REAR GROSS AXLE WEIGHT

NOTE: If any of the weights exceed the listed rating, relocate the passengers and redistribute or remove a portion of the cargo until the weight is within the proper tolerance.

DRIVING

Get to know how your vehicle handles. Power steering and power brakes help make driving your motorhome as effortless as possible, but you must remember it is longer, higher, wider and heavier than a family automobile.

Before leaving on a trip, practice making right and left turns, braking, backing and accelerating. Your RV is designed to travel at maximum legal highway speeds under ideal conditions. Under less than ideal conditions, your vehicle should be operated at reduced speed and it should never exceed the posted legal speed limits. Before you travel be sure to read APPENDIX A: PRE-TRAVEL CHECK in this manual. Below are tips to help you.

CLEARANCE

Be sure to read "Clearance Height" signs on overpasses, drive-through windows, etc. Watch out for overhanging tree branches, awnings or similar obstructions that can damage your vehicle's roof or roof-mounted equipment and accessories. Check with your dealer for clearance measurements of the unit.

PULLING INTO TRAFFIC

Check for oncoming traffic in all directions. Signal before entering the flow of traffic. Always accelerate slowly and smoothly; the weight of your RV makes quick acceleration not only difficult but potentially unsafe.

PASSING

Avoid sudden maneuvers when passing a slower-moving vehicle. Remember that additional time and distance are required to pass safely. Wait until the road is clear of oncoming traffic for at least 1/2 mile. Check the outside rearview mirrors and signal lane changes before passing other vehicles. When you

have safe clearance, signal lane change and return to your original lane.

BRAKING

Allow a safe distance to stop; follow no closer than one vehicle length for each 10 mph. Pump the brake pedal lightly to stop on wet or icy roads. If you start to slide, turn the wheel in the direction of the slide. Do not "slam on" the brakes; a sudden stop may increase the slide and could cause your unit to jackknife.

SWAYING OR FISHTAILING

If this happens while you are towing a vehicle, accelerate slightly and then gradually slow down. If your unit still sways, pull off the road and check the following:

1. Height of equalizer hitch,
2. Distribution of cargo,
3. Tire pressure, and
4. Motorhome front-end alignment and suspension.

TURNING

Pull several feet farther ahead before turning. This will compensate for the extra width and length of your RV and will help you avoid hitting curbs or parked vehicles.

BACKING

Remember that your motorhome is higher, wider and longer than other vehicles you may own, so it is extremely important that you back the RV slowly. Because visibility is somewhat restricted, backing the unit may require stationing someone beside the unit to guide the driver.

DOWNGRADES

When you are going downhill, reduce your speed and shift the transmission to a lower gear to assist in braking on long or steep downgrades.

UPGRADES

To avoid engine overheating when climbing a steep grade, reduce speed and shift the transmission to a lower gear.

OVERHEATING

If your motorhome's engine overheats, pull well off the road. Shift to Park (P) and run the engine with your foot resting lightly on the accelerator pedal. If the engine does not cool within 2 to 3 minutes, turn it off and locate the problem.

Engine temperature problems may be avoided if you climb long grades and descend moderately steep grades in second gear; climb steep grades in first gear and if your unit has auto air conditioning, turn it off.

CAUTION

DO NOT exceed the maximum speed listed in the chassis manufacturer's manual for first and second gear — excessive engine speed will overheat the transmission, which may cause early transmission failure.

PARKING ON A GRADE

Parking vehicles on an upgrade or downgrade is not recommended. If it is necessary in an emergency, always apply the foot brake, then set the parking brake before moving the shift lever to Park (P). When preparing to move the vehicle, move shift lever out of Park before releasing the parking brake. If this sequence is not followed, you may not be able to move the shift lever out of Park. If this torque lock does occur, you may need to have another vehicle assist you in relieving the pressure on the shift lever. On severe grades it may be necessary to have a passenger place wheel chocks behind the tires of your RV.

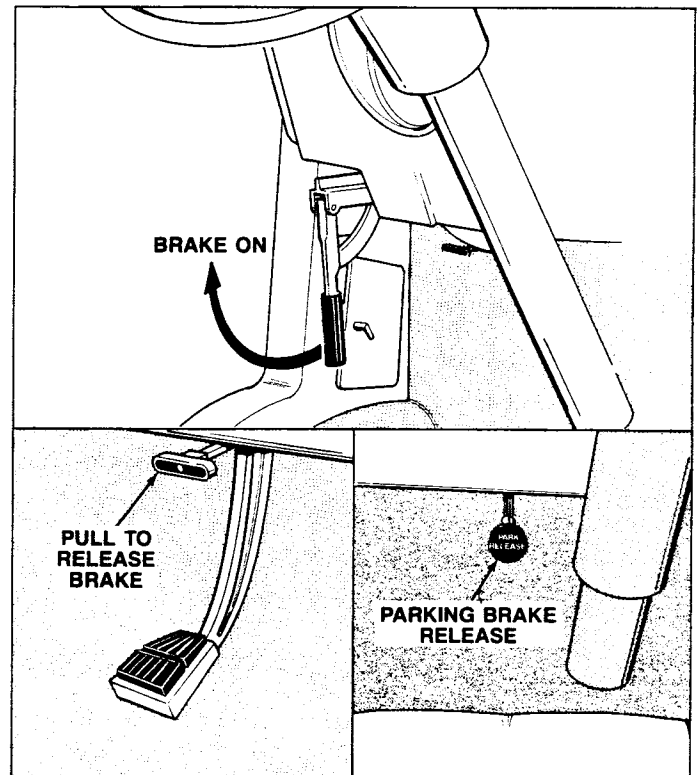

PARKING BRAKES TYPICAL

NOTE: If your Class A motorhome is built on a chassis manufactured by John Deere, the emergency brake is automatically engaged when the shift lever is moved to the Park position.

For manual transmission vehicles, place the shift lever in low gear.

HOLDING ON AN UPGRADE

Use the foot brake or parking brake and Park (P) position to hold the vehicle on an upgrade. Using a

driving gear to hold the unit may cause the engine or transmission to overheat. **DO NOT** idle the engine for more than one minute with the transmission in gear.

FREEING A STUCK VEHICLE

To pull your vehicle out of the snow, sand or mud, apply slight pressure to the accelerator pedal and move the gear selector lever rhythmically between first gear and Reverse (R). If possible, keep the front wheels pointed straight ahead. Avoid sharp turns. Once the unit starts to move, do not stop until it is on firm ground.

CAUTION

DO NOT race the engine or spin the wheels; prolonged efforts to free a stuck vehicle may result in overheating and transmission and axle failure.

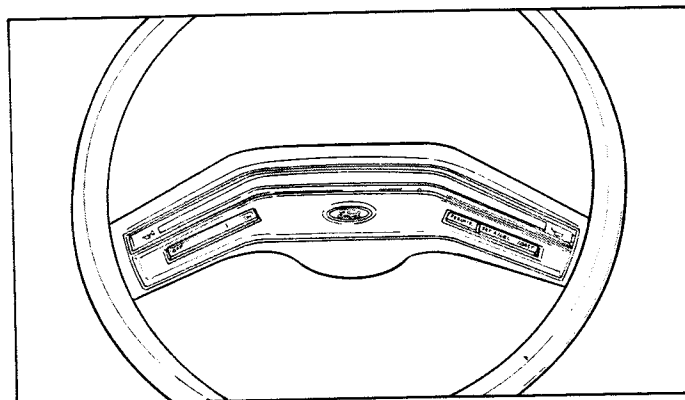

FORD CRUISE CONTROL

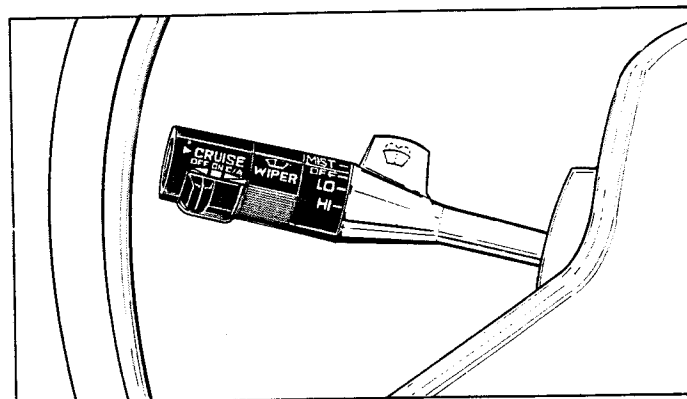

CHEVROLET CRUISE CONTROL

TIRE CHANGE

Change a tire on as level and firm a surface as possible. If you are on the roadside, activate the vehicle's hazard warning flashers. Apply parking brake and move transmission selector to Park (P). Set up flares and/or warning lights. See the chassis manufacturer's owner's manual for specific jacking and tire removal and replacement instructions which pertain to your unit. Stop at the nearest service facility and have the torque checked.

CAUTION

Never place the jack under a bumper or edge of the sidewall. On units equipped with a tag axle, never place the jack under the tag axle. Use the jack only for changing tires. Never get underneath the vehicle when using the jack; never start or run the engine while vehicle is on the jack. Always securely stow the spare tire on the spare tire carrier and return all jacking equipment to its proper storage area.

SPEED CONTROLS

Your unit may be equipped with a cruise control device, which automatically controls speeds at over 30 mph. The type of speed control depends upon whether it is original chassis equipment and will vary with the chassis type and chassis model year. Also, there are several types of speed controls which may be installed by the RV manufacturer.

The speed controls may be on the turn signal lever or on the spokes of the steering wheel. Despite the varying locations, the basic operation of each is similar. However, certain speed control devices have specific differences, so it is important that you very carefully read the instructions in the chassis manufacturer's owner's guide or those furnished by the manufacturer of the speed control device.

CAUTION

Do not use any auto speed control when conditions are not suitable for maintaining a constant speed, such as in heavy or varying traffic, in strong winds, on extreme grades, or on slippery, winding or unpaved roads. Never shift to Neutral (N) when using the speed control; it will cause the engine to over-speed. Use only properly installed, FCC-approved radio transmitting equipment (such as CB radios). Use of other transmitting equipment may cause the vehicle to malfunction.

DASH INSTRUMENT CONTROLS

Your motorhome automotive instruments and controls are designed for convenience and safety. Since dashboards will vary depending on model and options chosen, read the chassis manufacturer's owner's manual for complete details on operation and maintenance of the systems. The illustrations below are for reference only. Your RV dealer will be happy to acquaint you with the controls in your unit.

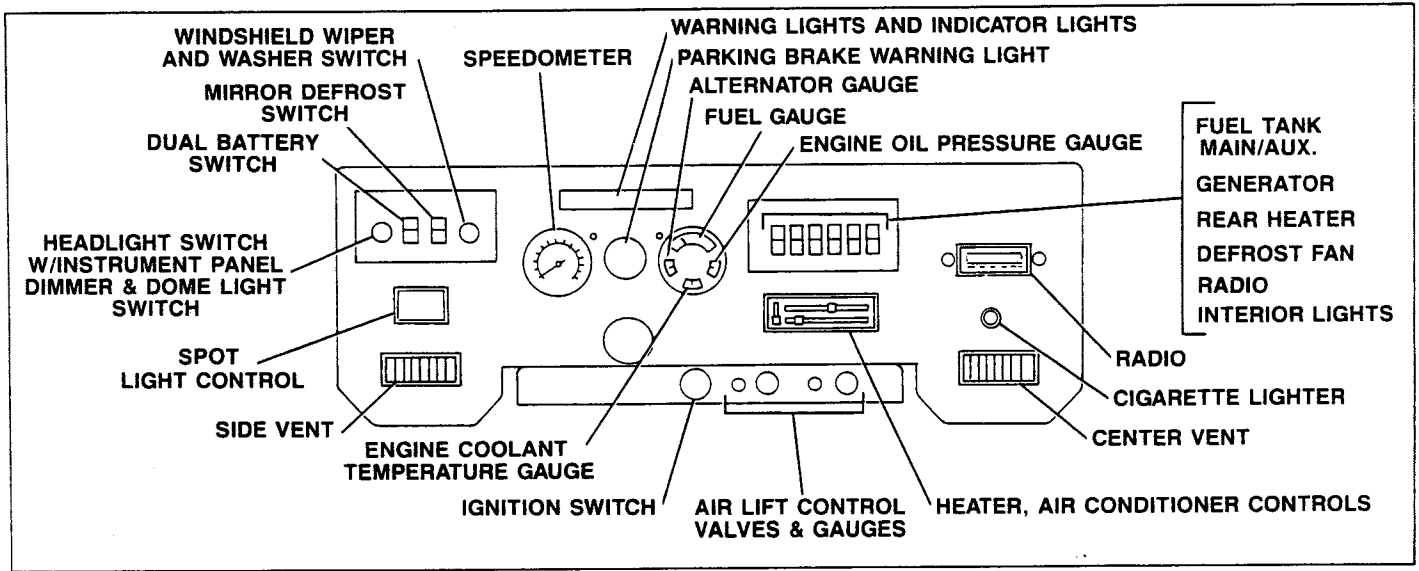

CLASS A DASHBOARD — TYPICAL

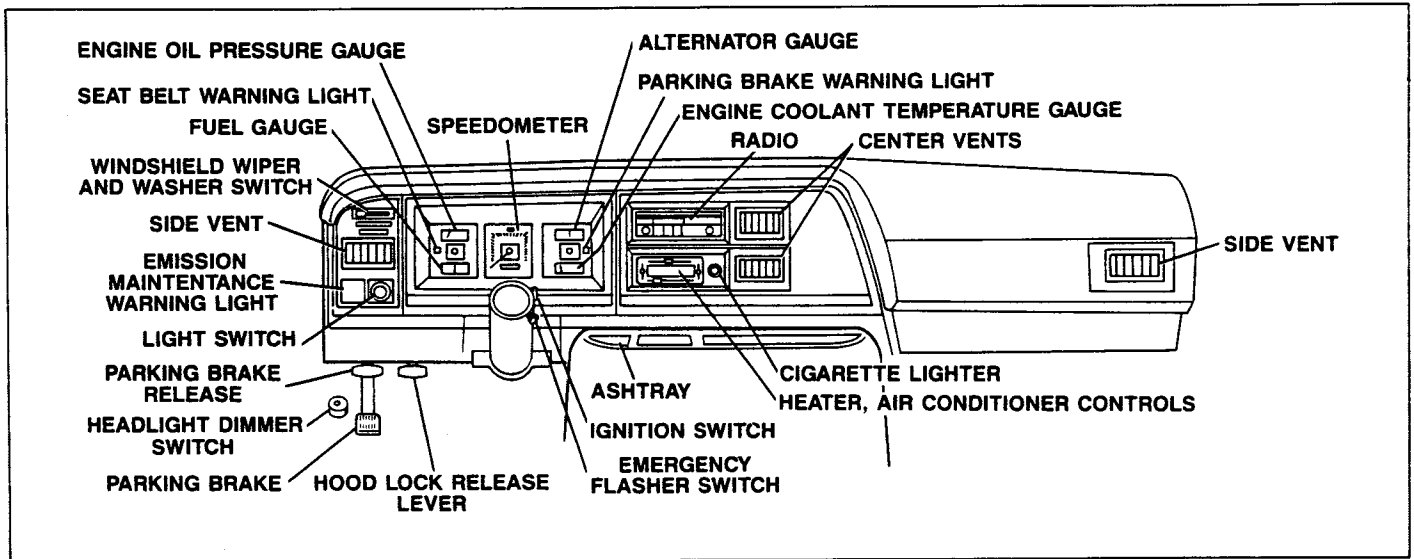

CLASS C DASHBOARD — TYPICAL

TILT STEERING WHEEL

If your unit is equipped with a tilt steering wheel, it can be moved to allow additional room for entrance and exit, as well as selected driving positions.

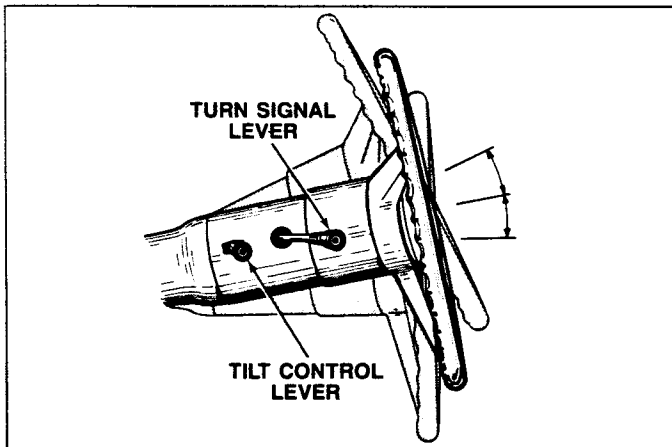

TILT STEERING WHEEL — TYPICAL

Operate the tilt mechanism by lifting the small control lever on the left side of the steering column just below the directional signal lever (some models have the tilt steering lever incorporated into the signal lever). Move the steering wheel to the desired position and release the lever to secure in place. Do not adjust steering position while the vehicle is in motion.

CAMPING

CAMPSITE SELECTION

There are many campground guides that will assist you in making your selection. Many campgrounds accept reservations, and during peak seasons, it is wise to make a reservation. If possible, arrive early so you can inspect and choose your campsite during the daylight hours.

During the winter months it is desirable to take advantage of natural windbreaks like trees, bushes

or any similar type of windbreak. This will cut down the possibility of cold drafts that can affect the comfort level of your unit.

SET-UP

It is very important that your unit is level. This allows your refrigerator and drainage systems to operate properly (both function by gravity). To determine levelness, place a level on the bottom of the refrigerator's freezer compartment or in a normally level location inside the vehicle. You may wish to permanently attach levels (available at your dealer) on the front and/or back and sides of the RV. This will allow you to tell at a glance if you've stopped on a level site and will help speed the leveling process.

LEVELING

If the unit needs side-to-side leveling, make a step leveling ramp on the low side out of 1 x 6" or 2 x 6" boards of varying lengths. Pull the unit forward or back onto the leveling ramp until the tire(s) on the low side is level. Many experienced RVers carry level boards or blocks in their unit for this purpose.

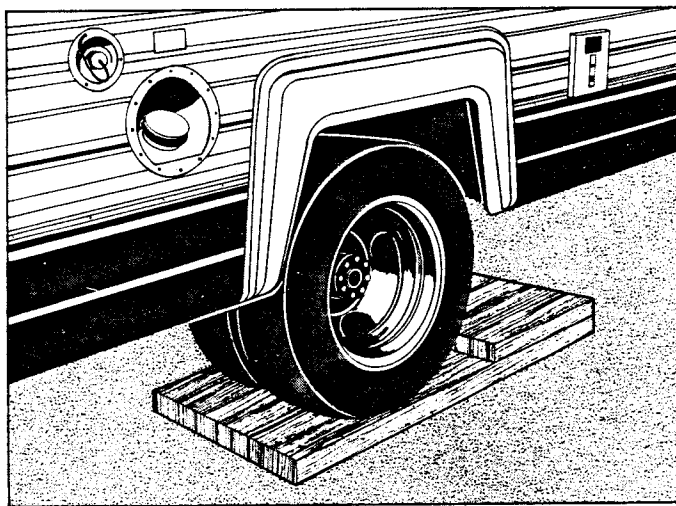

STEP LEVELING RAMP

LIVING AREA

AIR QUALITY

State-of-the-art construction and energy-conservation methods have been used in manufacturing your RV. These improvements have substantially reduced air infiltration and air exchange, making them almost airtight. Therefore, periodic airing of your unit is recommended on a regular basis, especially during periods of high temperature and high humidity, and after prolonged storage.

CONDENSATION

Condensation can be a problem in modern, tightly-constructed, well-insulated RVs. Certain amounts of condensation should be expected,

especially on cool surfaces such as windows, roof vents, and metal door frames. However, when there is excessive condensation — the troublesome kind that blocks all windows with fog or frost — damage to walls, woodwork and ceilings can occur.

Remember that sweating windows are a signal indicating that moisture is trying to get out to mix with drier air.

CONTROLLING CONDENSATION

When the unit is closed tightly, especially in cold weather, the small air volume in your RV can absorb only a certain amount of moisture. Bathing, dish washing, laundry appliances and unvented gas burners are among the causes of added moisture in the air — all pouring more water vapor into your RV. You can control the amount of moisture in the air by allowing the moisture to escape to the outside. Use your vent hood and fan when you cook; keep bathroom door closed and the vent or window open while you bathe or shower (and for a short time after you have finished bathing or showering, to allow all the moisture to dissipate); don't hang wet clothes in your unit; and if you have a clothes dryer, be certain it is vented to the outside.

NOTE: Condensation can cause your RV's insulation to become damp, reducing its insulating properties.

TABLES

Listed below are general instructions for setting up the variety of tables and beds found in RVs. Your dealer will be happy to demonstrate these items in your unit.

LOUNGE SWING UP TABLE: To raise, pull up table until it latches. To lower, release center folding joint.

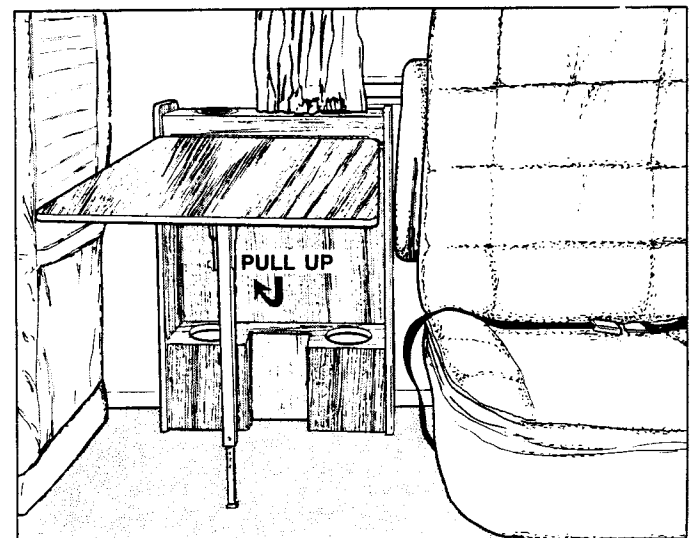

LOUNGE SWING UP TABLE

SWING UP TABLE: To raise the swing up table, pull the table toward you and up; then push it toward the wall. Insert brackets at back of table into the wall supports. Pull the leg down and adjust to the proper height.

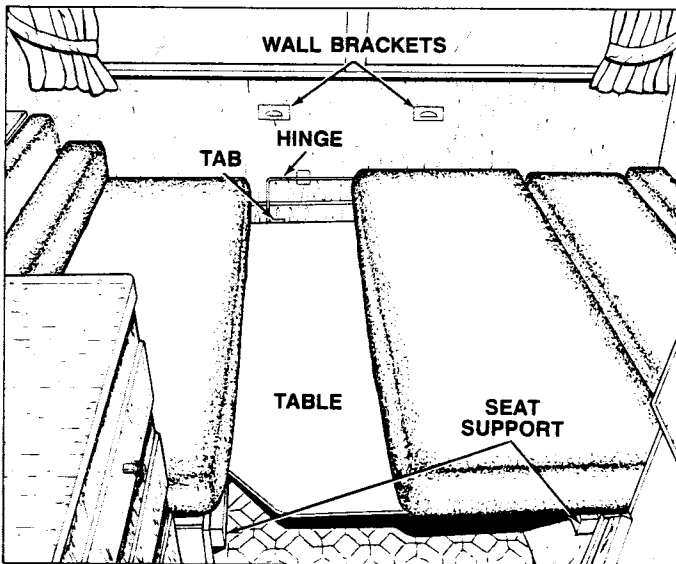

SWING UP TABLE

PULL-UP TABLE: Lift pull-up table from its storage location behind the cabinet. Lay it in position across the top of the cabinet. Some pull-up tables have extension leaves.

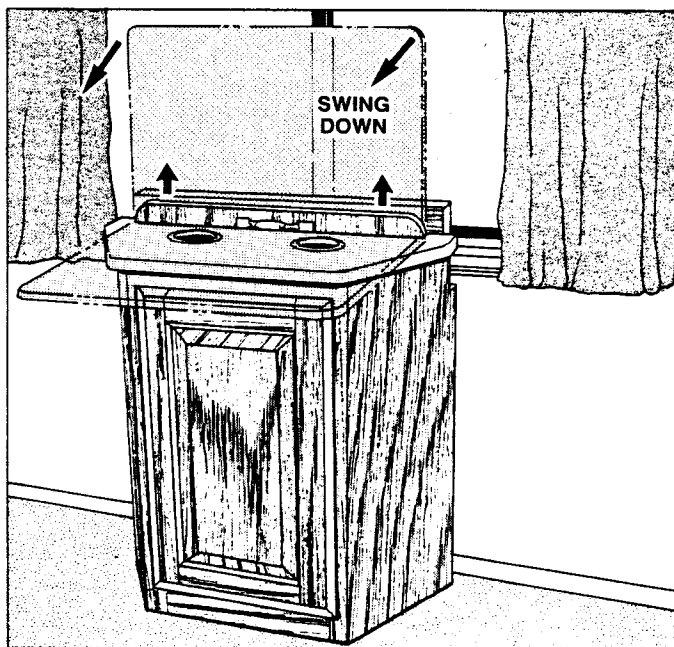

PULL-UP TABLE

PEDESTAL TABLE: Insert table leg into base plate. Lower table support bracket onto the leg.

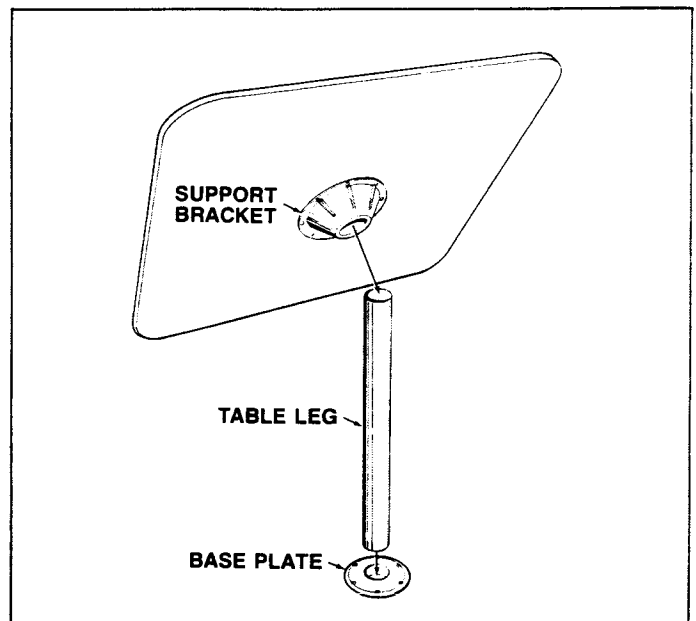

PEDESTAL TABLE

EXTERIOR PICNIC TABLE: An exterior pull-out picnic table (Figure 1, Page 43) is optional equipment on all MB/BH (Basement) models. To use, release the lock mechanism on the right side of the table support and slide table out. Also located in the same compartment is an exterior TV connection (Figure 1, Page 43).

BEDS

GAUCHO: Lift the front edge of the lounge platform and slide it out. Arrange cushions on the platform.

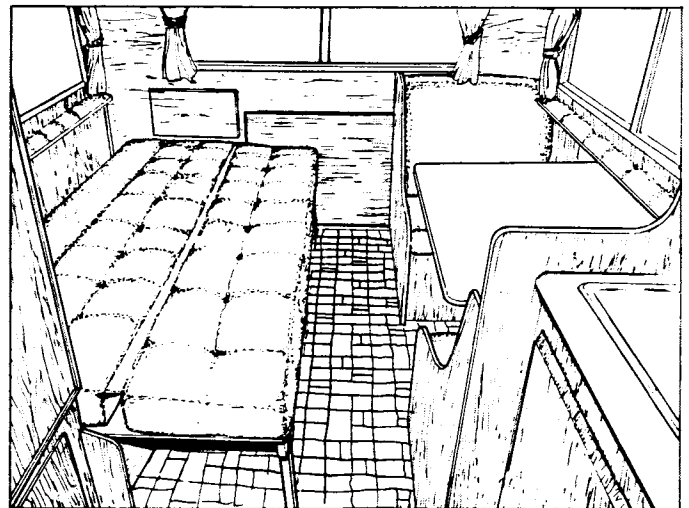

GAUCHO BED

OVERHEAD BED: The front overhead bed (Class A motorhomes) and rear overhead bed (Class C motorhomes) have gas piston supports. Simply pull down on the front edge until it is completely lowered. When not in use, push up to the travel position. Some overhead beds may have support straps of vinyl or Velcro which must be unfastened before bed is pulled

down. The straps should be reattached when the bed is in the travel position.

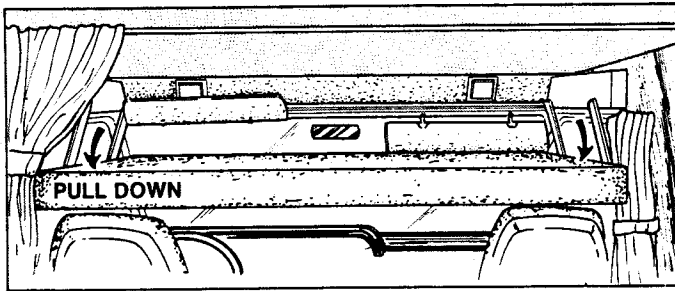

CABOVER BUNK — CLASS 'A' MOTORHOME

CABOVER: The cabover bed assembly (mini motorhomes and micro mini motorhomes) includes a privacy drape which slides along a track on the ceiling. To use the bed, place the cutout section on the supports. A driving area privacy drape can be attached by pressing the Velcro strip on the drape to the Velcro buttons on the inside of the bumper pad. The drape separates the driving area from the living area.

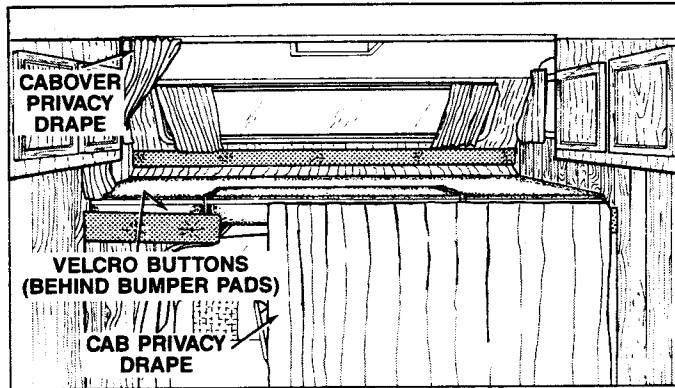

CABOVER BUNK — MINI MOTORHOME

DINETTE BED: For those with swing tables, move the leg to the UP position and pivot the table down to the dinette seat supports. Place the table on the seat braces and arrange the cushions on the top.

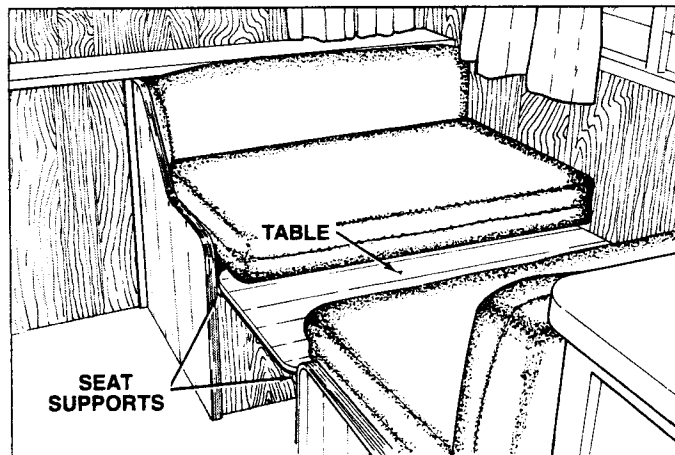

DINETTE BED

U-SHAPE BED: The U-shape dinette converts into a large bed. Remove the pedestal table, place it on the seat supports and arrange cushions on top. Some U-shape dinettes have a slideout base instead of using the table for the bed support.

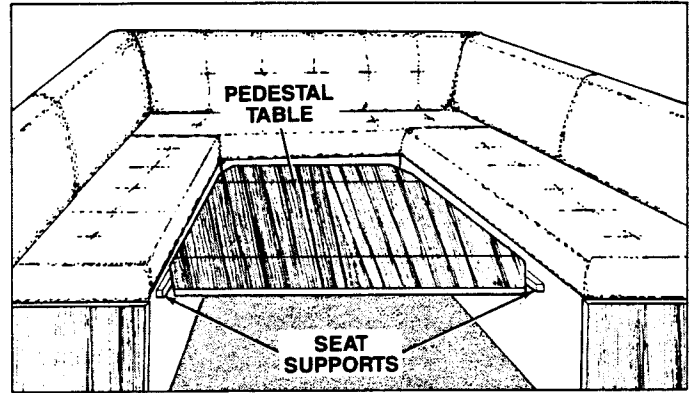

U-SHAPE DINETTE/BED

SOFA: Several types of sofas are used. Talk to your dealer for proper instructions for the sofa in your particular unit.

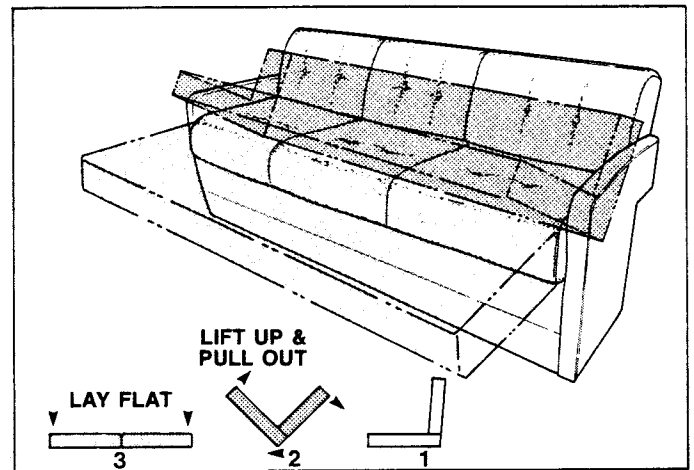

JACKKNIFE SOFA

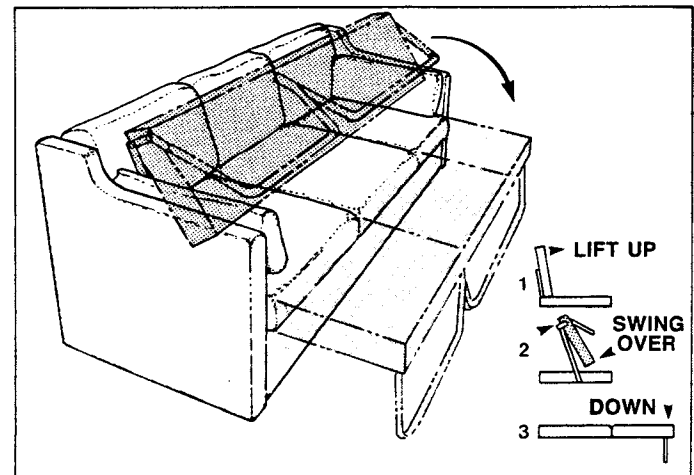

ROLL-OVER SOFA

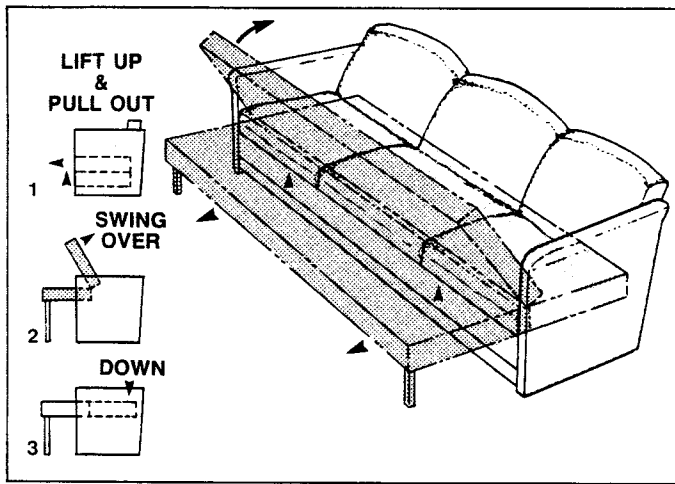

SUPER SOFA

DRIVER AND PASSENGER CHAIRS

Some driver and passenger chairs slide, swivel and recline; others may slide and swivel or slide only. Some operate mechanically and some operate electrically. Have your dealer demonstrate the operation of the chairs in your unit. The captain's chair illustrated slides forward and backward, swivels and reclines in many positions.

To move the seat forward or rearward, pull lever located under the front left side to the left, then slide the seat in desired direction. To swivel the seat, push back on the lever under the seat on the right side and turn to desired position. The chair reclines in infinite positions by turning the crank knob clockwise or counterclockwise. Swing armrests up or down as desired.

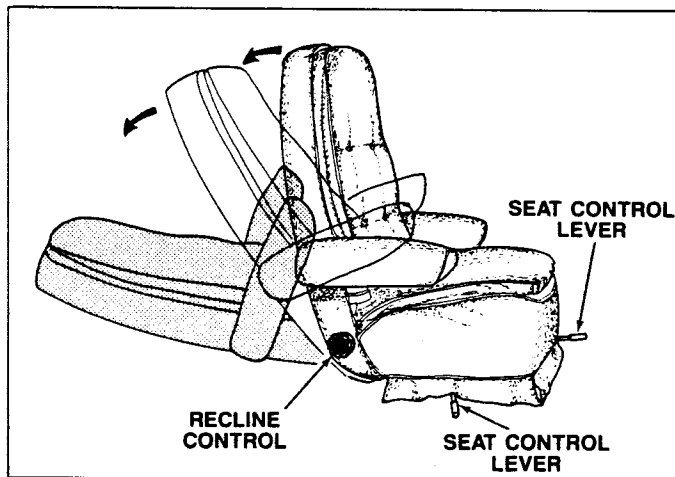

CAPTAIN'S CHAIR

REMOTE SWIVEL AND SLIDE CHAIRS — This mechanically operated chair features the controls conveniently located in the armrests. To slide the seat forward or back, release the button on the left armrest. To swivel the seat, release the button on the right armrest. The lever on the right side of the seat will cause the back of the chair to raise or recline.

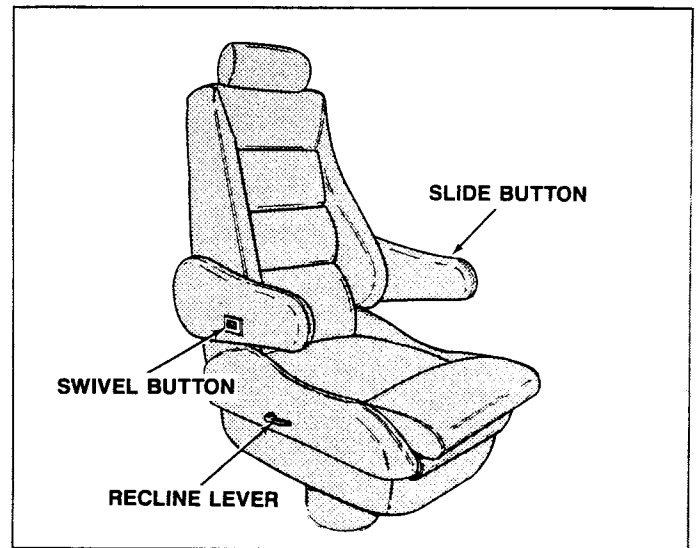

REMOTE SWIVEL AND SLIDE CHAIR

ELECTRIC PILOT SEAT OPERATION: The switch assembly is mounted on the side of the pilot seat next to the engine motor cover. The seat has three control levers. The forward lever controls the angle of the front of the seat, the rear flat lever controls the angle of the rear of the seat (push switch up to tilt angle upward and push switch down to tilt angle downward), and the round lever located between the two flat levers controls the forward/backward slide (push the lever forward to move seat forward and push the lever back to move the seat backward).

NOTE: Seat must be occupied before operating any of the controls to prevent damage to the mechanism.

The chrome lever on the side releases the lock so the back of the seat may be reclined.

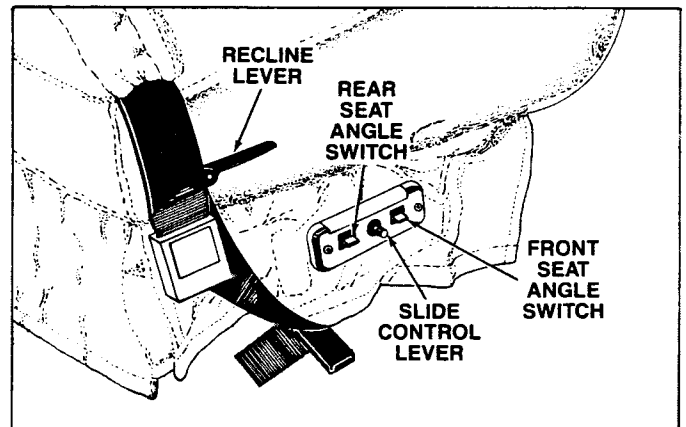

ELECTRIC PILOT SEAT

BARREL CHAIRS: To swivel mechanically operated barrel chair, push down on the lever located on the right side of seat and turn seat to desired position. To slide the seat, pull lever located at left front and move seat forward or backward. Some units are equipped with electrically operated barrel chairs with controls on the arm.

DIVIDER DRAPES

A divider drape, to separate the driving area or bath from the living area, is installed in some models. The drape slides along a ceiling track. When open, it can be attached to the unit's side, behind the driver or at the door frame with a tieback.

The optional windshield drapes are designed to provide privacy when parked and slide along a track over the sun visors. The drapes meet in the center of the windshield when closed. Secure with tiebacks on either side of the unit when open.

A folding divider door, installed in some models, slides along a track at the top of the doorway or ceiling. Secure open with tieback when not in use.

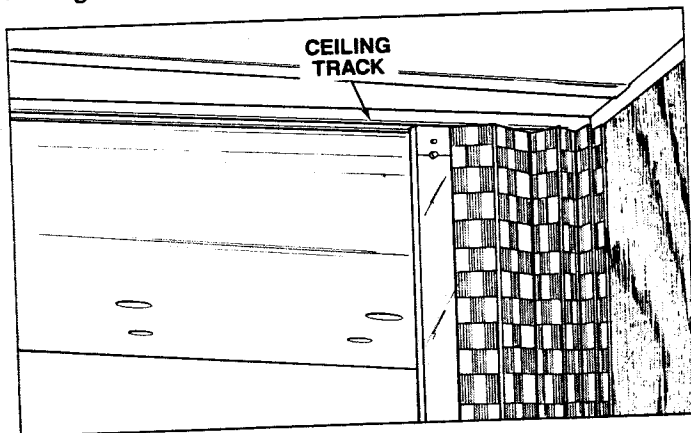

FOLDING DOOR

BASIC UTILITY SYSTEMS

This section will describe the four basic utility systems found in your RV. They are: Electrical, Fresh Water, Drainage/Sewer and LP Gas. The following will familiarize you with their function, operation and simple maintenance. If a problem should develop with any of the four systems, notify your dealer or any authorized RV dealer for service.

MONITOR PANEL

Some units are equipped with a monitor panel that allows you to check the condition of your RV battery and the volume of fresh, waste and gray water in your unit's holding tanks. The monitor panel also may include a clock, water pump switch and a generator switch. The monitor panel illustrated is typical; the one in your unit may look and function differently. Your dealer will be happy to explain the operation of your monitor panel.

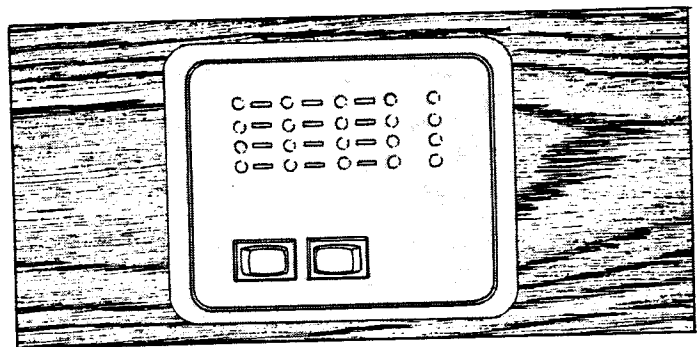

MONITOR PANEL — TYPICAL

ELECTRICAL SYSTEM

Your motorhome contains two separate electrical systems: one 12-volt direct current (DC) and one 120-volt alternating current (AC), similar to the one in homes. These systems provide you with power while you are camped or are traveling. The 120-volt system requires an external source of 120-volt electricity, usually a campsite or household receptacle or an auxiliary generator. The 12-volt electrical system is supplied by batteries, the power converter or the 12-volt source from the automotive chassis.

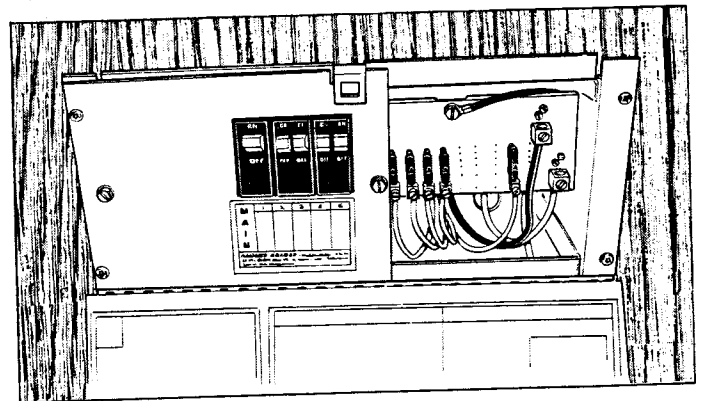

COMBINED POWER CENTER/CONVERTER

To reduce the 12-volt load on your RV battery, the 120-volt system should be used whenever a 120-volt hook-up is available. Although most components in your unit (water pump, range hood light and fan, interior lights) operate only from a 12-volt source, the power converter changes 120-volt AC to 12-volt DC power.

Dash Fuse Panel

The location of the dash fuse panel varies from model to model, however it is always located in the driver compartment.

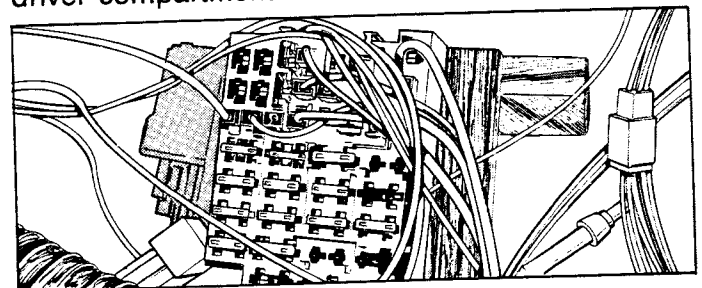

DASH FUSE PANEL

120-Volt System

The 120-volt system supplies power for the following through the power converter: refrigerator, exterior receptacles (Figure 2, Page 43), interior receptacles (used to operate regular household appliances), and optional roof air conditioner. The converter provides 12-volt power for all of the unit's 12-volt components. When the external 120-volt power cord is used, the power is connected directly into the main electrical service panel of the power converter and is distributed through circuit breakers.

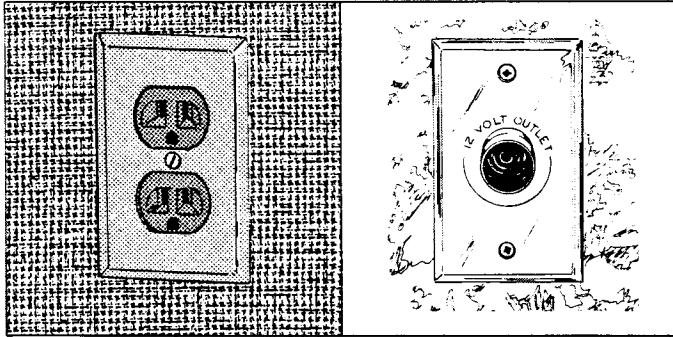

120-VOLT AND 12-VOLT RECEPTACLES

Ground Fault Interrupter/Receptacle

The bath and exterior receptacles are protected by a ground fault interrupter (GFI). The GFI is a highly sensitive circuit breaker, built into the bath receptacle, and connected to the outside receptacle. It protects against severe electrical shock if a ground fault occurs in that circuit. The GFI senses the fault and breaks the bath and exterior receptacle circuits. If this should happen, unplug all appliances on that circuit and reset the breaker in the bath receptacle.

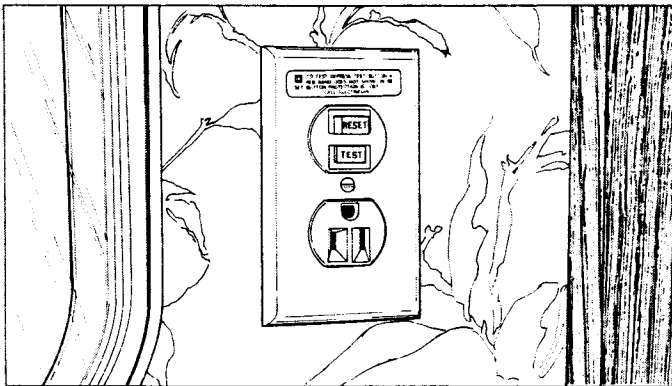

GFI RECEPTACLE

The GFI system should be tested at least once a month. To test the GFI system, plug a test light into the outlet and push the TEST button on the receptacle. The test light should go out. To restore power, push the RESET button. If the button does NOT pop out or if the test light indicates a live circuit, DO NOT use the outlets. Contact your dealer.

Shoreline Connection

The Shoreline (Figure 3, Page 43) is a heavy-duty

cable with a 3-prong grounding plug on one end, permanently attached at the other end, and connected to the power converter. It can be pulled from its storage compartment through a hatch in the sidewall of your vehicle and connected to an external receptacle. Some campsites and trailer parks still have two-slot outlets. If it is necessary to use a 3-to-2 adapter, be certain its grounding wire is fastened securely to the outlet grounding screw.

The 120-volt system is protected by the circuit breakers. If a circuit breaker opens, unplug the appliance(s) on that circuit, allow a short period for the breaker to cool, and reset the breaker. If the breaker continues to open, notify your dealer.

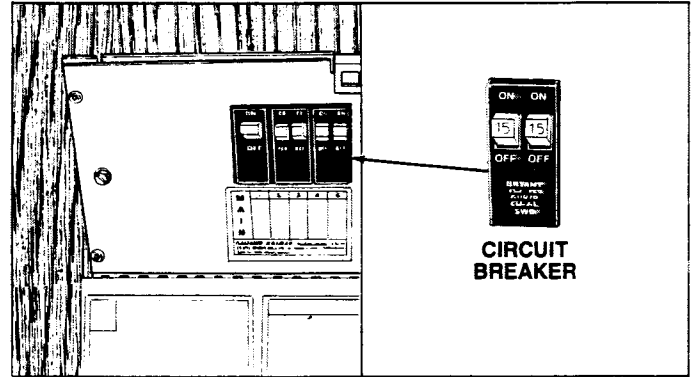

CIRCUIT BREAKERS

Generator

The optional auxiliary generator, (Figure 4, Page 41), is a gasoline-operated component that will supply 120-volt electricity. It can be operated when your vehicle is stopped or while you are traveling. It draws its fuel from a gasoline tank; on some models the generator has a separate fuel tank. A labeled remote generator starter switch is provided inside your unit. There is also a START/STOP switch mounted on the generator. An automatic transfer switch incorporated in the power converter prevents the simultaneous use of the generator and the Shoreline connection.

When the generator is started, the transfer automatically switches from Shoreline to generator power. When the generator is shut down, the transfer automatically switches to Shoreline power. Every time you start the engine, there is a 30- to 45-second delay.

NOTE: When running, the engine powering a generator can discharge carbon monoxide gas, particularly dangerous because it is colorless and odorless. When using a generator, do not open roof vents, windows or doors. These could draw fumes into your unit. Do not operate the generator where an object such as a tree, bush or building can deflect exhaust fumes to the inside of your unit. Do not operate the generator where exhaust gas could accumulate and seep inside an occupied vehicle, tent or building.

Start Up

Before starting your generator, make sure the air intake and exhaust outlets are free of obstruction. Check the oil level. Make sure all interior components are in the "Off" position. Depress the generator START/STOP switch to START until the generator is running (when released, the switch will return to the neutral position).

NOTE: When using the generator for the first time, apply the electrical load gradually to break in the engine. Operate the generator at 1/2 load for 30 minutes, then at 3/4 load for an additional 30 minutes before applying a full electrical load. The generator is warranted by its manufacturer.

Shut Down

To shut down the generator, press the START/STOP switch to STOP and hold it there until the generator stops running.

NOTE: Your generator is equipped with a Winter/Summer Carburetor Pre-Heat Switch which must be in the Winter position when outside temperature is 50 degrees or less.

Care of Generator

The complete operation and care procedures for your generator are in the generator manufacturer's manual.

12-Volt System

The 12-volt system, which includes the automotive battery and optional RV battery (Figure 5, Page 41), plus the 12-volt converter, supplies power to the exterior and interior lights, the range hood fan and light, the furnace blower, water pump, interior 12-volt receptacles, porch light and monitoring panel. The 12-volt receptacles can only be used for appliances specifically designed for that type of energy. The 12-volt energy is supplied by the automotive battery, the RV battery or the power converter.

The automotive alternator supplies 12-volt power to the vehicle's lights and components and the RV's 12-volt system, including running lights, brakes and appliances, when the engine is running. The automotive alternator also will charge the RV battery(s).

The RV battery supplies power to the furnace blower, monitoring panel, water pump, interior 12-volt receptacles, optional power vent(s), range hood fan and light and interior lights. The RV battery also is charged by the power converter whenever you are using a Shoreline connection.

To check the battery using the monitor panel, disconnect the Shoreline and turn on at least three interior lights. (A discharged battery will show full charge unless some electricity is being drawn.) With extremely heavy usage, water level should be checked daily.

Converter

The power converter section of the power center transforms 120-volt AC into 12-volt DC to supply power to all of the 12-volt systems. Each 12-volt circuit is protected by a fuse in the power center. Turn the twist lock to open the door and check the fuses. A listing of the circuits is on the inside of the door. Some fuses protect circuits with more than one function; others may be for specific appliances.

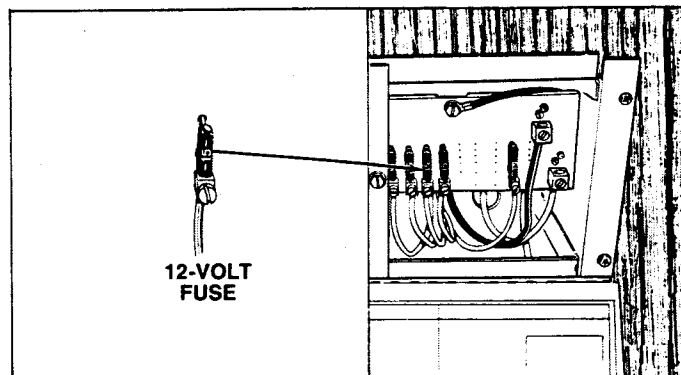

12-VOLT FUSE BLOCK

If a fuse is blown, turn off or unplug all appliances on that circuit. Replace the blown fuse with one of the same ampere rating. If the fuse continues to blow, notify your dealer. See the power center manufacturer's manual for specifications and operation and testing procedures.

FRESH WATER SYSTEM

Fresh water for your unit is supplied either by the vehicle's fresh water tank or by an external pressurized source (city water).

The water heater (either match light or electronic ignition) is an LP gas appliance that heats water to a preset temperature. To fill the water heater when your unit is connected to city water, simply turn on a hot water faucet. When water flows steadily, turn the faucet off.

City Water

When using the city water hookup, the water tank and pump are bypassed. You cannot fill the water tank through the city water inlet. Connect a hose to a "city pressurized" water faucet and to the vehicle's fresh water inlet (Figure 6, Page 43).

Although a common garden hose can be used to fill the water tank and connect to city water, long-time RVers recommend a hose specifically manufactured for this, available at your RV dealer.

NOTE: In areas where city water pressure exceeds 60 psi, you should use a pressure regulator, a standard feature on all Class A motorhomes, only. Excessive water pressure may damage lines and connections. See your authorized dealer for more details.

Water Tank

Because of a variance in weight distribution, the water tank may be beneath a gaucho, dinette, bed or kitchen cabinet or under the floor of the unit. To fill the water tank, open the gravity water fill by pulling out the fill spout (Figure 7, Page 43). Use a hose or vessel to fill the water tank. Water will flow out of the water fill when the tank is full.

The water tank should be sanitized before you use it for the first time, after a period of nonuse, and whenever you suspect the tank is contaminated. To sanitize your water tank, first empty the tank and then use the following procedures:

1. Mix 2½ cups of liquid household bleach with 10 gallons of water. Pour the solution into your tank through the gravity water fill.
2. Turn the water pump ON, open the hot water faucet, wait until the water begins to flow, and then turn the faucet off. Do the same with the cold water faucet. Wait three hours.
3. Open faucets and line drains. Drain the entire system. Some solution will remain in the water heater.

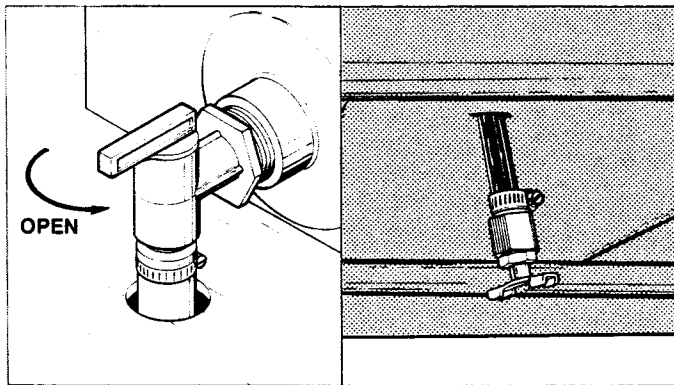

WATER TANK DRAINS

4. Insert a hose into the gravity water fill. Begin filling the tank. Open the hot water faucet. Be sure the water pump is on. Let the water run until the system is completely flushed. Do the same with the cold water faucet. The hot water faucet will need to run longer to completely drain the water heater.
5. If a chlorine taste lingers, flush the system with a vinegar and water solution (one quart of vinegar to five gallons of water). Wait two to three hours and then flush with fresh water.

Water Pump

The water pump is a 12-volt DC appliance that is activated by a switch on the monitor panel or a switch mounted in the kitchen area. (On some models a second switch may be located in the bathroom.) The switch can be left on while camping. When you want water, simply open a faucet. The pump, which supplies water from the fresh water tank, will run only as long as is needed. If the pump fails to start when the switch is on, check the fuse

located in the converter. If the pump continues to operate whether the faucets are opened or closed, check the water tank. It might be empty, or there might be a leak in the system. If the city water hose is connected, the pump is not required.

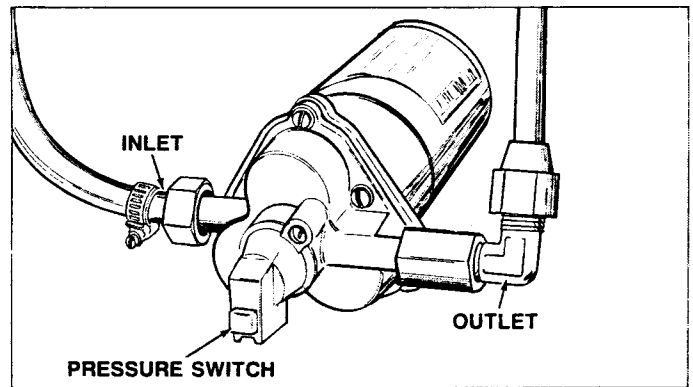

WATER PUMP

Sinks

Clean the kitchen and bathroom sinks with non-abrasive cleanser. Stainless steel cleaner may be purchased at most grocery stores. ABS cleaner, such as Aqua K-7, may be purchased from your authorized dealer.

Leaks

Traveling over bumpy or rough roads can cause pipe fittings to loosen. Check the pipe fittings in your unit regularly for signs of leakage.

Water Purifier

The optional water purifier installed in some models is designed to provide clear, good-tasting, bacteria-free drinking water. It is connected to the cold water line below the sink. See the manufacturer's instruction booklet for back-flushing the purifier element and maintenance.

NOTE: Replace filter cartridge if water pressure drops noticeably or a change in taste or the presence of an odor is evident. Refer to the purifier's owner's manual to replace cartridge.

CAUTION

Be certain to bypass water purifier before winterizing or sanitizing your water system. See manufacturer's manual.

Exterior Shower

A hand-held exterior shower (Figure 18, Page 43) is found on all MB/BH (Basement) models.

NOTE: For cold weather camping, the exterior shower assembly should be drained to avoid freeze-up. To winterize, simply close the shut off valves and open outside shower taps and hose connection point. (See Page 30.)

DRAINAGE/SEWER SYSTEM

Your RV is equipped with a drainage sewer system that functions much the same as the one in your home. In most units this system includes drain lines from the kitchen sinks, lavatory, tub/shower and marine type toilet to a gray-water holding tank and/or a sewage holding tank.

The drainage system also includes vents that carry odors (caused by drain water and waste) out through the roof. The drainage system vents also equalize the air pressure, which is necessary to maintain a water barrier against odors in the P-traps and to ensure smooth flow and escape for your drainage system.

Toilet

Flush the toilet before initial use and after emptying the holding tank. To help control odors, there are a number of toilet and holding tank treatment concentrates on the market. These chemical concentrates are available at your RV dealer.

The illustrations below show two of the toilet models found in most RV models. To operate Toilet A, step on the small pedal to add water to the bowl. When you have the desired amount of water in the bowl, slowly release the pedal. To flush this type of toilet, step on the large pedal until the water swirls and then slowly release the pedal.

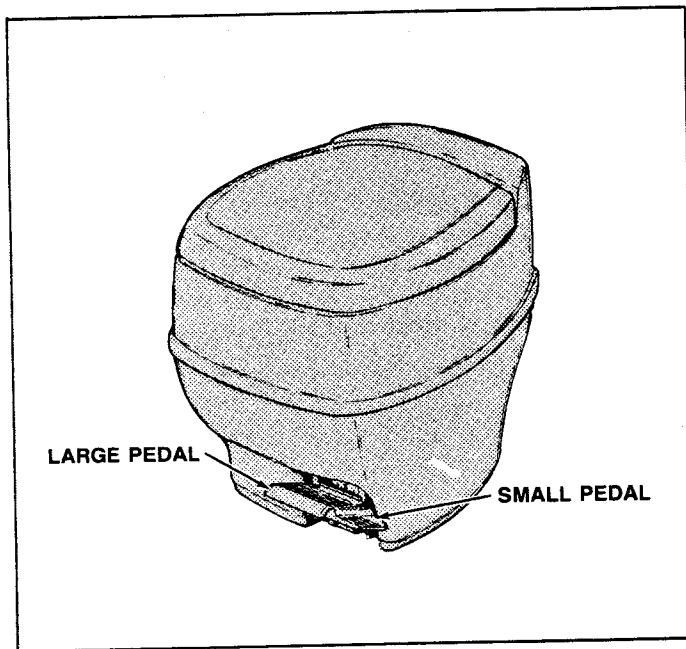

TOILET A

To operate Toilet B, pull the black lever, which empties the bowl, forward (the "open" position) and hold until all contents are swept into the holding tank. Always hold the black lever in the "open" position for a minimum of three seconds. The black lever simultaneously activates the white lever. When you release the black lever, the bowl will automatically fill with water for the next use. To add more water to the bowl, pull the white lever forward.

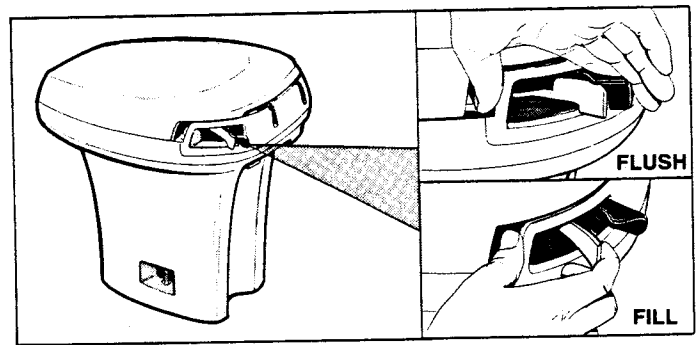

TOILET B

When you clean your toilet, do not use highly concentrated or highly acidic household cleaners (no scouring powder). If the slide valve does not move freely, apply silicone spray. To ensure proper operation and maintenance, refer to your toilet manufacturer's operating manual.

Holding Tanks

Most unit drainage/sewer systems have two holding tanks, Gray Water and Waste (black) Water. The gray water holding tank collects water from the kitchen sink, lavatory and tub/shower. The waste (black) water holding tank is used to collect waste from the toilet. In some units, one tank collects both gray water and sewage waste.

To prevent unnecessary accumulation of solids in the waste holding tank, do not put facial tissues or similar products into the toilet. It is highly recommended that you use only bio-degradable toilet tissue available from your RV dealer. Holding tanks should be emptied frequently into a specified dumping station. Most campgrounds have dumping stations, often at each campsite, and many service stations and highway rest areas have waste dumping stations also. Before emptying the holding tanks, make sure your vehicle is level; emptying the holding tanks depends on gravity.

To empty the holding tank, remove the sewage drain hose (Figure 9, Page 43) from its storage area. Remove the cap from the termination outlet and connect the sewage drain hose.

While you are camped you may leave the gray water dump valve open only if the hose is connected and your campsite has a sewage hookup. Do not open the waste water dump valve until you want to empty the holding tank. If the waste water dump valve is left open, the rinse and flush water will run off and solids will be left to collect and harden in the bottom of the tank (Figure 10, Page 43).

To drain a holding tank, pull out the dump valve slide handle. On some units it is necessary to unfasten or unlock a holding device before the slide valve handle can be pulled out. After the tank is drained, close the valve (if applicable, lock in place).

After emptying the waste holding tank, flush or pour about two gallons of water through the toilet and

drain again. This flushes the tank and helps clean the drain hose. Repeat as necessary.

To empty the gray water holding tank, follow the same procedure used to empty the waste holding tank. A flushing may not be necessary. When the tank is empty push the dump valve handle in until it seats (if applicable, lock in place). Remove the hose, wash it and return it to its storage holder. Replace the termination cap securely.

It is recommended that you always drain the sewage waste holding tank first, and then the gray water tank. This assists in flushing and cleaning the termination valve and drain hose.

Do not use harsh drain cleaner chemicals or solvents in the drains. Drain cleanouts are installed on certain units at intervals to facilitate drain line cleaning or unclogging. Use a wrench to remove and replace drain cleanout plug.

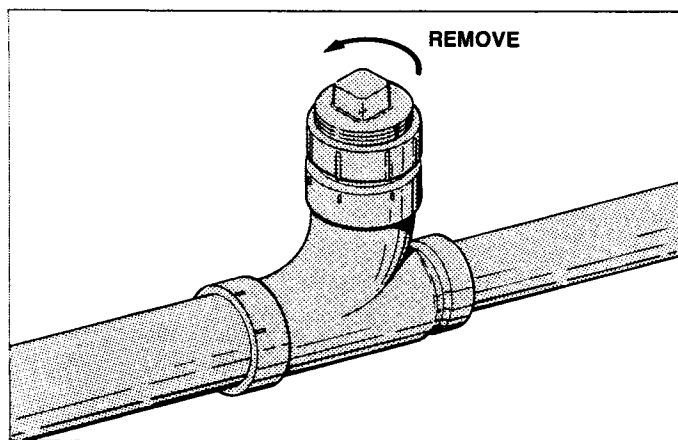

DRAIN CLEANOUT

LP GAS SYSTEM

The liquefied petroleum (LP) gas system in your unit furnishes fuel for hot water, heat, cooking and refrigeration (see illustration). LP gas provides a portable, efficient and inexpensive source of energy. It is stored in an LP gas tank which is mounted to the chassis of your unit and is serviced through an access door.

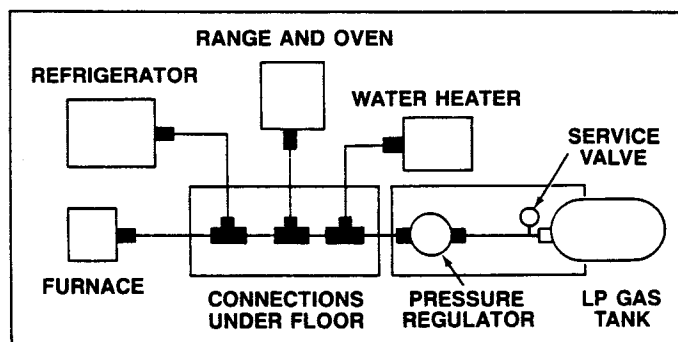

LP GAS SYSTEM (TYPICAL)

Under pressure in the tank, the LP gas turns to vapor; it is the latter that burns. Each tank has an automatic 80 percent stop-fill valve that allows space

in the tank for vapor expansion. The high pressure of the vapor in the tank is reduced in two stages through a regulator (Figure 11, Page 42). The tank pressure will vary with temperature and altitude, but may be reduced to about 12 psi in the first stage, then to about 6¼ ounces in the second stage (the 6¼ ounces per square inch also is expressed as 11 inches of water column).

LP gas is usually propane or a blend of propane and butane. When you fill your tanks, be sure to use propane **ONLY**. Do not use butane or butane mixtures.

The LP gas system is designed and built to meet rigid standards, and it is tested before it leaves the factory. Your dealer also tests the system before it is delivered to you. Except for simple maintenance and occasional tightening of a connection, always take your vehicle to an authorized dealer for LP gas problems. Always have an authorized LP gas supplier fill your LP gas tanks.

LP gas burns readily and with intense heat. With proper care and maintenance, it is safe and efficient. There are, however, certain characteristics about LP gas you should know. LP gas is heavier than air and tends to collect in low pockets. As LP gas settles into any closed area, it displaces air and could cause suffocation if not detected. It also could create a fire or explosion hazard. In its natural state, LP gas is odorless. An additive gives it a distinctive mustard odor so that leaks can be readily detected. The following label has been placed in the vehicle near the range area:

WARNING

If you smell or think you smell gas:

1. **Extinguish any open flames, pilot lights, all smoking materials;**
2. **Do not touch electrical switches;**
3. **Shut off the gas supply at the tank CLOSE valve(s) or gas supply connection;**
4. **Open doors and other non-electrical ventilating openings;**
5. **Leave the area until the odor clears, and**
6. **Immediately call your gas supplier, and have the gas system checked and leakage source corrected before using again.**

Before using any LP gas appliance, read the respective manufacturer's operating instruction manual.

NOTE: LP gas containers should not be placed or stored inside the living area of a vehicle. LP gas containers are equipped with safety devices that relieve excess pressure by discharging gas to the atmosphere.

Climate Differences

The appliance will not function if the LP gas does not vaporize. Propane continues to vaporize down to 44 degrees Fahrenheit below zero. Liquid gas does not vaporize as rapidly in cold weather, so you may place too great a demand on your tanks' capacities in certain conditions. This can cause a refrigeration effect resulting in frosting of the tank and regulator. Check with your dealer or LP gas supplier about the appliance demands that can be met by your tank at various temperatures. Always have your LP gas supplier add anhydrous methanol before filling the tank in cold weather.

Propane recently has become the main type of LP gas used in RVs. It is recommended that you use only propane gas. The names of LP suppliers can be found in the Yellow Pages of your telephone directory under "Gas — Liquefied Petroleum — Bottled & Bulk". Many campgrounds now have LP gas fill facilities, as do some service stations.

To operate any LP gas appliance, the LP gas SERVICE valve (Figure 11, Page 41) must be open. When first used, or after a refill, there may be some air in the gas lines that will escape when you first open a range burner or similar LP gas valve. The air may extinguish your match or igniter the first time or two before you get ignition. Remember, too, that when you close the tank's SERVICE valve some of the gas will remain in the lines. To completely bleed the lines of gas, close the tank's SERVICE valve and light a range burner to use up the excess. When the flame burns out, turn the range burner off.

Regulator Pressure

Check the LP gas regulator at the beginning of each season or whenever a problem is indicated. Correct line pressure is 11 inches of water column. Your dealer or LP gas supplier can perform this check.

LP gas regulators must always be installed with the diaphragm vent facing down. Regulators that are not in compartments have been equipped with a protective cover. Make sure that the regulator vent faces down and that the cover is kept in place. This will minimize vent blockage that could result in excessive gas pressure and could cause a fire or explosion.

LP Gas Regulator Freeze Ups

LP gas regulator freeze up is a problem RV owners can prevent if they are aware of its causes. Although every precaution is taken by fuel producers, tank manufacturers, and LP gas dealers to keep moisture out of the fuel, this problem at times does exist and causes regulator freeze ups. Suggestions that you may want to follow to help to prevent this moisture are:

1. Always keep the main tank valve closed during periods that gas is not in use, especially if the tank is empty; and

2. Contact your LP gas dealer about the addition of methyl alcohol to your tank. Your dealer may do this for a minimal charge, and it will help to prevent freeze up.

Filling LP Gas Tanks

Before having an LP gas tank filled, be certain all burners and pilot lights are off.

Drive your RV to an authorized LP supplier for filling (never remove the tank). He will connect the fill nozzle to the LP gas tank fill valve. When the tank is being filled, the Service valve must be CLOSED and the 20% liquid level gauge must be OPEN. The 80% stop fill valve may close the valve before liquid appears at the 20% liquid level gauge, but if liquid does appear, stop filling immediately; the tank is filled to its LP capacity. When liquid LP gas is no longer visible, close the liquid level gauge. Do not use a wrench to tighten the Service valve or the 20% gauge; they are designed to be closed leak-tight by hand. If you cannot hand-tighten properly, the valve probably needs repair or replacement.

Because there may be some leakage of LP gas when the tank is being filled, we recommend that you drive at least a mile away from the LP gas dealer's before you relight any pilots or appliances if the scent of LP gas is present. Open the windows and doors and wait 30 minutes. If the odor is still present, follow the instructions in the LP GAS LINE CHECK section.

WARNING

A warning label has been located near the LP gas container. This label reads:

DO NOT FILL CONTAINER(S) TO MORE THAN 80 PERCENT OF CAPACITY. Overfilling the LP gas container can result in an uncontrolled gas flow which can cause fire or explosion. A properly filled container will contain approximately 80 percent of its volume as liquid LP gas. If the tank is overfilled, have the LP gas dealer bleed out the excess. DO NOT smoke, strike a match, or ignite a lighter when the LP gas container is being filled. A spark or flame could ignite fumes. Be certain all burner and pilot flames are out and the Service Valve is closed when filling your vehicle's LP gas or fuel tanks.

LP Gas Line Check

Always check the gas line connection after each refill and inspect other connections regularly, at least every 30 days or 5,000 miles of travel. To check, turn off all burners and pilot lights. Open all doors and windows. Open the LP gas container Service valve and use a propane gas leak detector solution to test all line connections. Do not use products that contain ammonia or chlorine. Bubbles indicate a leak. Tighten the connections with two open end wrenches until bubbles stop. If leak persists, contact your dealer.

APPLIANCES AND ACCESSORIES

RANGE, RANGE HOOD, OVEN

Your RV may have a three- or four-burner range; it may have an oven beneath the range or at eye-level, and it may have a gravity range hood with a light, a power range hood with fan and light, or a range hood with fan only. The range burners and oven are LP gas appliances. Read the range manufacturer's manual carefully for complete details on the operation and care of the range, range hood and oven.

WARNING

IT IS NOT SAFE TO USE COOKING APPLIANCES FOR COMFORT HEATING.

Cooking appliances need fresh air for safe operation. Before operation:

1. Open overhead vent or turn on exhaust fan and
2. Open window.

This warning is to remind you to provide an adequate supply of fresh air for combustion. Unlike homes, the amount of oxygen supply is limited due to the size of the recreational vehicle. Proper ventilation when using the cooking appliance(s) will avoid dangers of asphyxiation. It is especially important that cooking appliances not be used for comfort heating as the danger of asphyxiation is greater when the appliance is used for long periods of time.

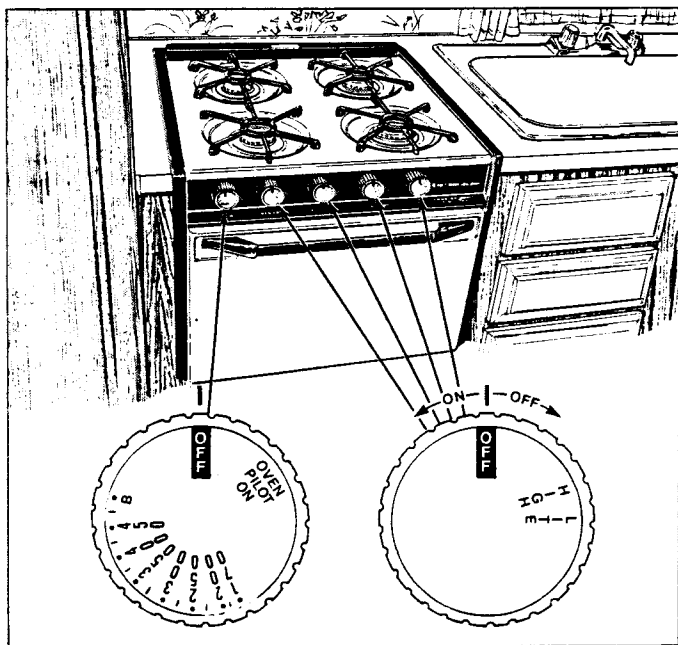

RANGE AND OVEN CONTROLS

LIGHTING THE PILOTS — There are pilot burners on all LP gas ovens and the eye-level range/oven also has a pilot for the range burners. All pilot lights, including the range burner pilot, are turned on and off by the oven control knob. If you

have the eye-level range/oven, you must light BOTH the oven pilot and range top pilot.

NOTE: The oven control knob must be in the PILOTS ON position for the pilot(s) to be lit. Once lighted, the pilot(s) will continue to burn.

To light the oven pilot, be certain the LP gas container Service valve is OPEN, then depress and turn the oven control knob to PILOTS ON. Open the oven door and hold a lighted match next to the constant pilot area (it is near the rear of the oven compartment, just below the main oven burner). Relight the pilot if air in the line extinguishes the flame. When the pilot remains lit, adjust the oven control knob to the desired temperature. If the oven is part of the eye-level model, light the range burner pilot before lighting the oven pilot.

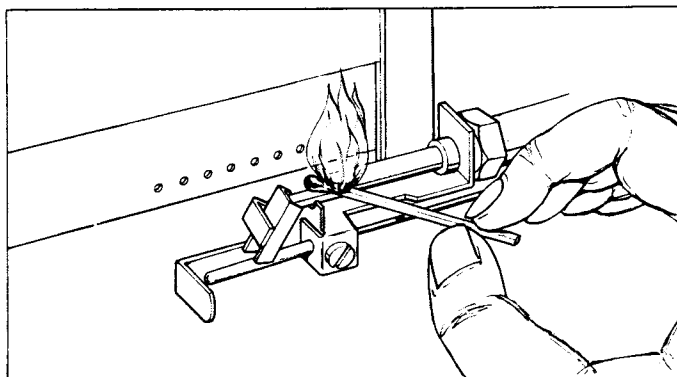

LIGHTING THE OVEN PILOT

To light the range burner pilot (eye-level range/oven models only) lift the main top panel and touch a lighted match to the pilot. Turn a range control knob full ON; if the burner lights, the pilot is operating properly.

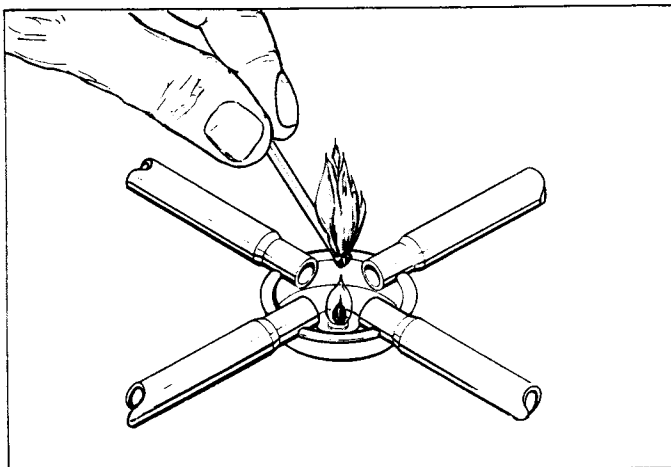

LIGHTING RANGE TOP PILOT

LIGHTING THE RANGE — Be certain the LP gas Service valve is OPEN. Light a match and hold it close to the range burner, then turn the burner's control knob to full ON. Air in the line may cause a blowing noise and may extinguish the match. When the line is free of air, the burner will light readily. Adjust the burner flame with the control knob.

BROILER — Your oven is equipped with a broiler. To use it, light the oven and set the control knob to BROIL. Place the broiler pan in the area below the oven burner. Do not place meat too close to the flame; grease or fat may ignite. Use foil only as recommended. Never cover the holes in the broiler pan or the air openings in the oven bottom with foil. Always remove the broiler pan as soon as you have finished broiling. If the pan is not removed and the oven is used, the grease may bake onto the surfaces or the grease may ignite.

RANGE HOOD — The light and/or fan of a power range hood are controlled by switches on the top. Most range hoods also have a damper which must be open during use. Pull the latch on the right side of the filter to release the damper. Use the fan to draw smoke and cooking fumes out of the unit. To secure the damper, push the latch in with fan off. Keep the damper closed when traveling.

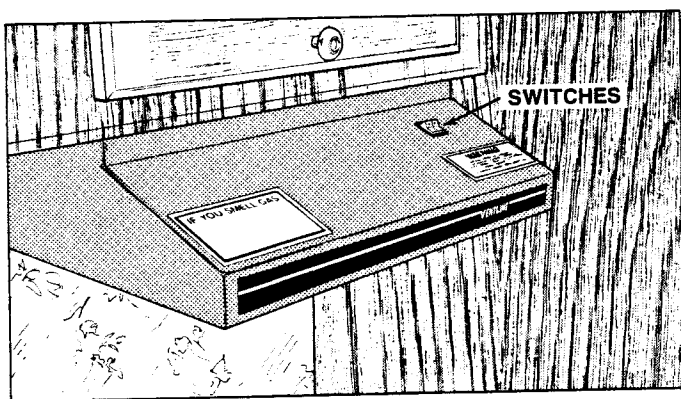

POWER RANGE HOOD

CARE OF RANGE AND OVEN — Allow the range top to cool, then clean it with hot, soapy water. Use a damp cloth to clean chrome surfaces. Grease splatters, which may bake onto the surfaces, should be wiped off before they have time to harden. Use chrome polish to remove stubborn stains.

Clean the oven with commercial cleaner after each trip, or as necessary. DO NOT apply cleaner to aluminum gas tubing, thermostat sensing bulb or electrical components.

CARE OF RANGE HOOD — For metal surfaces, use the same procedure as for the range top. For the power hood, clean the plastic light cover by removing and washing it. If the light burns out, replace with a bulb of the same size. To clean the power hood filter, push slot located in center front of screen and pull down. If not greasy, simply tap the filter to shake out the dirt. If the filter is greasy, run hot, soapy water over it until grease dissolves. Allow the filter to drain and dry, then replace by positioning the flanges and push into place. The gravity hood can be cleaned by gently rubbing a soapy cloth over the screen.

MICROWAVE OVEN — A microwave oven is a 120-volt appliance used to cook, defrost or simmer foods in less time than other cooking methods.

Several types of microwave ovens are installed by the manufacturer. Be certain to read carefully the oven manufacturer's owner's manual for specific instructions for the model which may be installed in your unit.

CONVECTION-MICROWAVE OVEN — Available as an option on some Class A models, the convection-microwave oven replaces the LP gas oven. For specific instructions on the operation and care of a convection-microwave oven, refer to the oven manufacturer's owner's manual.

WATER HEATER

The water heater is an LP gas appliance capable of heating 6 or 10 gallons of water to a preset temperature. The water heater may be a match light or electronic ignition. When the system is connected to city water, fill the water heater by opening a hot water faucet. When filling the fresh water tank, turn the water pump ON and open a hot water faucet. In either case, when water flows steadily, turn the faucet OFF. Any air still in the tank can be removed by opening the relief valve in the outside access compartment (Figures 12, 13, and 14, Page 41).

Before attempting to ignite any of the water heater models, be certain to OPEN the LP gas bottle Service valve.

ELECTRONIC IGNITION — Place the switch in ON position. If switch light comes on, place switch in OFF position and wait 5 minutes. The switch light will only come on in the event of water heater malfunction or if the flame fails to light. After required delay, again place switch in ON position. It may take more than one start attempt when unit is being used for the first time or after the LP gas bottle has been refilled. For complete shutdown, place switch in OFF position.

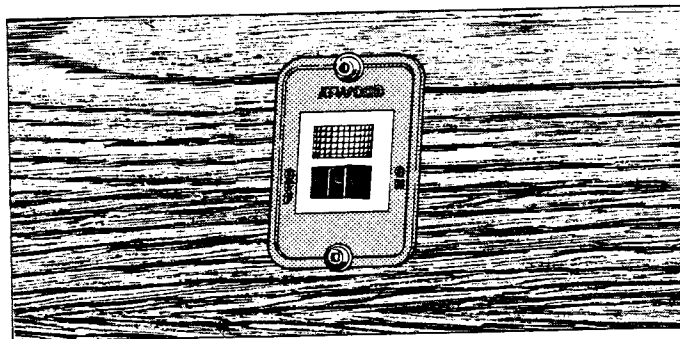

ELECTRONIC WATER HEATER SWITCH

LIGHTING PILOT — Turn the gas knob to OFF. Always wait 5 minutes to allow LP gas, which may have collected in the burner compartment, to dissipate. Your water heater will be equipped with a Robertshaw "UNITROL" thermostat (Figure 12, Page 41) or an ITT General Control Thermostat (Figure 13, Page 41).

CAUTION

DO NOT light pilot unless water heater is full of water.

ROBERTSHAW "UNITROL" THERMOSTAT — Turn the gas knob counterclockwise to PILOT. Press and hold the reset button while you apply a lighted match to the pilot burner. Release the reset button after pilot has burned one minute (repeat procedure if pilot goes out). Turn the gas knob to ON.

ITT GENERAL CONTROL THERMOSTAT — Turn and hold the gas knob to the PILOT position as you hold a lighted match to the pilot burner. Release the gas knob after one minute (repeat procedure if pilot goes out). Turn the gas knob to ON.

TEMPERATURE CONTROL — Adjust the Temperature Control lever on either Unitrol or ITT thermostat to the desired temperature as marked on the control.

The main burner will light automatically and burn as needed to maintain the temperature you have selected. It is a good idea to light the water heater the night before you leave and turn it off in the morning. The water will remain hot for some time while you are traveling.

PILOT ADJUSTMENT — Remove the pilot adjustment screw protective cap and turn set screw to adjust the flame so it is 1/2" high.

BURNER ADJUSTMENT — Loosen the set screw which holds the air shutter in place. Slide the main burner air shutter to the right until the flame has a yellow tip. Slowly slide the shutter to the left until the yellow tip disappears. Tighten set screw.

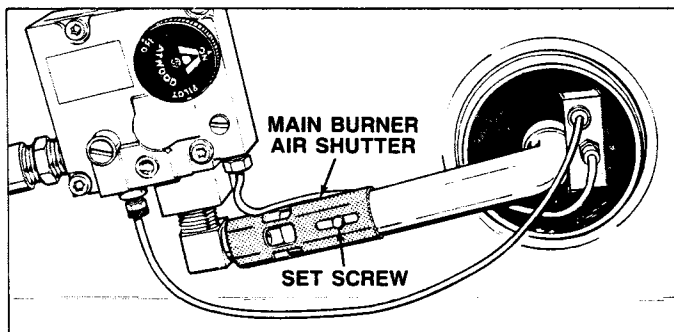

WATER HEATER BURNER ADJUSTMENT

EXTINGUISHING BURNER — Turn the gas knob to OFF.

DRAINING — The hot water system has a drain plug or drain cock in the line near the water heater which must be opened or removed to drain the water heater tank. To facilitate drainage, open all hot water faucets. When water ceases to drain, replace plug. Because of the location of the drain plug, about two quarts of water will remain in the bottom of the tank. This can be flushed as described in CARE OF WATER HEATER.

CAUTION

Hydrogen gas can be produced in a hot water system served by a heater that has not been used for a long period of time (generally two weeks or more). **HYDROGEN GAS IS EXTREMELY FLAMMABLE.** To reduce the risk of injury under these conditions, it is recommended that the hot water faucet be opened for several minutes at the kitchen sink before using any electrical appliance. If hydrogen is present, there should be an unusual sound such as air escaping through the pipe as the water begins to flow. There should be no smoking or open flame near the faucet at the time it is open. Contact your dealer or the Service Department at the address on the manufacturer's warranty if you are not certain of what action you should take.

CARE OF WATER HEATER — Be certain the exterior compartment is clean and does not contain combustible materials. Never obstruct the relief valve or exhaust vent. Periodically drain and flush the water heater tank.

To flush the tank, a water or air hose can be connected to the water inlet or outlet (inside the unit) or to the relief valve port (in exterior compartment). To use the relief valve port, the relief valve must be removed. Use a pipe or crescent wrench to turn the valve counterclockwise. Attach water or air hose and flush (if air is used, until water ceases to drain). Replace the water inlet or outlet hose or the relief valve and replace the plug. The water heater is now ready for refilling or storage.

NOTE: The relief valve must be replaced securely. Use a non-toxic pipe compound to assure a water tight seal.

FURNACE

Furnaces may be piezo or automatic ignition, controlled by a wall thermostat. Heat is delivered through a duct system or directly through the front grille.

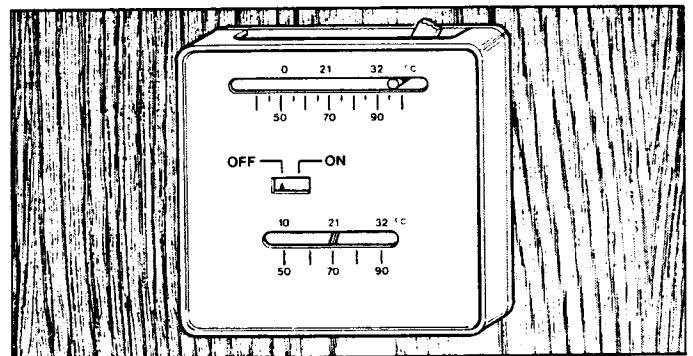

THERMOSTAT

NOTE: Although the furnace's fuel source is LP gas, the power operates on 12-volt DC electricity. The furnace requires 9 volts of 12-volt energy to operate.

CAUTION

DO NOT use portable fuel-burning heating appliances, including kerosene heaters, wood and charcoal grills and stoves, in your recreational vehicle. Such appliances produce excessive moisture, consume oxygen and may emit dangerous products of combustion.

IGNITION — Before lighting a furnace, be sure the LP gas bottle Service valve is OPEN and the thermostat ON/OFF switch is ON.

Piezo Model — Turn the manual gas valve on the furnace to ON. Press gas valve button in and light by pushing in on igniter repeatedly until pilot lights. Hold gas valve button in for one minute or until pilot remains lit. Set thermostat to desired temperature. For complete shutdown, turn manual gas valve to OFF, set thermostat to lowest setting and then turn ON/OFF switch on thermostat to OFF.

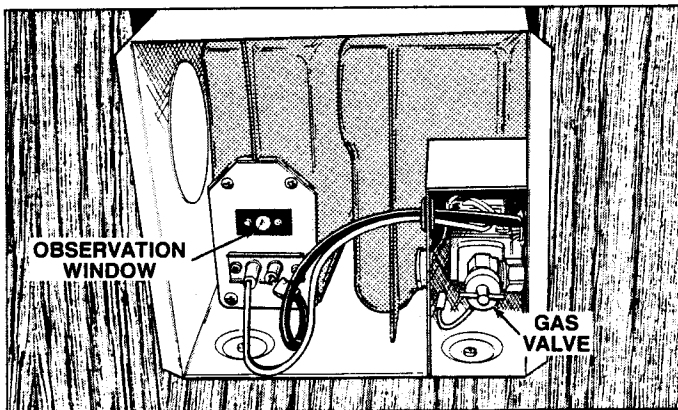

DIRECT VENT FURNACE

Automatic Models — Turn manual gas valve to ON. Set thermostat to desired temperature and turn ON/OFF switch to ON. An automatic relay in your furnace provides a time delay. Therefore, when you turn up the thermostat there will be a pause prior to startup of the blower. At blower startup, your furnace air will enter your living quarters at room temperature.

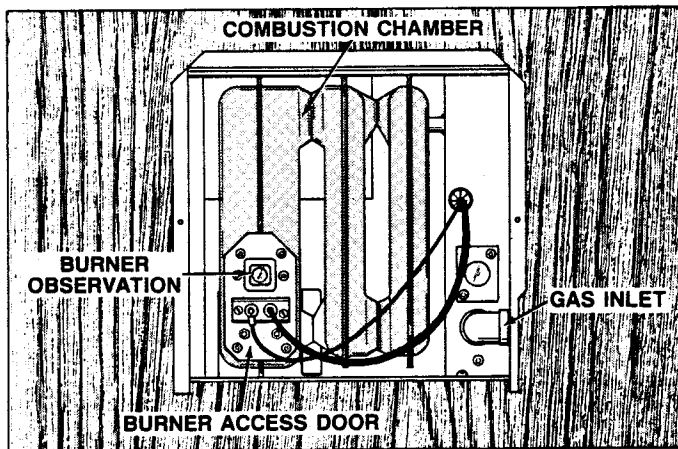

DUCT SYSTEM FURNACE

Your furnace will start warming quickly and continue getting warmer for the next several minutes. If your RV is cold throughout, it may take from one to several hours to heat all interior walls, ceilings, floors and fixtures to a comfortable temperature. Once reached, your furnace will automatically maintain steady warmth.

On initial lighting, the burner may not ignite due to air in the gas lines. If this occurs, set the thermostat back to lowest setting and wait 30 seconds; then reset thermostat to the desired temperature.

NOTE: If the furnace does not light after several attempts, while allowing each time for a delay pause, turn the thermostat and the furnace gas control valve OFF and contact your RV dealer or service center. DO NOT attempt to repair or adjust the furnace yourself.

For complete shutdown, turn gas valve to OFF and the thermostat to lowest setting or OFF.

CAUTION

When changing your unit's electrical source, as from 12-volt to Shoreline or generator, turn the thermostat off. This will preserve the life of your furnace's electronic system. Carefully read the furnace manufacturer's manual for other important Do's and Don'ts of service and operation.

PREVENTATIVE MAINTENANCE — Preventative maintenance should be performed annually by an authorized dealer and should include cleaning of heat exchanger, furnace ducts (Figure 15, Page 42) and blower wheels to remove dust, lint and other foreign materials. The furnace's LP gas system should also be checked.

REFRIGERATOR

Refrigerators are either two-way (LP gas and 120-volt electricity) or three-way (LP gas, 120-volt AC or 12-volt DC). All come with operational instructions and most have instructions posted near the controls. Ask your dealer to demonstrate the operation of the refrigerator in your unit. The instructions given here are for your convenience; in case of a difference, use the instructions furnished with your refrigerator.

The refrigerator operates on the gravity flow of chemicals, so it must be level. If you must stop on an uneven site for more than 30 minutes, turn the refrigerator OFF. Use a level in the freezer compartment to check levelness.

Before starting on a trip, use the Shoreline connection to cool the refrigerator the night before departing. Keep items to be stored in the RV refrigerator in your home refrigerator or freezer until you are ready to leave. This will reduce the cooling load on your RV refrigerator and help keep perishable foods fresh longer. Always store food in sealable containers

or suitable wrapping. When traveling, switch to LP gas (or 12-volt DC, if so equipped) operation. Use door lock during travel.

NOTE: Some states and municipalities do not allow operation of LP gas systems while the vehicle is in motion. If you have a question in this regard, check with local law enforcement authorities.

PUSH-BUTTON OPERATION (NORCOLD) — This model has switches near the top of the refrigerator to select the type of operation you desire. A colored light will come on to indicate that the type of energy you have selected is operating properly; amber for 12-volt, blue for LP gas, and green for 120-volt. Many refrigerators now being installed are two-way, without the 12-volt mode. On all modes, turn the thermostat to Max. Cold position when starting, then later adjust the thermostat to the desired temperature. When using LP gas, if ignition does not occur, a Check (CK) Light will come on. To restart when Check Light is on, depress the switch to the OFF position and wait 10 seconds. Then depress switch again to the LP gas position. If you have just refilled your LP gas bottles, this operation may have to be repeated four times. Do not continue to reset the LP gas switch if the Check Light continues to come on after four attempts. If the Check Light comes on, turn the switch to OFF and check your LP gas supply. If you have an ample LP gas supply, consult your dealer.

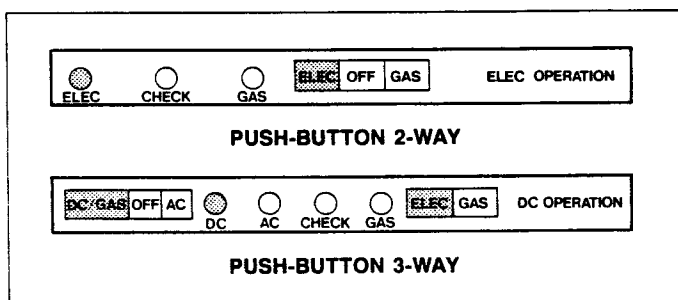

NORCOLD REFRIGERATOR CONTROLS

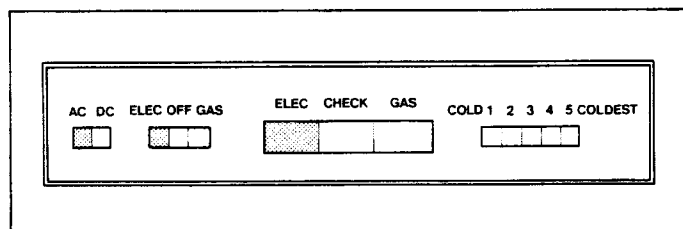

NORCOLD FLUSH MOUNT CONTROLS

CARE OF REFRIGERATOR — Remove food and ice after each trip. Clean the interior of the refrigerator with a lukewarm, mild soda solution. The evaporator, ice trays and shelves must, however, be cleaned with warm water only. Wipe dry with a soft, dry cloth. Never use strong chemicals or abrasives to clean the refrigerator; they can do harm to the plastic and aluminum surfaces. If the refrigerator is not in use for a period of time, turn all power off,

empty and clean the interior and leave the door slightly ajar.

To defrost refrigerator freezer, remove food and ice. Turn the thermostat OFF. To speed up the defrosting process, fill the ice trays with hot water. When all frost is melted, empty the drip tray and dry the interior of the refrigerator with a clean cloth. Replace the drip tray and ice trays, replace all food stuffs and set the thermostat at MAX for a few hours. Later, reset the thermostat knob to its normal position.

ROOF AIR CONDITIONER

If you did not order the optional roof air conditioner at the time of purchase, your unit may be wired so that one can be installed later; ask your dealer. The roof air conditioner will operate only on 120-volt electricity.

More than one type of roof air conditioner is installed at the factory. Consult your dealer and your roof air conditioner manufacturer's manual for specific instructions for the one installed in your unit.

Before starting any model of roof air conditioner, close all doors and windows. The controls for the air conditioner are on a panel on the portion of the appliance that is attached to the ceiling inside your unit. You can select cooling, fan only, or—with the optional heat package—heating.

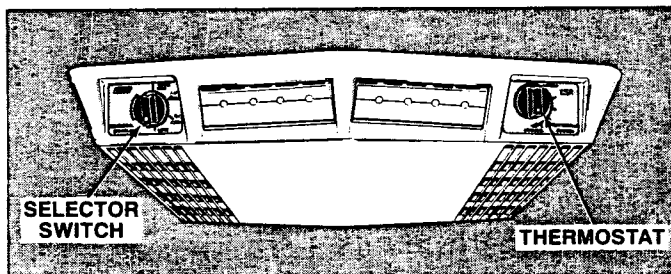

ROOF AIR CONDITIONER CONTROLS

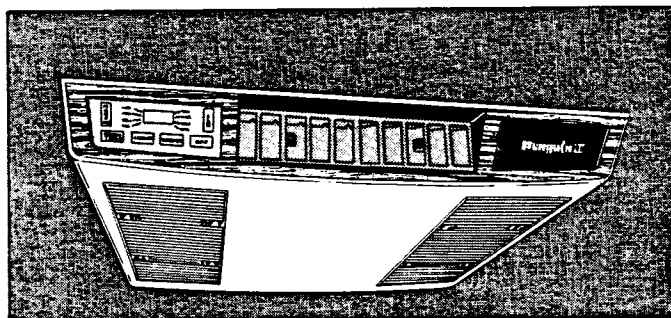

LOW PROFILE DIGITAL AIR CONDITIONER CONTROLS

AIR CIRCULATING ONLY/COOLING — Turn the Selector Switch to COOLING, then rotate the thermostat to the position that is most comfortable to you and adjust the directional louvers to the desired direction of air flow. The compressor will cycle on and off, automatically maintaining the temperature you've set.

HEAT — The optional heat unit on some models is not a substitute for a primary heating system. It is designed to warm the air during moderately cool days or nights. If your air conditioner is equipped with the optional heat package, turn the selector switch to HEAT and rotate the thermostat to the position most comfortable and adjust the directional louvers to the desired direction of air flow. The heater will cycle on and off automatically to maintain the temperature.

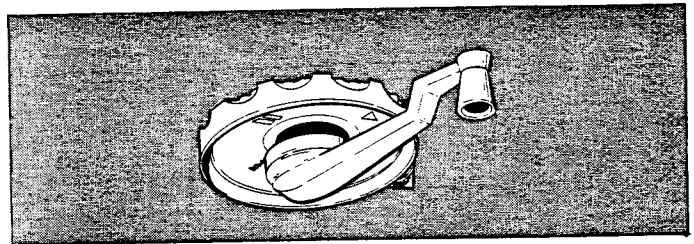

TV ANTENNA CONTROL

OPTIONAL LIVING AREA FEATURES

Your Class A or mini motorhome may be equipped with optional items you have chosen. For complete operating instructions for those mentioned here and any others you may have selected, please refer to the manufacturer's owner's manual.

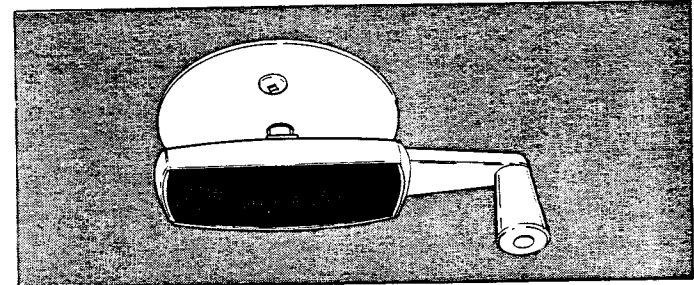

SKYLINER ANTENNA CONTROL

AM/FM RADIO AND/OR CASSETTE TAPE PLAYER

For optimum performance, clean the tape head as often as necessary, depending on frequency of use. The tape head on most models can be cleaned with a special cleaning cassette cartridge; others can be cleaned with isopropyl alcohol on a cotton swab. Keep cassette tapes away from magnetized objects and follow manufacturer's recommendations for tape types and length. For specific operating instructions, cleaning, tuning and helpful hints, read your radio/tape player manufacturer's manual.

Always lower the antenna before moving your unit. Turn the rotating portion so that its pointer lines up with the ceiling plate pointer. Turn crank handle in DOWN direction until some resistance is felt. Always turn off the amplifier power switch.

NOTE: Even though your 12-volt radio and/or TV antenna will operate on the 12-volt current that is supplied through the power converter, spikes and surges in the current are possible and will result in poor reception. It is recommended, therefore, that these items be used only in conjunction with a properly installed RV battery.

TV ANTENNA

Television reception can be better in many areas with an optional RV antenna. The TV antenna hookup includes an amplifying system, a coaxial connection for the antenna cable to your TV set, and a TV crank for inside control. Some systems also have 12-volt receptacles for TV sets designed to run on 12-volt DC power. The cable connection, amplifying system switch and power ON indicator light are on a wall plate. Several types are used so refer to the manufacturer's instructions for details. The "Skyliner" antenna is installed with a 300-ohm cable and does not require an amplifier.

CABLE TV

An optional cable TV jack is located in the shoreline compartment (Figure 3, Page 43).

SECURITY SYSTEM

An optional security system will protect your unit when you are away from it. To activate, simply depress the lithium-powered transmitter for one full second. A single loud "chirp" verifies that the system is on and will instantly activate if any entry is attempted through doors. To deactivate the system, again press the lithium-powered transmitter for one full second.

NOTE: Additional transmitters are available from your dealer.

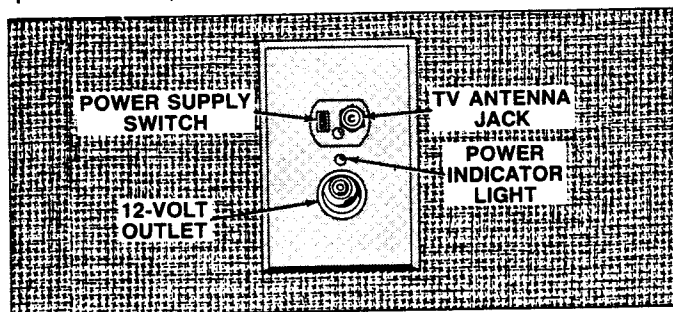

TV WALL PLATE

LP LEAK DETECTOR

It is recommended that your optional LP Leak Detector be in the ON position whenever you are using your motorhome. The system should be turned off when the vehicle is in storage or will be unused for several days.

HYDRAULIC LEVELERS

Controls for your optional hydraulic levelers are located in the cockpit or dashboard of your

Turn the antenna crank handle in the UP direction until some resistance is felt. Pull down the rotating knob to disengage it from the ceiling plate and turn it until you find the best sound and signal.

motorhome. To activate, the motor must be running. Turn the master switch on and press the automatic leveling switch. This will trigger the release of all four jacks which will automatically level your coach. When the leveling is completed, a red indicator light on the dashboard will turn on. Turn off the motor and the indicator light will go off also.

To raise the jacks, start the motor and push the automatic retract button. Jacks will return to the traveling position.

Individual jacks can be used by turning the master switch on and activating the desired jack control switch located below the master switch.

NOTE: Hydraulic levelers should not be used for tire change. See TIRE CHANGE on Page 34.

VACUUM CLEANER

Before using your optional built-in vacuum cleaner, check to see that a filter bag is in place. To activate the cleaner, lift the hose connection lid and insert hose. The vacuum cleaner will function on AC power (using the Shoreline or generator). To shut down, remove the hose and the cleaner will automatically turn off.

NOTE: Change filter bags frequently, depending on use. Additional bags may be obtained from your dealer.

FOOD CENTER

For complete operating instructions refer to the manufacturer's manual. You will note that many accessories are available for your Food Center. Because of installation requirements, not all accessories will fit all Food Centers. Check with your dealer if you wish to add accessories.

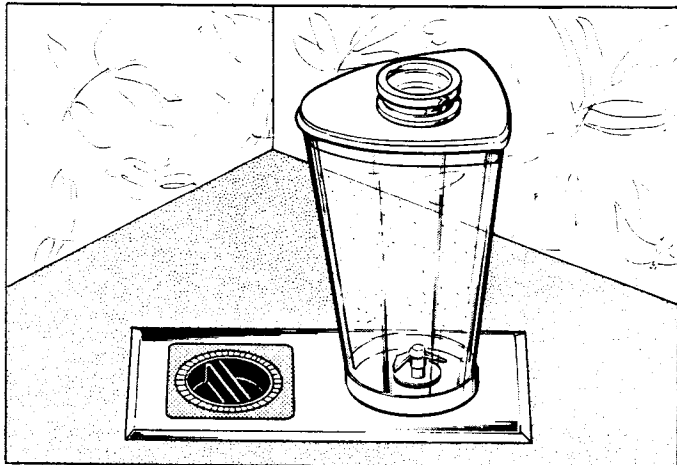

FOOD CENTER

BATTERY DISCONNECT

The Battery Disconnect can be utilized for either the coach or chassis battery. To operate the Battery Disconnect, press the USE/STORE switch to the USE position for either the coach or chassis. The indicator light for that battery will glow. To prevent the discharge

of your batteries, press the USE/STORE switch to the STORE position. Do this for both batteries.

ICE MAKER

Some models have ice makers. Never use an ice pick to loosen cubes. Defrost the ice maker periodically. When ice maker is not in use for some time, prop the door open about two inches. Do not use any electrical devices to defrost the ice maker. Make sure the front grille is clean, permitting good air flow. Please refer to the ice maker manufacturer's instructions for specifics on operation and maintenance.

DIGITAL CLOCK

A dashboard-mounted digital clock is standard on most models. Several types are used. Carefully read the instructions provided by the clock manufacturer for setting and operating procedures. Have your dealer demonstrate the clock's functions.

ELECTRIC STEP

Some models have the optional electric step (Figure 16, Page 43). Read the step manufacturer's manual for details on operation and maintenance. The basic operation:

With the entrance door open, flip wall switch ON. Close door and step should retract and lock in UP position. Open door, step should descend and lock in extended position with under-step light on.

Flip the wall switch OFF and step should remain in down extended position, with under-step light off. When door is closed this will also retain step in the up position.

With wall switch OFF, step extended with the entrance door closed, turn on ignition switch; the special wall switch override circuit will go into action and your step which was mistakenly left down will retract automatically. If this occurs, when you next stop and turn the ignition off and open the exit door, the step will remain in UP position until you flip the wall switch to ON. The step will then descend and lock in the extended position.

NOTE: When ignition switch remains on, the step will always activate with entrance door movement regardless of where wall switch is set.

STORAGE

You should follow these procedures if you will not be using your unit for an extended period:

LP GAS

Close the LP gas container's Service valve. Extinguish all pilots and close all appliance LP gas valves (oven/range, water heater, refrigerator, furnace). Light a range burner to consume any gas

remaining in the lines. When the flame burns out, turn the range burner off.

WATER HEATER

Drain the water heater. To drain, see Water Heater Draining in the APPLIANCE section of this manual.

WATER TANK

To drain the water tank, switch the water pump on and open all faucets. Remove the water tank's exterior drain cap (Figure 17, Page 42), if so equipped, or open the tank's drain valve. Open all hot and cold water line drain valves. When the tank is empty, close all faucets and drain valves, and replace the drain cap.

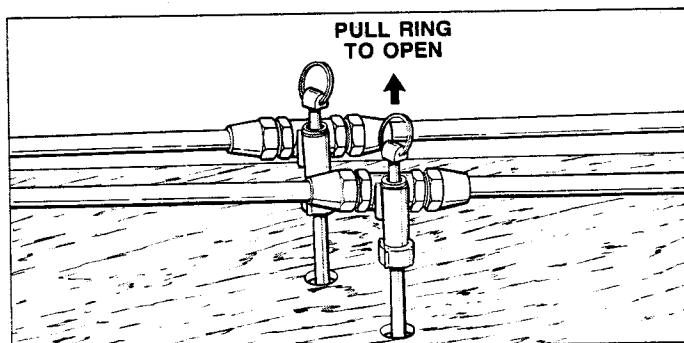

WATER LINE DRAIN VALVES

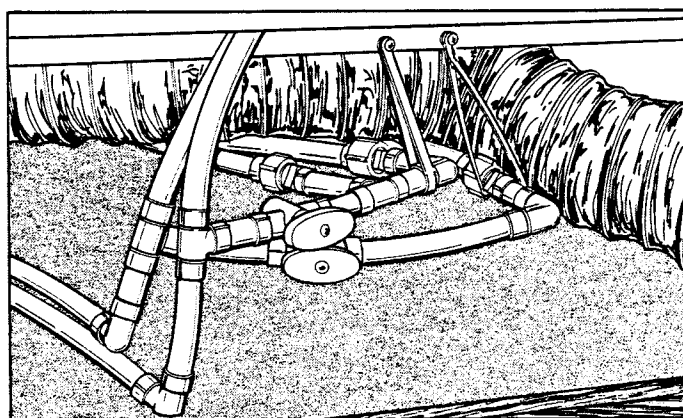

EXTERIOR SHOWER SHUT OFF VALVES

WATER PUMP

When the water tank and water lines have been drained, remove the outlet hose from the pump. Turn the pump on, allowing it to pump out any remaining water, usually about a cupful. Use a towel or cloth to catch this water. Reattach the outlet hose.

ELECTRICAL SYSTEM

Turn off all circuit breakers at the Power Center.

GENERAL

Close and secure all doors and windows. Open a roof vent or window slightly to allow circulation, but not so far that rain or snow can enter.

WINTERIZATION

Make special preparations for storing your unit in cold winter climates. All systems and components should be inspected and, if necessary, repaired prior to storage. Winterize the unit before removing the RV battery.

*NOTE: If you will be using your vehicle during cold weather, be certain to keep the fresh water system drained or use an **approved, non-toxic RV antifreeze** to prevent freeze-ups. Have an LP gas supplier add anhydrous methanol to your LP gas containers. Consult your authorized dealer for more information.*

REFRIGERATOR: Remove all food from the refrigerator, defrost and wash and dry the inside. Prop the door open so air can circulate.

CABINETS: Check the staple foods in your cupboards and remove any that could freeze and be damaged. Leave cabinet and closet doors open a bit to prevent a musty odor or mildew.

HOLDING TANKS: The dump valve shafts should be inspected and lubricated, if necessary. Be certain the dump valves are closed.

FRESH WATER SYSTEM: Drain as described in the STORAGE section of this manual, then pour six gallons of non-toxic RV antifreeze into the gravity water fill. This will allow you to winterize the remainder of the fresh water system. Winterize the fresh water system by briefly opening all water faucets and switching the water pump on. Close the faucets when antifreeze flows out. Switch the pump off. Pour non-toxic antifreeze into both kitchen sinks and the shower drain, enough to fill P-traps.

CAUTION

Do not use automotive antifreeze in the water system. It is poisonous.

WATER HEATER: Drain (see Water Heater Draining in APPLIANCE section). Although about two quarts of water will remain after the heater has been drained, there is ample room for expansion if it freezes. Add antifreeze to the water heater tank by opening a hot water faucet. When antifreeze appears at the spout, close the faucet.

WATER TANK: Drain by switching the water pump on and opening all faucets. Remove the water tank's exterior drain cap, if so equipped, or open the tank's drain valve. Open all hot and cold water line drain valves. When the tank is empty, close all faucets and drain valves, and replace the drain cap.

WATER PUMP: The water pump should be drained when the water tank and water lines have been drained. Remove the outlet hose from the pump. Turn pump on, allowing it to pump out any remaining water, usually about a cupful. Use a towel

or other cloth to catch this water. You can reattach the outlet hose now or later.

TOILET: Flush toilet until antifreeze is present in the bowl. Pour one gallon of fresh-water antifreeze down the toilet to winterize the waste water holding tank. The toilet water supply line should be drained completely and the water supply valve should be left open. On models with pedals, this can be done by inserting a round object, like a soft drink bottle, into the flush hole in the bowl. On models with the black/white levers, block the white lever in the open position with a wad of paper. When using air pressure to drain the water line, toilet valve should be held in the open position. If water is inadvertently frozen in the toilet, do not flush until the ice is thawed.

LP GAS REGULATOR: Cover to keep moisture out of vent. LP gas system should be prepared as described in **STORAGE** section. Containers should have anhydrous methanol added by an LP gas supplier.

RV BATTERY: Recharge and add water, if necessary. Disconnect the battery cables and store battery in a cool, dry place. Check regularly and recharge as needed. Do not store battery in an area where possible exposure to extreme heat or sparks can occur. Be sure room is properly ventilated to dispel hydrogen fumes given off by battery.

WINDOWS: Cover with newspaper or cardboard to protect fabrics from fading.

EXTERIOR VENTS: Cover range hood, refrigerator and furnace vents with plastic. Inspect all roof vents and replace, if necessary.

NOTE: Never use appliances with vent covers in place.

EXTERIOR: Clean and wax, lubricate locks and hinges. Check under the RV for any openings which would allow varmints to enter; seal if necessary. Lock securely. Inspect throughout the winter months and remove any snow accumulation from the roof with a long-handled broom or similar tool.

FIRE SAFETY

Prevention is the best form of fire safety. Observe the same precautions in your RV as you do in your home.

Use care with any open flame inside of your unit. Follow the instructions previously listed for the care and maintenance, and operation of the various appliances in your RV.

Make certain everyone in your party is familiar with the emergency features of the unit, the location of exits and the location and operation of fire extinguishers. A chemical fire extinguisher has been furnished with your unit. Check it regularly to be sure it is ready for emergency use. Immediately replace

a fire extinguisher that is discharged or partially discharged. Fire extinguishers are located directly inside the front entrance door on either a cabinet or on the sidewall.

Do not bring or store LP gas containers, gasoline or other flammable liquids inside your RV.

SMOKE DETECTOR

If your RV has a smoke detector, test it after the vehicle has been in storage, before each trip, and at least once a week during the time you actually use your RV.

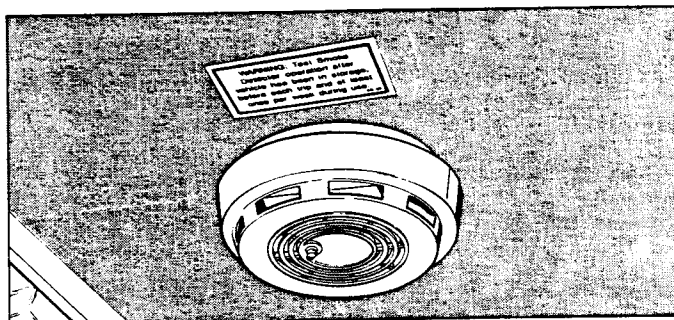

SMOKE DETECTOR

EMERGENCY EXITS

Emergency exits are installed in some models. These will be marked by a label which has one-inch red letters. Handles that must be operated to open emergency exits also will be colored red. Make certain your dealer explains the location and operation of emergency exits to you, and that you inform all members of your party.

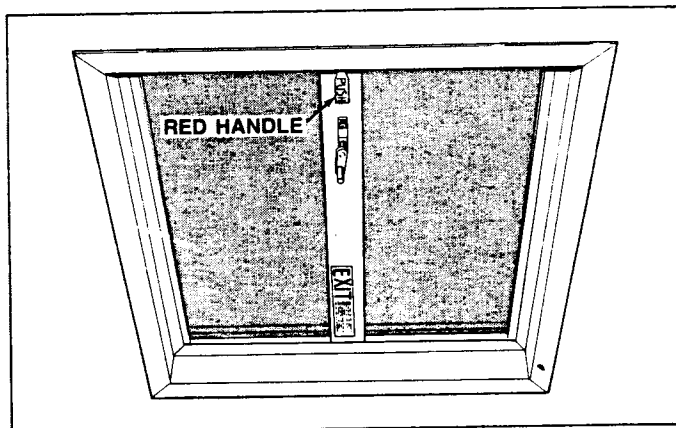
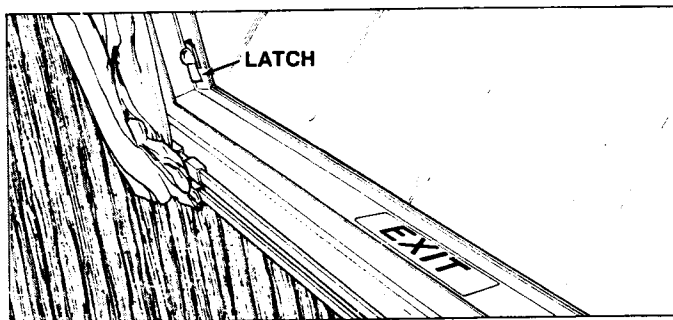

EMERGENCY EXITS

RV MAINTENANCE

RV owners are noted for the pride they take in the appearance of their units. Proper maintenance will do more than keep your RV looking nice. It can help ensure trouble-free operation and maximum efficiency of the appliance and accessories. Failure to maintain the vehicle or its components may also constitute a breach of your warranty obligations. Read the various appliance and component manufacturers' manuals for specific maintenance information.

Unless otherwise noted, maintenance functions should be performed at least annually. All maintenance schedules listed are the minimum requirement; heavy use, unusual temperatures or humidity, or other environmental conditions may require more frequent maintenance. At the start of each season, or after a period of storage, thoroughly inspect and test all systems and components to be certain they are functioning properly before you use your RV.

AIRING of the unit is essential before you occupy it. See details under the AIR QUALITY and CONDENSATION sections of this manual. AWNING RAILS and bright metal parts should be cleaned and coated with silicone annually. Clean front rockguards with a mild liquid diswashing detergent.

AUTOMOTIVE SYSTEM of your vehicle should be serviced and maintained as outlined in the chassis owner's manual. Have your authorized dealer explain the operation of the engine cover latches.

CAUTION

The interior engine access cover must be properly sealed to prevent engine exhaust from entering the living area of the vehicle. Make certain that carpeting or other materials do not interfere with the installation of the access cover.

AXLE AND SUSPENSION system should be inspected frequently; paint and adjust as necessary.

BATTERIES should be inspected frequently and refilled or recharged as necessary; battery cables and terminals should be checked and cleaned every 90 days.

BODY should be washed to remove dirt, dust, road tar, bird and tree droppings, insects, and other foreign material from exterior surfaces. Use a mild soap in lukewarm water. Apply an automotive-type wax at least once a year.

BUMPERS AND FRAMES that are painted, or any exposed painted surface, should be inspected for damage and rust. Rust should be removed and bumper and frame painted with rust preventive paint annually.

COUNTER AND TABLE TOPS should be cleaned periodically with a mild detergent and polished with a product such as Pride or Pledge.

ELECTRICAL SYSTEM should be inspected and tested prior to each trip. Check the Shoreline for damage. Test the 120-volt system for proper polarity and voltage. You may want to purchase a ground monitor and a line voltage tester to perform these checks.

FABRICS need regular and continuing care. To keep them at their best, vacuum and brush away loose dirt before it becomes embedded and more difficult to remove. Clean spills and stains while fresh. VELVET fabrics should be cleaned with extreme care. Spills on velvet generally will bead-up. Blot them up quickly and gently so as not to force the stain deep into the fabric. If a stain remains, spot-clean using one of the methods described below. Wipe the stain in the direction of the pile to prevent distortion. When the fabric is dry, gently brush with a soft brush. Many velvet fabrics cannot be cleaned with water-based cleaning agents.

DRAPERIES, CURTAINS, BEDSPREADS should be dry-cleaned only.

CUSHIONS, CHAIRS, SOFAS may be labeled with the voluntary industry cleanability code. Because dyes or backings on some upholstery fabrics will be affected by water or solvents, the cleanability code will indicate the cleaning method that is safe for your fabric. If the furniture is not coded, test the fabric for discoloration on an inconspicuous part of the furniture before spot-cleaning. The code is symbolized by the following letters:

W — Use only water-based cleaning agents or foam. Mix two tablespoons ammonia or detergent, such as Ajax liquid, with a quart of water. Wipe the stain gently with a clean cloth dampened with the solution. Continue wiping, turning the cloth so that you are always using a clean portion, until the stain is removed. Be careful not to wet the fabric too much. Always wipe from the outer edge of the stain toward the center.

S — Use only mild, pure, water-free dry-cleaning solvents, such as Energine or Carbona. Dampen a clean cloth with the solvent and follow the same procedure described under W.

WS — Either of the above methods may be used.

X — Clean fabric only by vacuuming or light brushing to remove soil. Do not use liquid cleaning agents of any kind.

TYPES OF STAINS:

WATER-BASED — ketchup, soft drinks, milk, etc. Remove using method W.

OIL-BASED — salad dressing, butter, greasy foods, etc. Use method S or, for flat-woven fabrics, not velvet, apply Texize K₂R Spot Remover according to directions.

COMBINATION — ice cream, gravy, etc. are both watery and oily. Remove these types of stains using the S method and follow with the W method.

MUD — lift away what you can easily remove without forcing the mud into the fabric. Allow the remaining mud to dry completely, then vacuum. If the stain remains, clean with method W.

When overall cleaning is necessary, professional cleaners are recommended. However, if you wish to do it yourself, follow these suggestions:

1. Vacuum thoroughly.
2. Test fabric for discoloration on an inconspicuous place using a foam cleaner such as Fibre Fresh Concentrate or Glamorene.
3. If no discoloration appears, use cleaner on entire item. *NOTE: Many velvet fabrics cannot be cleaned with water-based cleaning agents.*
4. After cleaning, you may wish to apply Scotch-guard fabric protector to such areas as furniture arms, backs and cushions.

NOTE: The above information is provided only as a service and should not be interpreted as a warranty. The list of cleaning agents does not constitute an endorsement of products; other similar products may be equally effective.

FLOOR COVERINGS should be cleaned as necessary. Damp mop vinyl floors and vacuum carpeting. Avoid using heavy moisture; it could enter and damage your floor.

HINGES should be inspected and lubricated with light household oil annually.

LOCKS AND LATCHES should be inspected and lightly lubricated with graphite at least annually.

LP GAS system should be inspected and adjusted as outlined in LP GAS section of this manual. Be certain mounting supports for tanks and bottles are secure. Before using, be sure all LP gas orifices and vents are clean.

LP GAS LINE CHECK should be performed frequently. Always check the gas line connection after each refill and inspect other connections regularly, at least every 30 days or 5,000 miles of travel. To check, turn off all burners and pilot lights. Open all doors and windows. Open the LP gas bottle Service valve and use an approved LP leak detector solution to test all line connections. Do not use products that contain ammonia or chlorine. Bubbles indicate a leak. Tighten the connection with two open end wrenches until bubbles stop. If leak persists, contact your dealer.

LUG NUTS should be checked every 50 miles for the first 200 miles or whenever a wheel has been reinstalled. If lug nuts continue to loosen, they should be replaced. Be certain to use the proper torque (85 to 95 ft./lbs. standard steel wheels and 125 ft./lbs. for aluminum wheels).

ROOF, BODY, UNDERBELLY should be inspected for damage, rust or corrosion every 90 days and repaired as necessary. You may wish to under-

coat the underbelly metal.

SEAMS OR JOINTS should be sealed around the roof, entrance doors, windows, roof and wall vents, access doors, storage compartments, roof edges, luggage racks, ladders, air conditioners, TV antenna, rails and moldings at least once each year with a similar high-quality sealant. Inspect all seams and joints at least twice a year and reseal as necessary. Some sealants cannot be applied over other types; when preparing areas to be resealed, scrape off old sealant. Clean metal areas with a vinegar and warm water solution. Clean fiberglass areas with mineral spirits before applying new sealant.

SHADES, BLINDS AND VALANCES should be vacuumed or wiped with a damp cloth.

SINKS in your unit's kitchen and bathroom should be cleaned with a cleaner that is non-abrasive. Stainless steel cleaner may be purchased at most grocery stores. ABS cleaner may be purchased from your authorized dealer.

STEP(S) should be inspected annually. Remove rust, and paint steps, lubricating moving parts.

TIRES should be checked for damage and proper inflation prior to each trip. Bias-ply tires should be balanced and rotated annually; radial tires should be balanced as necessary but, if required, these tires should be rotated front-to-rear or rear-to-front, only.

TV ANTENNA exterior moving parts should be lubricated periodically.

VENTS should be inspected and cleaned annually; lightly oil all moving parts.

VINYL-COATED ceiling and wall panels should be cleaned with a mild soap and damp sponge as needed.

WATER HEATER control compartment should be kept clean and free of combustible material and flammable liquids. The vent and combustion air grille should be clear of any obstructions. Manually operate the pressure temperature relief valve at least once a year. Operate only when storage water in tank is cool. Should overheating occur, or the gas supply fail to shut off, turn off the manual gas control valve to the appliance. Periodically compare main and pilot burner flame with illustrations in the manufacturer's operating instruction manual. Do not tamper with the pilot orifice to increase the pilot flame size; this can cause high water temperature and failure of gas control.

WHEEL BEARINGS should be cleaned and repacked at least once a year.

WOOD CABINETRY should be protected and cleaned several times a year using any good non-silicone wood polish. Careful control of temperature and humidity will help reduce expansion and shrinkage of doors and door panels. If shrinkage

occurs and unfinished parts of the door panels are exposed, cover the exposed areas with matching touchup stain available from your dealer.

APPENDIX A: PRE-TRAVEL CHECK

GENERAL DRIVING CHECKS

For your safety, make certain that the following items have been checked and rechecked before you take your RV on the road. Make certain that all items inside of your RV are secured (e.g., lawn chairs, pots and pans, TV, etc.). As you travel, these items, if not secured, may become damaged or may damage the interior of your unit.

HYDRAULIC LEVELERS — Must be raised as far as possible.

LIGHTS — The following lights should be tested: brake lights, warning lights, flashers, clearance lights, taillights and headlights.

REARVIEW MIRRORS — Adjust the rearview mirrors so that the driver can see the right and left sides of the unit.

OTHER DRIVING CHECKS

Whether you are departing from your home, rest area or campsite, you should check the following parts of your RV before you take off.

TIRES — Before each trip, check your tires for uneven wear, road damage, foreign objects or excessive peeling or bulging. Each morning, inspect the condition and pressure. Heat generated by surface friction will increase the tire's air pressure approximately six to nine psi; therefore, do not bleed air out of a hot tire. Inflate the tire to the recommended pressure (indicated either on the tire or in the manufacturer's instruction booklet).

NOTE: Proper tire inflation is extremely important.

A tire should be replaced when:

1. It is worn to 1/16-inch depth in two or more adjacent grooves.

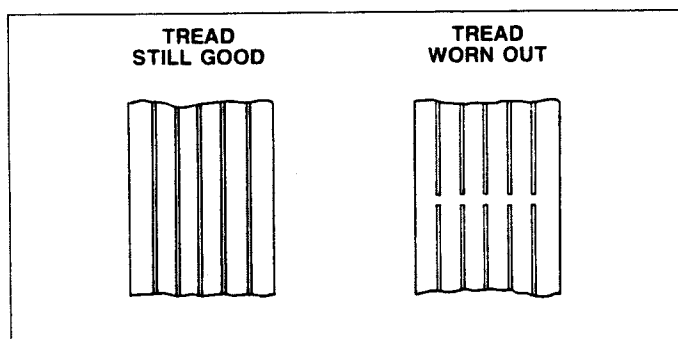

TREAD WEAR INDICATOR

2. It is worn to the level of the tread indicators that are molded into the bottom of the tread grooves, or

3. The indicators appear in two or more adjacent grooves at three locations around the tire.

On new tire purchases, be certain that the new tire is the same size as the old tire and that the new tire has the same ply rating and load range as the old one. **DO NOT** mix radial-ply tires with bias or bias-belted tires.

TIRE CHANGE

Change a tire on as level and firm a surface as possible. If you are on the roadside, activate the vehicle's hazard warning flashers. Apply parking brake and move transmission selector to Park (P). Set up flares and/or warning lights. See the chassis manufacturer's owner's manual for specific jacking and tire removal and replacement instructions which pertain to your unit. Stop at the nearest service facility and have the torque checked.

CAUTION

Never place the jack under a bumper or edge of the sidewall. On units equipped with a tag axle, never place the jack under the tag axle. Use the jack only for changing tires. Never get underneath the vehicle when using the jack; never start or run the engine while vehicle is on the jack. Always securely stow the spare tire on the spare tire carrier and return all jacking equipment to its proper storage area.

WHEEL LUGS — Wheel lugs must be tightened every 50 miles for the first 200 miles whenever a wheel has been reinstalled. Thereafter, check lugs after storage.

POWER CORD — The 120-volt Shoreline power cord must be unplugged from the external source and placed into its compartment. The cord hatch must be secured before you travel.

WATER FILL HOSE(S) — All hoses must be disconnected and all hose caps must be secured before you travel.

SEWAGE TERMINATION VALVES — These valves must be closed and locked before you travel. The sewer hose must be removed from the termination valve outlet and stored in the appropriate compartment. Termination caps must be securely fastened to the termination valve outlet(s).

DOOR STEP — The door step (Figure 18, Page 43) must be returned to its travel position before the unit is safe for traveling. To do this, lift the front edge of the step and push it under the unit.

NOTE: Optional electric steps automatically retract.

WINDOWS AND VENTS — All windows and vents should be closed completely or adjusted as desired before you travel.

APPENDIX B: TRAVEL PREPARATION CHECKLIST

CLOTHING

Underwear
Socks
Shoes, sandals
Shirts
Blouses
Trousers
Slacks
Dresses
Shorts
Sweaters
Jackets
Coats
Rainwear
Swim wear
Pajamas

TOOL CHEST

Screwdrivers
Pliers
Hammers
Tire pressure gauge
Small level
Electrical tape
Masking tape
Wrenches
Furnace duct tape

CAMPSITE COMFORT

Dishwashing soap
Dish cloths
Dish towels
Garbage/trash bags
Mop
Broom
Vacuum cleaner
Dust pan
Paper towels
Foil or plastic wrap
Throw rug

SAFETY

First-aid kit
Flares
Reflectors
Tow rope and/or chain

ADDITIONAL TOOLS

Hatchet
Shovel
Saw
12-volt portable tire pump

SLEEPING GEAR

Sheets
Pillow cases
Mattress pads
Blankets
Pillows
Sleeping bags

PERSONAL COMFORT

Towels
Wash cloths
Toilet paper
Soap
Tooth brush
Tooth paste
Personal toiletries
Scissors
Sewing kit
Ash trays

MEAL PREPARATION

Bottle opener
Can opener
Matches
Pots, pans, skillets
Plates
Glasses and cups
Silverware

MEAL PREPARATION Cont.

Knives, spatula, etc.
Baking pans
Coffee maker
Toaster
Plastic containers

ENTERTAINMENT

Books/magazines
Binoculars
Camera, film, flash
Tape player
Toys/games
Playing cards

MISC. EQUIPMENT

Bucket
Fuses
Fresh water hose
Y-type water hose fitting
Flashlight
20-ft. 3-prong power cord
3-prong adapter with
grounding wire
Wheel chocks, leveling ramp,
blocks or jack stands
Coat hangers
Folding yard chairs

APPENDIX C: TROUBLE SHOOTING

NOTE: Use the manufacturer's owner's manuals for all appliance trouble shooting.

GENERATOR CRANKS BUT WILL NOT START

1. Check the fuel
2. Push RESET button located on the generator
3. Fuse on the generator probably has blown. Replace the fuse with one of the same ampere rating.

FURNACE DOES NOT LIGHT

- ... Check the LP gas supply.
- ... If the furnace does not light after several attempts, do the following:
 1. Turn the thermostat and the furnace gas control valve OFF.
 2. Contact your RV dealer or service center. DO NOT attempt to repair or adjust the furnace yourself.

NOTE: Front grille models are equipped with a manual circuit breaker. If your furnace blower does not come on, reset the circuit breaker by depressing the button. If the problem persists, contact your RV dealer or furnace service center.

WATER PUMP FAILURE OR MALFUNCTION

If the pump fails to start when the switch is ON, check the fuse located in the converter. If the pump continues to operate whether the faucets are opened or closed, check the water tank. It might be empty or there might be a leak in the system. If water pump goes on and off, check all fittings for tightness and all lines for leaks.

WASTE TANK WILL NOT DRAIN

Check for build up in tank at stool. Make sure stool holds water.

NO POWER TO OUTSIDE RECEPTACLE

Check GFI breaker. Check power source.

CONVERTER MAKES CLICKING NOISE

- ... Check circuit for overload.
- ... Check for reversed polarity at battery.
- ... Check for reversed AC polarity.

UNIT HAS ELECTRICALLY CHARGED (HOT) CHASSIS

- ... Disconnect unit from electrical supply.
- ... Have unit inspected and repaired, if necessary, by a qualified service facility.

NOTE: Determine if Shoreline supply has proper polarity.

RV BATTERY BOILING

- ... Water low in battery
- ... Bad battery
- ... Defective battery charger in Power Center.

LIGHTS FLICKERING

Check to see if the following could be causing the problem: loose fuse holders, broken fuse, broken connection or wire, bad ground.

LIGHTS DIM OR HALF BRIGHT

Check battery condition. Possible converter malfunction. Possible low voltage from Shoreline.

SMELL GAS

1. Extinguish any open flames, pilot lights and all smoking materials.
2. Do not touch electrical switches.
3. Shut off the gas supply at the tank valve(s) or gas supply connection.
4. Open doors and other ventilating openings.
5. Leave the area until odor clears.
6. Have the gas system checked and leakage source corrected before using again.

NO POWER TO UNIT

- ... Check Shoreline. Make sure you have power to the Shoreline.
- ... Check the converter; the breaker switches might be off or tripped.

REFRIGERATOR WILL NOT COOL

Make sure unit is level. Check that lower and upper refrigerator vents are clear. If on gas, check gas supply.

MICROWAVE OVEN WILL NOT OPERATE

Check power to oven. Check to see that the timer is ON and door is closed.

TV ANTENNA HAS POOR RECEPTION

- ... Check connections at TV and wall plate.
- ... Make sure cable is in good condition at TV and antenna (not cut or nicked).
- ... Check antenna to ensure that it is pointed in the direction of the "sending" station.
- ... Check TV on another system known to work.

NO RUNNING LIGHTS

- ... Check fuse.
- ... Check bulbs.

TERMINATION VALVE LEAKS

- ... Check blade inside valve to see that it is clear.
- ... Check gasket at termination cap.

MAINTENANCE RECORD

DATE	MILEAGE	SERVICE SHOP NAME & ADDRESS	DESCRIPTION OF SERVICE

If you believe that your vehicle has a defect which could cause a crash or could cause injury or death, you should immediately inform the National Highway Traffic Safety Administration (NHTSA) in addition to notifying Shasta Industries.

If NHTSA receives similar complaints, it may open an investigation, and if it finds that a safety defect exists in a group of vehicles, it may order a recall and remedy campaign. However, NHTSA cannot become involved in individual problems between you, your dealer, or Shasta Industries.

To contact NHTSA, you may either call the Auto Safety Hotline toll-free at 1-800-424-9393 (or 366-0123 in Washington, D.C. area) or write to: NHTSA, U.S. Department of Transportation, Washington D.C. 20590. You can also obtain other information about motor vehicle safety from the Hotline.

MAINTENANCE SCHEDULE *

ITEM							REFERENCE
	Every Trip	Every 30 days or 1,000 miles	Every 60 days	Every 90 days or 2,500 miles	Every 6 months or 5,000 miles	Annually or 10,000 miles	
Airing	X						Air Quality, Condensation, Maintenance, this manual
Appliances	X					X	Appliances, this manual; Appliance Manufacturers' instructions
Awning Rails						X	Maintenance, this manual
Automotive System	X						Chassis Manufacturer's manual
Batteries	X	X					Maintenance, this manual
Brakes					X	X	Maintenance, this manual; Brake Manufacturer's manual
Body					X		Maintenance, this manual
Bumpers						X	Maintenance, this manual
Counter, Table Tops	X						Maintenance, this manual
Doors				X			Maintenance, this manual
Electrical System	X						Maintenance, this manual
Fabrics						X	Care of Fabrics, this manual
Floor Coverings	X						Maintenance, this manual
Frame						X	Maintenance, this manual
Hinges						X	Maintenance, this manual
Locks & Latches						X	Maintenance, this manual; Lock/Latch Manufacturer's manual
LP Gas	X	X					LP Gas, this manual; Appliance Manufacturers' instructions
Lug Nuts	X						Maintenance, this manual
Roof, Body, Underbelly				X			Maintenance, this manual
Seams (Seal)						X	Maintenance, this manual
Shades, Valances	X						Maintenance, this manual
Steps	X					X	Maintenance, this manual; Step Manufacturer's instructions
Tires	X					X	Pre-Travel Check, Maintenance, this manual; Tire Mfg's instructions
TV Antenna		X					TV Antenna Manufacturer's instructions
Vents						X	Maintenance, this manual; Vent Manufacturer's instructions
Vinyl Ceiling & Wall Panels	X						Maintenance, this manual
Water Heater	X					X	Maintenance, this manual; Water Heater Manufacturer's instructions
Wheel Bearings						X	Maintenance, this manual; Axle Manufacturer's instructions
Windows	X						Maintenance, this manual; Window Manufacturer's instructions
Wood Cabinetry	X		X				Maintenance, this manual

* Maintenance schedules listed are minimum requirements; heavy use, unusual temperatures or humidity, or other environmental conditions may require more frequent maintenance.

APPLIANCE IDENTIFICATION FORM

Should your unit or one of the appliances require warranty service, you will have to identify the manufacturer, model designator and serial number. Fill in this form as soon as possible. It will help you meet our identification requirement. Depending on your unit, certain items listed below may not be offered as either optional and/or standard. Most of this information can be found on the Recreational Vehicle Data Card attached to the inside of one of the kitchen cabinets.

EQUIPMENT	MANUFACTURER	MODEL DESIGNATOR	SERIAL NUMBER
Automotive Air Conditioner	_____	_____	_____
Converter	_____	_____	_____
Electric Water Pump	_____	_____	_____
Furnace	_____	_____	_____
Furnace	_____	_____	_____
Generator	_____	_____	_____
Ice Maker	_____	_____	_____
Keys — Door	_____	_____	_____
Exterior Storage	_____	_____	_____
Other	_____	_____	_____
Microwave Oven	_____	_____	_____
Motorhome Body	_____	_____	_____
Motorhome Chassis	_____	_____	_____
Radio	_____	_____	_____
Range/Oven	_____	_____	_____
Refrigerator	_____	_____	_____
Roof Air Conditioner(s)	_____	_____	_____
Toilet	_____	_____	_____
TV	_____	_____	_____
TV Antenna	_____	_____	_____
VCR	_____	_____	_____
Water Heater	_____	_____	_____

ELECTRICAL SPECIFICATIONS

FUSES

Interior — 15 amp., 12 VDC

LIGHT BULBS

Interior 12 VDC (Except dome light inside driver compartment and new SC ceiling light bulbs #1003 and wall fixture light bulbs #1076)

Range Hood

— 1141

Turn, Tail and Stop

— 25 Watts (12 VDC)

Backup

— 1157

License Plate

— 1156

Clearance

— 67

Patio

— 57

Fluorescent Light Tube

— 1003

— F15TB-CW

MISCELLANEOUS — See the brochure for the exterior dimensions, weight ratings and wheel/tire ratings which pertain to your unit.

SHASTA MINI MOTORHOME

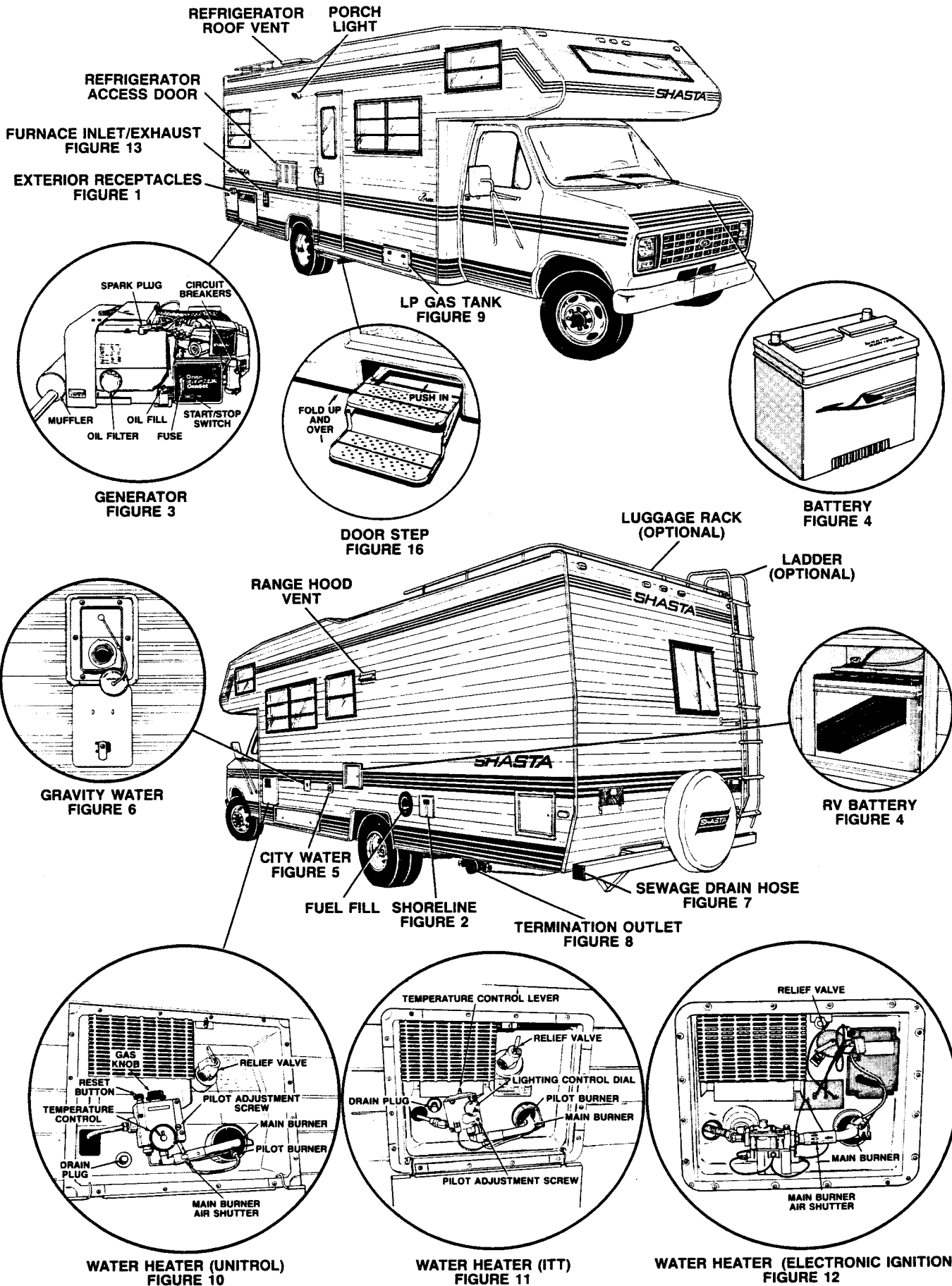

SHASTA MB/BH MOTORHOME

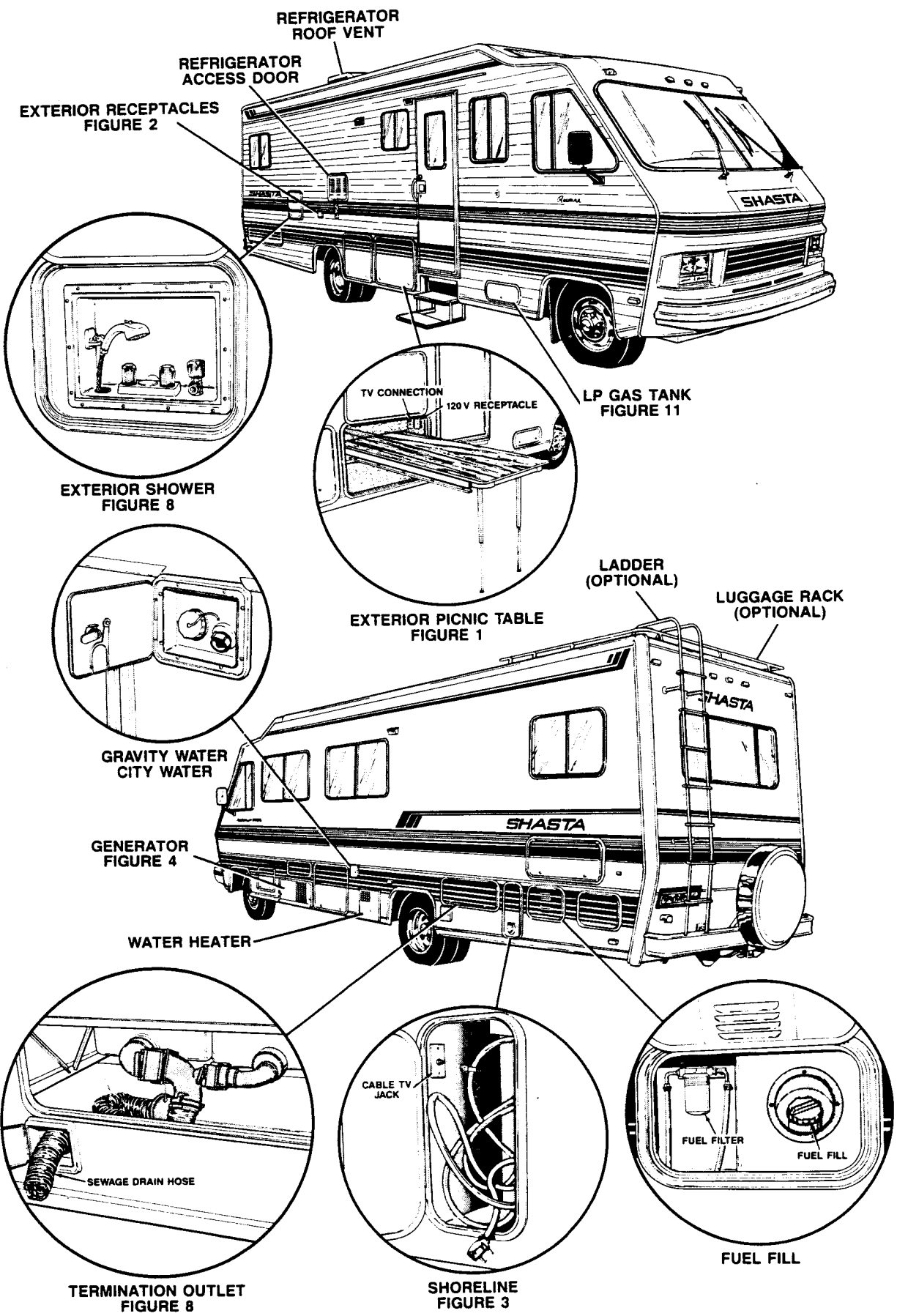

SHASTA CLASS A MOTORHOME

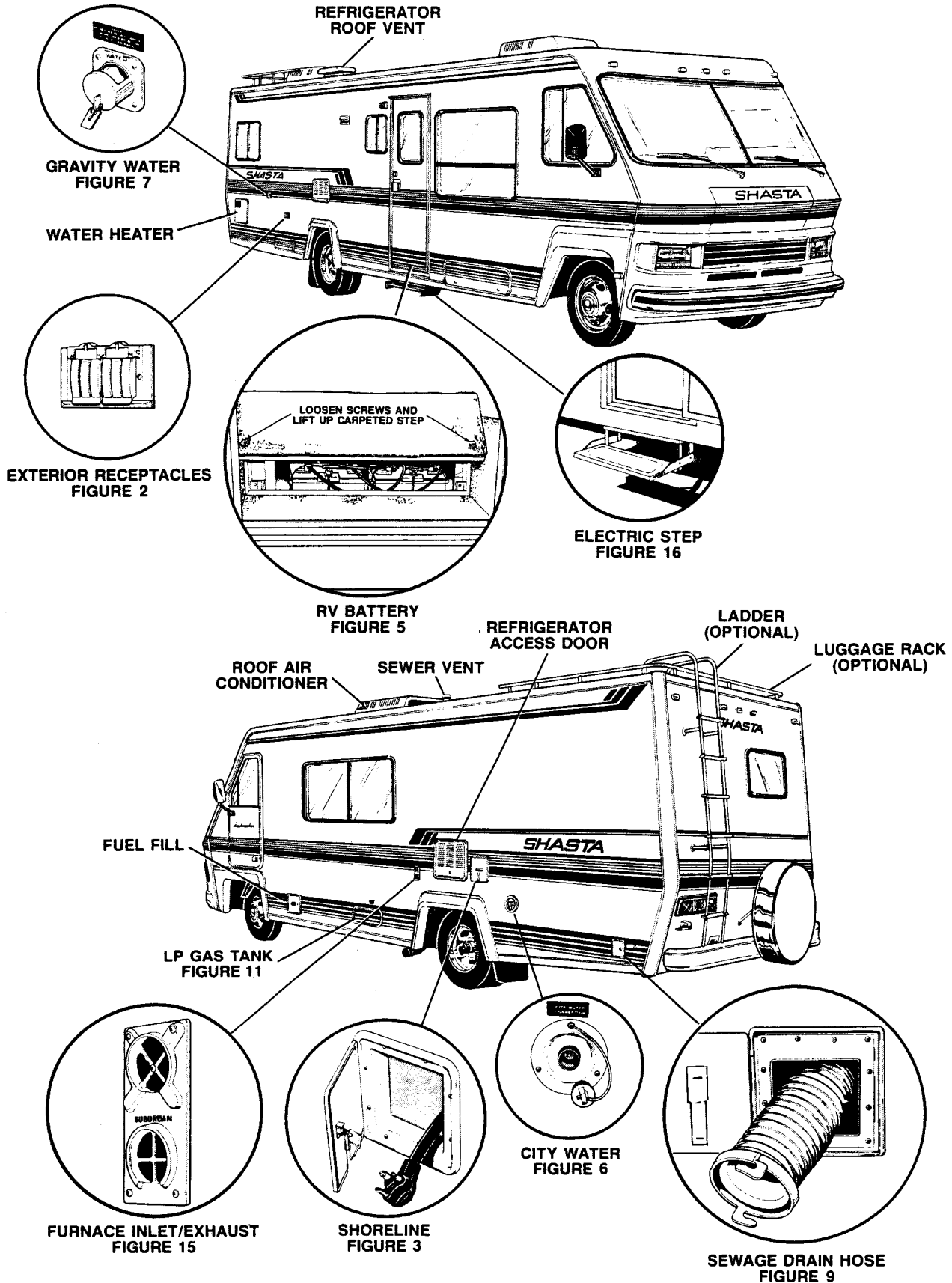

VEHICLES SHOWN ARE FOR ILLUSTRATION PURPOSES ONLY: SOME ITEMS SHOWN ARE NOT AVAILABLE ON CERTAIN MODELS AND MAY BE OPTIONAL ON OTHERS.



YOU'VE CHOSEN SHASTA ALL-AROUND VALUE!

As a new Shasta owner, you've made a sensible choice among recreational vehicles. Your Shasta is built with care and craftsmanship, and your choice of Shasta is backed by . . .

- Coachmen Industries, Inc., the world's largest full-line manufacturer of recreational vehicles.
- A coast-to-coast network of happy-to-serve-you dealers.
- Shasta's famous customer service. Your Owner Registration Card is your ticket to fast, dependable, one-stop service, nationwide and in Canada.
- The International Wings Of Shasta Owner's Club, to bring you the most pleasure in owning an RV.
- Traditional high trade-in value for any recreational vehicle built by Shasta!

SHASTA — Quality RVs Since 1941.

SHASTA

AMERICA'S SECOND HOME
Quality Recreational Vehicles Since 1941

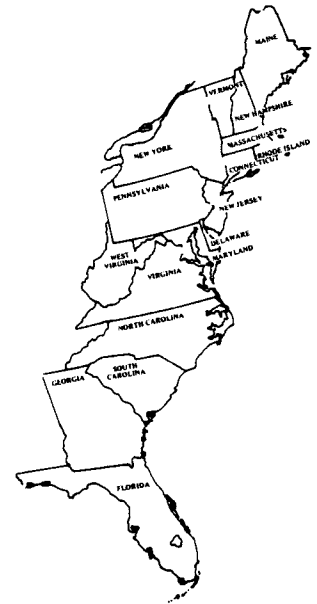

Shasta of Indiana
14489 US 20
P.O. Box 631
Middlebury, In 46540
(219) 825-8555
800 233-5571