

2000



PURSUIT

OWNER'S MANUAL

MOTOR HOMES BY ...
GEORGIE BOY MANUFACTURING, INC.

69950 M-62 • EDWARDSBURG, MICHIGAN 49112 • PHONE (616) 663-3415

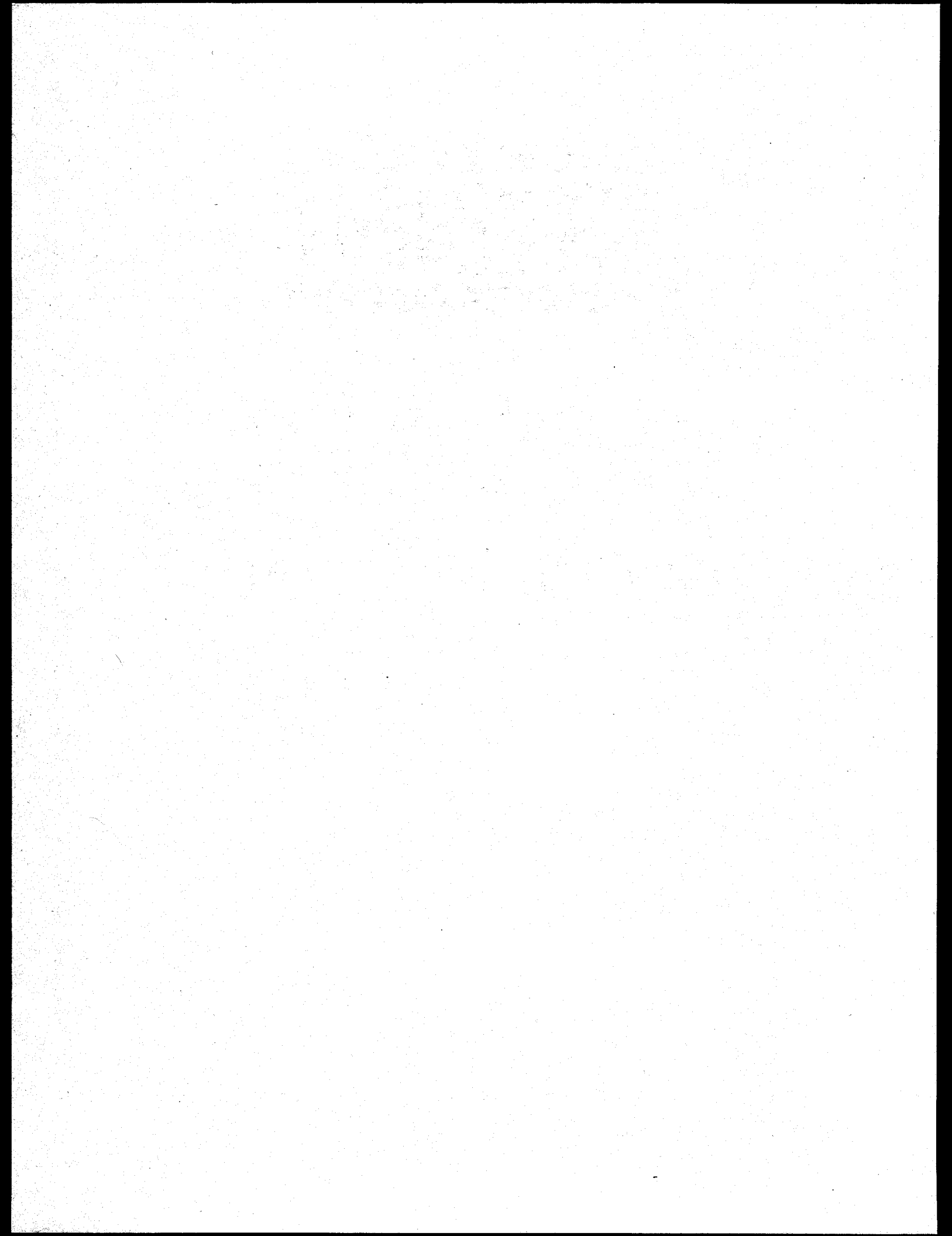

Welcome

Welcome to the recreational vehicle lifestyle! This manual describes the many features of your recreational vehicle and gives a few simple steps relating to use or maintenance. Use these suggestions to help assure your family of years of carefree pleasant traveling, or vacationing.

Your dealer's Service or Sales Department will promptly handle any normal problem which might occur. Customer service is of utmost importance to your dealer and is just as important to us, the manufacturer.

Reference Material

Keep this Owner's Manual, the Chassis Operator's Manual, and your Owner's Information Kit of Component and Accessory Manuals in a convenient place in your motor home.

Motor Homes

The Pursuit motor home is covered in this manual. The Pursuit is offered on either a Workhorse, Ford or Chevrolet chassis.

Table of Contents

Page Contents

| | |
|-------|------------------------------------|
| 2 | Construction Standards |
| 2 | Vehicle Load Capacity and Weighing |
| 4 | Exterior Features |
| 5 | Planning and Preparation |
| 6 | Getting Ready to Leave |
| 7 | On the Road |
| 9 | Maintenance of Power Systems |
| 11 | Electrical Systems |
| 13-16 | Electrical Diagrams |
| 17 | Liquid Petroleum Gas System |
| 21 | Plumbing Systems |
| 24 | Component Monitoring System |
| 24 | Equipment and Furnishings |
| 25 | Care and Maintenance |
| 27 | Extended Storage |
| 28 | Emergencies |
| 30 | Service |
| 30 | Reporting Safety Defects |
| | Index |

Forward

This manual describes the various design features and operating procedures of your motor home to aid you in understanding its capabilities.

Like all fine equipment, your motor home will require care and regular maintenance in order to retain its maximum performance characteristics. This manual, along with the Chassis Operator's Manual and the information from other component manufacturers provided for your use, defines the important areas of maintenance you will want to follow. The time spent reading and understanding these instructions will result in your having a good working knowledge of the unit. Knowing how to use your motor home and how to keep it properly maintained will help you enjoy thousands of miles of motoring pleasure.

All of the information in this Manual is important. However, statements preceded by the words **Warning, Caution and Note** are especially important. Heed them carefully.

WARNING STATEMENTS CONTAIN INFORMATION THAT IS IMPORTANT FOR YOUR SAFETY AND THE SAFETY OF YOUR PASSENGERS.

Caution statements contain information that is important to the protection of your property.

Note statements contain information that is important to remember, but not necessarily safety related.

The information presented in the Manual is intended to be as comprehensive as possible. However, your motor home may differ in some ways from the photographs, illustrations and information presented. **Likewise, production components are subject to change without notice and without obligation by the manufacturer.** If you have questions regarding your specific motor home, contact your dealer or call the service department at Georgie Boy Mfg., Inc. Please refer to the Georgie Boy Mfg. serial number which is stamped on a metal tag under the hood and printed on the vehicle information sticker near the driver's side front window.

Construction Standards

It is our intention and utmost goal to provide a safe and quality built motor home to each and every purchaser. To this end, we have strived to build all our units to the most stringent requirements of all Codes and Standards which cover the production of motor homes. In some cases, those requirements are inconsistent and we have chosen the standard which meets the legal requirements for the State in which it is delivered. We are confident the purchasers of our products have received motor homes that will meet their recreational requirements with the optimum safety, quality and design.

Note: Any alterations or additions, or results of those alterations or additions to the finished product as shipped by Georgie Boy, are the responsibility of the party making the alterations or additions, and not Georgie Boy Mfg., Inc.

Certifications of construction standards by the primary vehicle manufacturer are the responsibility of that manufacturer and are not assumed by Georgie Boy Mfg., Inc.

Your motor home has been designed to conform with or exceed the American National Standards Institute Code A119.2 and/or State and Federal motor vehicle standards as applicable. These Standards establish the plumbing, heating, electrical and other requirements for quality and safety. Compliance with this Standard is indicated by the seal installed just outside the passenger entrance door. This seal is the outward sign of internal quality.

Should you have any questions regarding operation, maintenance or service, please contact your dealer immediately so he can be of assistance.

Vehicle Load Capacity and Weighing

Your motor home is designed to carry the loads defined by the Gross Axle Weight Rating (GAWR - the value specified by the chassis manufacturer as the load carrying capacity of a single axle system, as measured at the tire/ground interface.) Gross Vehicle Weight Rating (GVWR - the maximum permissible loaded

weight of the motor home) shown on the vehicle information sticker posted near the driver's side front window. These ratings are for a fully-loaded vehicle including passengers and normal belongings.

| | | | |
|---|-------------------------------------|------|-----------------|
| MFD. BY: | GEORGIE BOY MFG. INC. | | |
| | EDWARDSBURG, MI 49112 | | |
| DATE OF MFR. | MAY 1999 | | |
| INC. VEH. MFD. BY: | CHEVROLET | | |
| DATE OF INC. MFG. | APRIL 1999 | | |
| G.V.W.R. | 14,800 | | |
| G.A.W.R. FRONT | 5500 | WITH | 7.5X16D |
| TIRES, | 16X6K | | RIMS, AT |
| | 65 | | PSI COLD SINGLE |
| REAR | 10000 | WITH | 7.5X16D |
| TIRES, | 16X6K | | RIMS, AT |
| | 60 | | PSI COLD |
| THIS VEHICLE CONFORMS TO ALL APPLICABLE FEDERAL MOTOR VEHICLE SAFETY STANDARDS IN EFFECT ON | | | |
| 04/99 | | | |
| V.I.N. | 1GBKP37J4X3303672/5BCA0311XYF074185 | | |
| TYPE: | MULTI PURPOSE PASSENGER VEHICLE | | |

WARNING: EXCEEDING THE GAWR OR GVWR OF YOUR MOTOR HOME CAN CAUSE UNDESIRABLE HANDLING CHARACTERISTICS AND MAY EVEN CREATE A SAFETY HAZARD. MODIFICATION OF YOUR VEHICLE BY ADDITION OF RACKS NOT SPECIFIED BY THE MANUFACTURER TO CARRY ADDITIONAL EQUIPMENT OR VEHICLES IS NOT RECOMMENDED AND MAY MAKE YOUR WARRANTY INAPPLICABLE.

Note: Be sure the weight of passengers, equipment and supplies does not cause your motor home to exceed axle loads and overall vehicle loads for which it was designed. If in doubt, weigh the vehicle at a public scale. Keep in mind the number of safety belts in a unit are there for the convenience of selection of use by the owner and not meant to imply that you can carry an amount of people and their cargo equal to the number of seat belts and not exceed the weight ratings. A motor home, as well as other vehicles, has the potential to be overloaded and removal or redistribution of weight may be necessary from time to time to stay within the weight ratings.

Your motor home includes a "Weight Information Label." This label provides specific weight information for your motor home as a guideline for you to determine the load carrying capabilities to safely operate your motor home. This label will be located inside the wardrobe.

Georgie Boy motor homes are designed to allow for a wide variety of uses, extended trips with two people or short trips with multiple people. Accordingly, each unit allows ample room for sleeping, seating, fluids and cargo. While the customer is the beneficiary of this design, the customer also bears the responsibility to select the proper combination of passengers, cargo load, and towed vehicle without exceeding the chassis weight capabilities.

Seat belts are required to be worn in most states, and should always be worn for passenger safety. Seat belts are provided at most locations to allow convenience in selecting which seat to occupy. However, it is not intended that all seating positions equipped with a seat belt may be occupied while the vehicle is in motion, without regard to other weight factors.

SAMPLE

DO NOT EXCEED THE NET CARRYING CAPACITY OF THIS VEHICLE

PRODUCT PURSUIT YEAR 2000 MODEL 2905 SER# (GEORGIE BOY UNIT #)

14800 LBS. GVWR **GROSS VEHICLE WEIGHT RATING** MEANS THE MAXIMUM PERMISSIBLE WEIGHT OF THIS MOTOR HOME. THE GVWR IS EQUAL TO OR GREATER THAN THE SUM OF THE UNLOADED VEHICLE WEIGHT PLUS THE NET CARRYING CAPACITY.

12086 LBS. UVW **UNLOADED VEHICLE WEIGHT** MEANS THE WEIGHT OF THIS MOTOR HOME AS BUILT AT THE FACTORY WITH FULL FUEL, ENGINE OIL AND COOLANTS, THE UVW DOES NOT INCLUDE CARGO, FRESH WATER, LP GAS, OCCUPANTS, OR DEALER INSTALLED ACCESSORIES.

2714 LBS. NCC **NET CARRYING CAPACITY** MEANS THE MAXIMUM WEIGHT OF ALL OCCUPANTS INCLUDING THE DRIVER, PERSONAL BELONGINGS, FOOD, FRESH WATER, LP GAS, TOOLS, TONGUE WEIGHT OF TOWED VEHICLE, DEALER INSTALLED ACCESSORIES, ETC., THAT CAN BE CARRIED BY THIS MOTOR HOME. (NCC IS EQUAL TO OR LESS THAN GVWR MINUS UVW).

19000 LBS. GCWR **GROSS COMBINATION WEIGHT RATING** MEANS THE VALUE SPECIFIED BY THE MOTOR HOME MANUFACTURER AS THE MAXIMUM ALLOWABLE LOADED WEIGHT OF THIS MOTOR HOME WITH ITS TOWED TRAILER OR TOWED VEHICLE. THE ACTUAL GCWR OF THIS VEHICLE MAY BE LIMITED BY THE SUM OF GVWR OF THIS VEHICLE PLUS THE HITCH RATING CAPACITY. SEE HITCH RATING LABEL FOR WEIGHT LIMITATIONS.

THE MOTOR HOME IS CAPABLE OF CARRYING UP TO 63 GALLONS OF FRESH WATER (INCLUDING WATER HEATER) FOR A TOTAL OF 525 POUNDS. REFERENCE: WEIGHT OF FRESH WATER IS 8.33 LBS. / GAL.

All Georgie Boy motor homes are designed to ensure that the number of passengers allowed while the vehicle is in motion will always at least equal the stated sleeping capacity. Though extra seat belts may be provided, for your safety and the proper operation of your vehicle, limit your passengers to the number allowed by the Net Carrying Capacity of your vehicle.

Note: Each motor home must have as many "designated seating positions" (DSP's) as it has Stated Sleeping Positions. A DSP is one equipped with a seat belt that complies with all pertinent FMVSS requirements. The following guidelines should be used for determining your stated sleeping positions:

Sleeping Surface

Double or Queen Bed
Twin Bed, each
Jack-Knife Sofa
Hide-A-Bed Sofa
Convertible Dinette

Sleeping Capacity

2
1
1
2
1

Make sure that all cargo is properly distributed side to side and front to rear prior to weighing. Also note the level of fuel, water and LP at the time of weighing. **Note:** Each trunk compartment maximum capacity is 200 lbs.

Periodically weigh the motor home at a public scale to determine axle loads. The following procedure is suggested, although any method recommended by the scale operator which correctly determines weight values is acceptable. During all measurements, it is important that the vehicle be kept as level as possible.

1. Run only the front wheels onto the scale platform and obtain a reading. (This first value is the front axle Gross Axle Weight.)
2. Next, place the entire vehicle (all axles) on the scale and obtain a reading. (This second value is Gross Vehicle Weight.)
3. Drive forward until only the rear axle is on the platform and obtain a reading. (This third reading is rear axle Gross Axle Weight.)
4. Compare reading 2 with GVWR of your vehicle. If this reading exceeds the GVWR rating, it will be necessary to reduce total vehicle load.
5. If reading 2 is less than the GVWR of your vehicle, check readings 1 and 3 to verify that each is less than the GAWR on the certification tag. If either exceeds the GAWR for the axle, redistribute enough equipment from front to back or the reverse to ensure that loads on front and rear axles are within the required limit.

Note: Additional cargo carrying capacity can be obtained by reducing the amount of fresh water carried while driving.

Check vehicle weight periodically to obtain optimum mileage from tires and improved handling. Tires should always be inflated as recommended in the Chassis Manufacturer's Instructions, or on the tire sidewall. See your Chassis Operator's Manual.

Exterior Features Pursuit

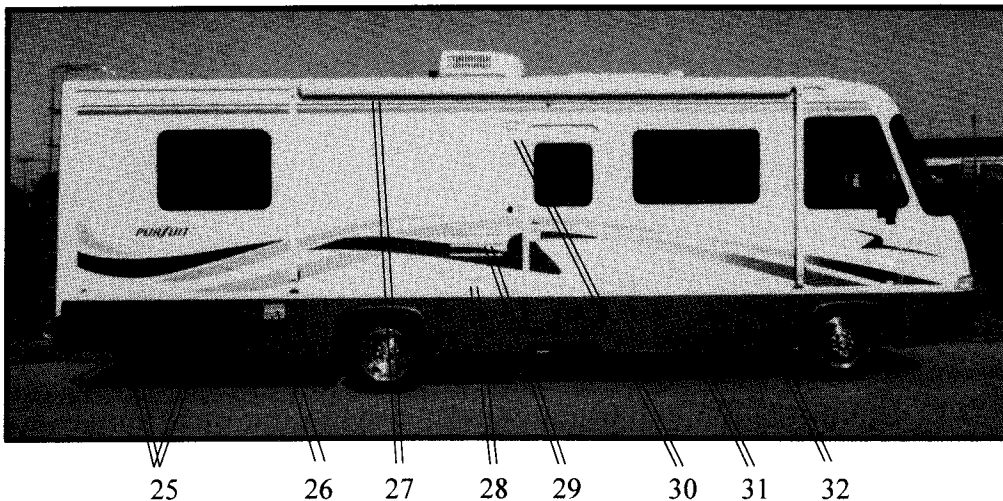
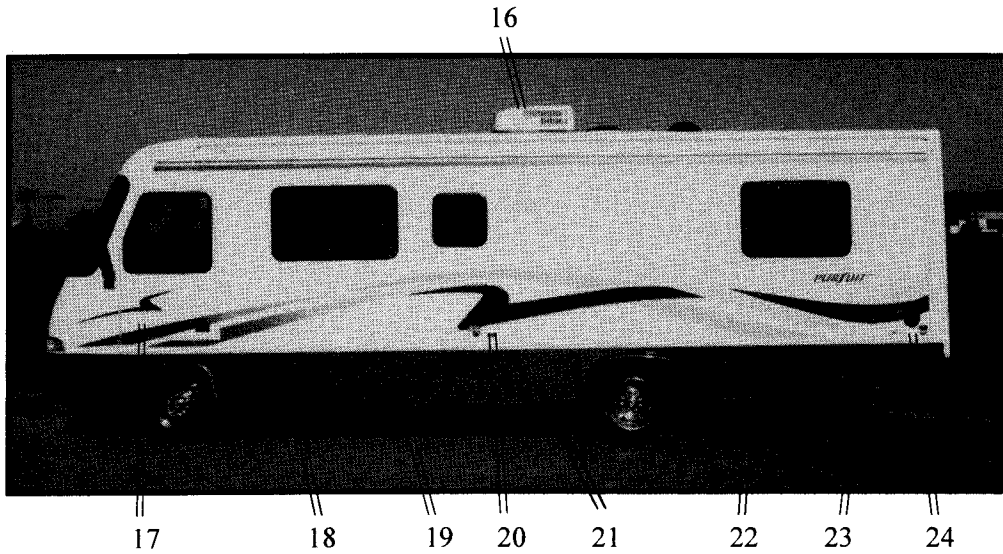

1. Windshield Wipers
2. Front Running Lights
3. Rearview Mirrors
4. Headlights
5. Main Engine Battery
6. Engine Access Door
7. License Plate Holder
8. Turn Signals and Emergency Flasher Lights
9. Rear Running Lights
10. Ladder
11. Tail, Brake, Turn, Back-up and Flasher Lights
12. License Plate Holder
13. Trailer Hitch
14. Storage Compartment
15. Center Brake Light
16. Roof Air Conditioners
17. Driver's Door
18. Storage Compartments
19. Storage Compartment
20. Furnace Vent
21. Plumbing Compartment
22. Generator Compartment
23. Electrical Compartment
24. Fuel Fill
25. Storage Compartments
26. Water Heater
27. Awning
28. Patio Receptacle
29. Refrigerator Vent
30. Patio Light
31. LP Gas Compartment
32. Storage Compartment

Planning and Preparation

Plan your trip and organize all preparations before you leave. Proper preparation can be the key to getting the most enjoyment from your motor home.

The following suggestions are provided only as a guide. Review them carefully before starting on your first trip. Refer to the list when on trips and make note of items forgotten to make subsequent trips even more enjoyable.

1. Plan your route carefully. Consult maps and guidebooks (available at most bookstores and newsstands) to become aware beforehand of any road conditions, campsite availability and other circumstances.
2. Be sure your batteries are fully charged and that all equipment is serviced and ready for travel.
3. Check all fluids including:
 - Motor home engine crankcase oil
 - Transmission fluid
 - Power steering fluid
 - Radiator recovery system reservoir level
 - Master cylinder brake fluid
 - For diesel units refer to the Chassis Operator's Manual for possible water and air filter maintenance
 - Windshield washer reservoir level
 - Hydraulic leveling jack reservoir, if so equipped
4. Inspect wheel lugs for tightness. Examine all tires for road damage and wear, then inflate to the proper pressures as recommended in the Chassis Operator's Manual.

Note: Tire pressures listed in your Chassis Operator's Manual are for cold tires and normal driving and load conditions and also for unusual operating or load conditions. Use the appropriate pressure for your driving conditions.

5. Check oil level in the generator power plant (if installed.) Refer to instructions and maintenance manual provided by the generator manufacturer for other pre-use service requirements applicable to this equipment. Check that extra oil and other service supplies are provided for the generator power plant if the motor home is to be used for extended periods.

6. Make sure that a serviceable fire extinguisher is secured in the mounting bracket.
7. Verify that all items you plan to take are on board.
8. Check that accessories, such as a plastic sewer hose with the necessary fittings and a water supply line, such as an approved water hose for 125 psi, are on board.

Note: It may be desirable to check ahead with specific campsites where you plan to stop for any special adapters which may be required.

9. Fill fresh water tank, if required. (Refer to the Plumbing Section.)
10. Make sure that drain line cap and holding tank knife valves are closed and secured. Add a holding tank chemical to a few gallons of water in your body waste holding tank. (Refer to Plumbing Section.)
11. Check brake lights, all running lights, turn signals and other vehicle safety items.
12. Put motor home contents in "travel" condition.
13. Secure any loose objects which could shift while traveling.
14. Secure refrigerator contents (place lids on all containers holding liquids, for example) then secure locking latch on refrigerator door.
15. Be sure all cabinets have the contents secured.
16. Fill the fuel tank and be careful not to overfill. Your motor home is designed to use only the fuel recommended in the Chassis Operator's Manual.
17. Be sure all exterior doors are closed and locked.
18. Adjust the driver's seat to the most comfortable position, then adjust the side view mirrors for maximum visibility.

WARNING: ALL PILOT LIGHTS, APPLIANCES AND THEIR IGNITORS (SEE OPERATING INSTRUCTIONS) SHALL BE TURNED OFF DURING REFUELING OF MOTOR FUEL TANKS AND/OR LP-GAS CONTAINERS.

WARNING: PORTABLE FUEL-BURNING EQUIPMENT, INCLUDING WOOD AND CHARCOAL GRILLS AND STOVES, SHALL NOT BE USED INSIDE THE RECREATIONAL VEHICLE. THE USE OF THIS EQUIPMENT INSIDE THE RECREATIONAL VEHICLE MAY CAUSE FIRES OR ASPHYXIATION.

WARNING: DO NOT BRING OR STORE LP-GAS CONTAINERS, GASOLINE OR OTHER FLAMMABLE LIQUIDS INSIDE THE VEHICLE BECAUSE A FIRE OR EXPLOSION MAY RESULT.

Getting Ready to Leave

Note: Each person riding in or driving the motor home should be familiar with preparation and operation procedure and check lists. Your time on the road will be safer and more enjoyable if all persons are able to contribute; and that knowledge may be invaluable in case of an emergency.

The following suggestions may be helpful when you are getting ready to leave.

Starting and Warm-up

For best results, always follow the recommendations in your Chassis Operator's Manual when starting or operating your engine.

Note: Be sure the transmission is in PARK and the parking brake is engaged to keep the motor home from rolling. If the parking brake needs adjustment, see the Chassis Operator's Manual for proper adjustment instructions.

Safety Belts

Safety belts are an important safety feature of your vehicle. For your protection, it is required that all belts be fastened while your motor home is in motion. The driver's seat and other seats have been equipped with safety belts.

WARNING: SOME SEATS IN SOME MOTOR HOMES MAY NOT HAVE A SAFETY BELT PROVIDED. THESE SEATS ARE NOT INTENDED FOR USE WHILE THE VEHICLE IS IN MOTION. USE THEM FOR ADDITIONAL SEATING ONLY WHEN THE VEHICLE IS STATIONARY. THESE SEATS ARE DESIGNATED BY A TAG NEAR THE SEAT.

Safety belts on the driver's seat and the front passenger seat are retractable and self-adjusting.

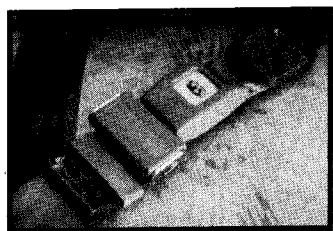

Simply make sure the belt is not twisted when coupling. The other safety belts are adjusted in the following manner: To lengthen the belt, tip the buckle at right angles to the belt. Holding the buckle in this position permits the belt to slide through. Pull on the buckle until the desired length is obtained. To fasten the belts, make

sure the belts are not twisted, then push the tongue end of one belt into the buckle of the mating belt. Be sure it goes in all the way and that it latches. Tighten by pulling the loose end of the belt while holding the buckle. Adjust the belt as low on the abdomen and as snug as comfort will allow for greatest safety. NEVER USE A BELT FOR MORE THAN ONE PERSON. Consult your Chassis Operator's Manual for information concerning drivers and passengers seat belts.

Important Child Restraint Precautions

You are required by law to use safety restraints for children in the U.S. and Canada. If small children ride in your recreation vehicle (generally children who are four years or younger and who weigh 18 kg (40 lbs.) or less, you must put them in safety seats made especially for children. Check your local and state or provincial laws for specific requirements regarding the safety of children in your vehicle.

Always follow the instructions and warnings that come with any infant or child restraining seats you might put in your vehicle. If you do not install and use the safety seat properly, the child may be injured in a sudden stop or collision.

Rear facing child seats or infant carriers should never be placed in the front seats. If your unit is equipped with passenger seat airbags, do not allow small children to ride in the passenger seat. Most child seats do not have side impact protection and therefore may not be used at any location facing sideways.

Children who are not too large for child safety seats (as specified by your child safety manufacturer) should always wear safety belts. Failure to do so may increase the risk of injury in a collision.

Follow all the important safety restraint and air bag precautions that apply to adult passengers in your vehicle.

Never let a passenger hold a child on his or her lap while the vehicle is moving. The passenger cannot protect the child from injury in a collision.

Electrical

Test your interior lights, electrical appliances and automotive lights and accessories. Check for spare fuses of every size used in the vehicle.

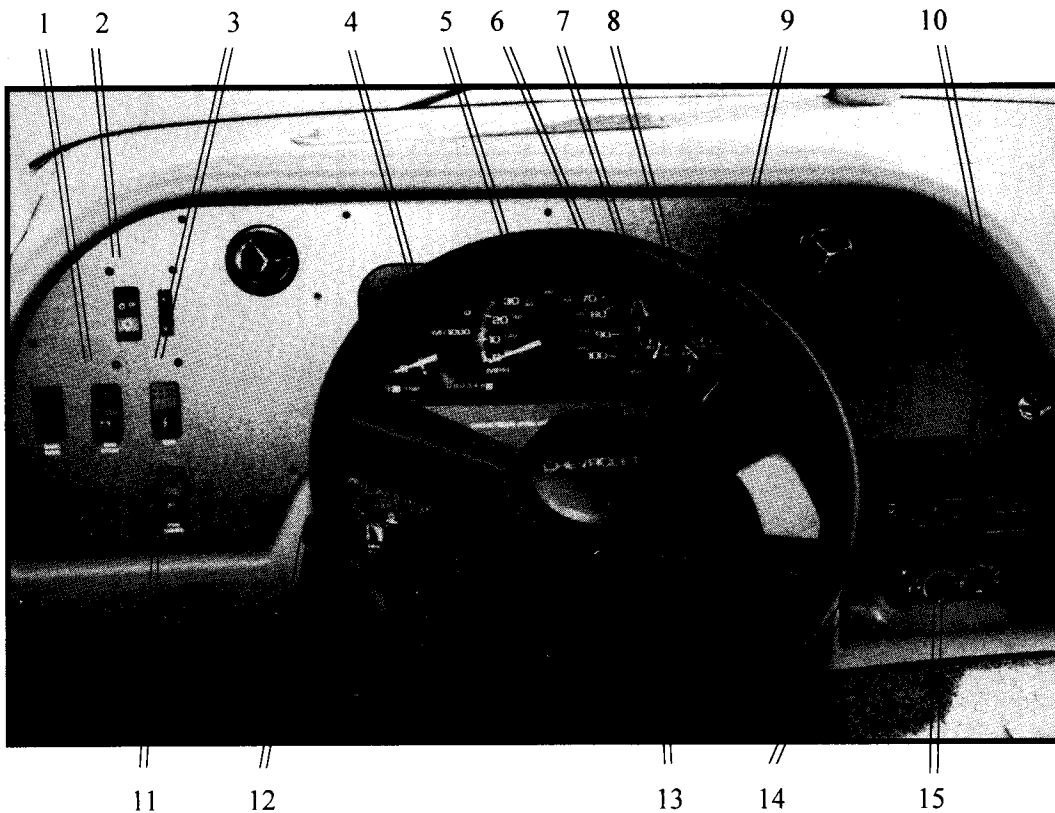

Pursuit Driver's Compartment (Chevy)

1. Emergency Start Switch
2. Light Switch & Dimmer
3. Generator Switch
4. Tachometer
5. Speedometer Gauge
6. Oil Pressure Gauge
7. Fuel Gauge
8. Volt Meter
9. Temperature Gauge
10. Cigarette Lighter
11. Fog Lights Switch
12. Windshield Wiper &
Turn Signal Control
13. Ignition Switch
14. AM/FM Radio w/Cassette
15. Heater/Air
Conditioner Control

Fuel (Liquid Petroleum, Gasoline, Diesel)

The Landau runs on unleaded gasoline or diesel fuel. Liquid propane (LP) gas is required to operate the range, oven, water heater and furnace. The refrigerator may be powered by either LP gas or electricity.

A generator is an optional feature. On a gasoline-powered motor home, the generator runs on gasoline from the same automotive fuel tank that supplies the engine. On a diesel powered unit, you will have a generator that runs on LP gas.

Before starting a trip, fill all the fuel tanks with the appropriate fuel.

Caution: Do not overfill the fuel tank. Overfilling can cause excessive pressure and poor engine performance. Stop filling the tank the first time that the automatic nozzle on the gas hose shuts off.

WARNING: LP GAS, DIESEL AND GASOLINE ARE EXPLOSIVE. READ AND HEED THE WARNING LABELS ATTACHED TO THE LP GAS TANK AND THE MOTOR HOME NEAR THE FUEL FILLER PIPE.

WARNING: BEFORE FILLING THE LP GAS TANK OR FUEL TANK, EXTINGUISH ALL PILOT LIGHTS AND OPEN FLAMES ON APPLIANCES; AND, OF COURSE, EXTINGUISH ALL MATCHES AND SMOKING MATERIALS.

Note: For your convenience many, or all, appliances manufactured into a Georgie Boy motor home are equipped with automatic electronic ignition rather than pilot lights.

Caution: Since supplier components change from time to time, or accessory appliances may have been added to your motor home after manufacture, do not assume that is the case on all appliances. Learn which appliances have pilot lights and heed the above warning.

Driver's Compartment

Take the time before leaving to become familiar with the location and operation of the instrument control panel and other items in the driver's compartment.

Make sure that all automotive accessories and indicator lights are working. Refer to the Chassis Operator's Manual for information regarding components which are installed by the chassis manufacturer. Be comfortable behind the wheel. Adjust the seat and tilt steering wheel. After doing so, make sure the mirrors are aligned for maximum rear visibility. Readjust all of these for different drivers, if necessary.

On the Road

Driving and Parking

Driving the motor home is comparable to driving your family car, once you become accustomed to the feel of the controls and to the reference points from the driver's seat relating to the position of the motor home in traffic. Be cautious when maneuvering to allow for the length and width of the vehicle. Always allow extra room in cornering and when changing lanes. Check the side mirrors often. Learn to use the view of the roadway behind, as seen through the side mirrors, as a reference to help keep a good road /lane position.

Drive with consideration, observe all applicable speed and safety regulations. The best cruising speed for your motor home will vary with road and weather conditions. Remember that the higher speeds may result in a sharp increase in fuel consumption.

Driving on winding or mountain roads is not difficult if done with reasonable care. Observe proper vehicle speeds when ascending or descending hills and always operate in the proper transmission range.

Down shift on hills to avoid overheating or undue engine loads by using the hand control as recommended by the Chassis Operator's Manual.

Caution: If you are towing a vehicle or trailer with a Georgie Boy installed hitch, never exceed the maximum gross weight rating as listed on the tag on the hitch. For specific towing information and restrictions, see the trailering or towing guidelines published by the Chassis manufacturer. Also, consult your Chassis Owner's Manual.

Allow for the extra height of your motor home and avoid areas having low overhead clearance. Check for low-hanging tree branches or other obstructions whenever you drive or park. Avoid low roofs when pulling in for service. This may be particularly important if you drive with the overhead vents open or if the motor home is equipped with a roof air conditioner.

Note: It is not advisable to drive with the overhead vents open; and you must not drive with the TV antenna in the raised position.

When parking parallel, be sure to allow for poles or obstructions near the curb, as front and rear portions of the motor home swing wider than an automobile. When parking on an incline, it is recommended that the front wheels always be turned into the curb in the direction of roll to aid the parking brake.

Slide Out Room

If your motor home is equipped with the optional slide out room, it is imperative the operating instructions be followed every time the room is extended and retracted. Failure to follow the operating instructions can cause damage to components or cause readjustment of the room to be necessary. Operating instructions are posted in your unit.

Caution: Before traveling, make sure the factory supplied travel bars have been installed. This will prevent any accidental extension of the slide out room while vehicle is in transit.

The slide out room will operate the best when the chassis is on a level plane.

Leveling

When parking your motor home, choose a site that is as level as possible. If necessary, position pieces of wood in front of or behind the tire(s) that are lower than the others, and drive up onto the wood. Or you can level the motor home with the optional leveling jacks if your unit is so equipped.

Hydraulic leveling jacks are available on most models and leveling jacks are mandatory on most slide out units. Follow the operating instructions provided by the leveling jack manufacturer.

Caution: Failure to level the motor home can increase the difficulty of walking in your motor home and could lead to injury. Also, the coolant in the refrigerator/freezer may not flow properly and result in improper operation of that appliance. Also, the plumbing may not drain properly. Units with slide out rooms must be leveled with the leveling jacks before the slide out room is extended.

Engine Cooling System

The engine and cooling system on your vehicle should be operated and serviced as recommended in your Chassis Operator's Manual.

Per the chassis manufacturer's recommendations, check the coolant level, appearance and strength periodically. Also, check hoses regularly for signs of damage or deterioration. Tighten hose clamps as necessary. Replace hoses if they become hard and brittle and show signs of cracking or if they are abnormally soft, spongy or swollen. Also, replace hoses that are flaking or show deterioration of the inner lining. Flaking particles can clog the cooling system, reducing its efficiency.

WARNING: ANTIFREEZE IS FLAMMABLE, DEPENDING ON PRESSURE AND THE PERCENTAGE OF MIXTURE WITH WATER. FOR EXAMPLE, A SLIGHT LEAK IN THE COOLING SYSTEM CAN CAUSE POCKETS OF COOLANT TO COLLECT ON TOP OF THE ENGINE. ENGINE HEAT WILL CAUSE THE WATER IN THE MIXTURE TO EVAPORATE LEAVING A HIGH CONCENTRATION OF FLAMMABLE ANTIFREEZE. AS THE ENGINE GETS HOTTER, DUE TO A LOSS IN COOLANT, THE ANTIFREEZE CAN BURST INTO FLAMES AND CAUSE AN ENGINE FIRE. THIS IS ESPECIALLY TRUE WHEN THE ENGINE IS IDLING BECAUSE OF DECREASED AIR FLOW AROUND THE ENGINE.

If you suspect a leak, replace the coolant with a 50/50 mix of antifreeze and water. Then, fix the leak as quickly as possible.

Caution: The Automotive Air Conditioner places an additional load on the vehicle's cooling system. If the engine runs abnormally hot, shut off the air conditioner until the engine cools down.

Note: After a long drive, let the engine idle for a few minutes to gradually reduce the engine temperature.

Windshield Defrost - Comfort Control

During winter months in cold climates, it is important to keep the windshield clear and keep the passenger compartment at comfortable temperatures while on the road. This can be done by use of the proper combination of heater and defroster controls.

12-Volt Fuse Replacement

If part of your vehicle electrical system should fail while on the road, check the replacement circuit fuses located in the automotive circuit. These are automotive-type fuses available at most service stations. Refer to the Electrical section for information on living area 12-volt fuses.

Changing a Tire

For tire changing instructions, see the Chassis Operator's Manual. Your motor home is equipped with premium-grade truck-type tires. Under normal circumstances they should provide thousands of miles of trouble-free service.

Note: Routinely check tires for abnormal wear and if noted, have alignment checked.

Note: Changing a flat tire is best done by a skilled person with the necessary equipment. Your fully-loaded motor home is very heavy. Therefore, each wheel lug nut is torqued to a factory recommended setting, making the lug nuts extremely difficult to remove. In addition, each tire and wheel weighs approximately 90 pounds and is difficult to handle.

WARNING: LOOSENING THE REAR LUG BOLTS WILL RELEASE BOTH OUTSIDE AND INSIDE WHEELS. DO NOT ATTEMPT TO REMOVE LUGS WITHOUT HAVING A JACK IN PROPER POSITION TO ABSORB WEIGHT.

Note: If the flat tire is in one of the inside (rear) dual wheels, the outside wheel on that side will give adequate support and no immediate tire change may be required. Drive at reduced speeds...no more than 25 mph...to avoid overheating the single tire. Obtain assistance at the first service station.

Tire Chains

Caution: Your motor home is not intended to be operated with tire chains.

Emergency Start Switch

Your motor home is equipped with an emergency start mechanism. If you have left your headlights on and run down the battery, you can get the engine running by using the emergency start switch. The 12-volt battery that powers the 12-volt circuit in the living quarters is mounted behind the front bumper with your main automotive battery, with the exception of the diesel chassis battery which is located by the engine. The emergency start switch on the dash works like a built-in jumper cable that temporarily connects this auxiliary battery to the main automotive battery. Push the button to make the battery connection then turn the ignition key. Release the button when the engine starts. You may also have an optional second auxiliary battery.

Map Light Operation

Map lights are controlled by the dash instrument light dimmer switch. This switch must be in the dome position and the switch on the map light in the ON position for the light to operate. Some models have a separate dash switch for the passenger side light only.

Maintenance of Power Systems

Motor Home Chassis Operator's Manual

Refer to your Chassis Operator's Manual for information on chassis service recommendations. As a general practice, you should have the coolant, battery and the engine oil levels checked at regular intervals.

Radiator Service

Keep the proper amount of antifreeze/coolant in your radiator. When driving or storing the motor home in freezing temperatures, test the ability of the antifreeze to protect the engine and radiator from freezing. If necessary, drain weak antifreeze and replace with fresh antifreeze to protect well below anticipated temperatures. Refer to the recommendations in the Operators Manual supplied by the chassis manufacturer.

Engine Service

Items serviced from the exterior of the motor home are reached through either the front engine access door or the rear engine access door on diesels. These doors permit servicing the 12-volt batteries, the radiator and coolant system, the engine oil level and oil filler cap, the power steering reservoir and windshield washer.

The engine compartment cover, located between the driver and passenger seats on gas units, gives access to the air cleaner and allows access for major service. Diesel engine access can also be obtained from under the rear bed. When the engine is being serviced from inside the motor home, protect your carpet and furnishings against oil and dirt. Your serviceman will be glad to use a protective cloth if you remind him.

Note: Proper engine servicing and record of servicing may be mandatory to ensure chassis warranty protection. Follow the manufacturer's instructions for periodic maintenance checks.

Generator Power Plant System Service

Generator power plant service, recommended by the generator manufacturer, should be performed at an authorized service center (listed in the material

provided in your Owner's Information Kit.) Routine or emergency service, such as adding oil, changing filters or replacing spark plugs, could be accomplished at auto service centers, but must be done in accordance with the service instructions specified by the manufacturer.

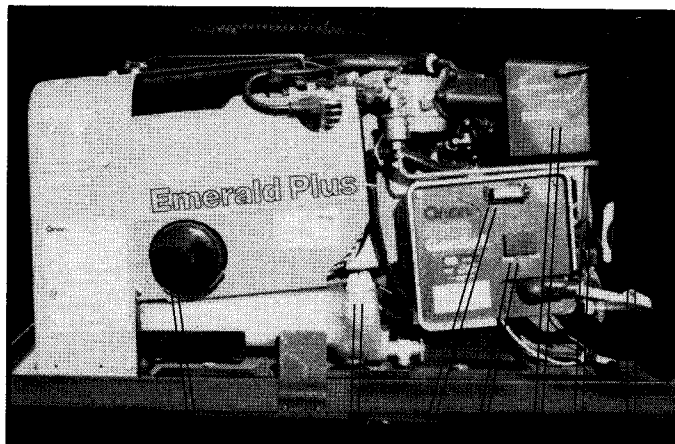

Typical Generator

1. Oil Filter
2. Oil Fill
3. 10 Amp Fuse
4. Start/Stop Switch
5. Air Pre-Heater Switch
6. Circuit Breakers
7. Hour Meter

An hour meter is installed inside the motor home or at the generator. This meter indicates the hours of running time on the generator. Keep track of this information in order to schedule proper generator maintenance.

Circuit breaker(s) on the generator protect the wiring between the generator and the main circuit breaker box. If you have reason to repair the generator, turn the breaker(s) on the generator to the OFF position while making the repair. If you don't, a power surge could damage electrical components inside the motor home.

Engine Removal

Engine removal can be accomplished in one of two ways. The first is to drop it through the bottom of the chassis frame. The second is to lift it through the engine cover and out the passenger side window. There is never a need to remove the front fiberglass cap to gain access for engine removal.

Recovery Towing on the Road

If your motor home needs to be towed the following guidelines should be used:

1. The vehicle *MUST* be towed only from the front. See *Chassis Operator's Manual*.
2. Be prepared to give the tow truck operator at least the following information when you call:

Length and height of motor home.
Chassis Manufacturer gross vehicle
Weight rating.
Axle weight ratings.

(This information is found on the vehicle certification label located to the left of the drivers seat.)

3. It is recommended that you ask for an **UNDERLIFT** (wheel lift or frame lift) type towing assembly for safe towing.

To prepare your motor home for towing:

1. Secure any loose or protruding body parts of the disabled vehicle.
2. Secure any heavy loose items in the interior.
3. Turn off all LP gas appliances and LP gas tank valve.
4. Do not allow any person to ride in the towed vehicle.

EMERGENCY TOWING

Caution: Do not allow your motor home to be towed without having the tow truck operator read this section and related sections of the *Chassis Operator's Manual*.

Georgie Boy Manufacturing does not assume responsibility for damage incurred while towing this vehicle.

Electrical Systems

Your motor home has two electrical systems. One provides 120-volt (AC) power to operate all 120-volt living area receptacles and appliances. This system is used when power is available from an external power source or from an on-board generator power plant, if one is installed. The standard power rating for this 120-volt service is 30 amps. However, 50-amp service is an available option.

The second system uses an on-board battery or a 12-volt (DC) converter to provide power for all 12-volt lighting, appliances and accessories, as well as normal vehicle needs.

Generator Receptacle

If your motor home is equipped with a generator, obtain power from the generator by plugging the power cord into the generator receptacle in the electrical compartment. When connected in this manner, the generator provides 120 volts to your electrical circuits.

Battery Service

Periodically check your main automotive battery and your auxiliary battery(s) for proper charge, proper cable connections and physical damage. Before starting on a trip, or after extended storage of the motor home, remove the battery cables, clean the terminal posts and cable connections if needed and apply a light coating of grease to prevent corrosion.

120-Volt System Power Supply Cord

Either a 30-amp or a 50-amp power-supply cord is provided in the electrical compartment. When stationary, pull it out and connect it to any adequate power source to activate the power circuits. For optimum performance, use this power cord only with the proper mating connector and only with facilities having the same amperage as your motor home. Such facilities are available in most parks and grounds.

Caution: Using your power cord with power supplies that have less than the rated capacity or using the plug with receptacles for which it was not designed, may damage your appliance and make the warranty inapplicable.

Caution: Make sure the main circuit breaker on the 120-volt circuit breaker panel is in the OFF position while plugging or unplugging the power cord. This protects your major electrical appliances from power surges during plugging and unplugging operations.

Generator

If you have chosen an electrical generator, it is located in a special compartment below the motor home floor on the driver's side or in a compartment at the rear of the unit.

The compartment is sound insulated and constructed to prevent vapors from seeping into the living area.

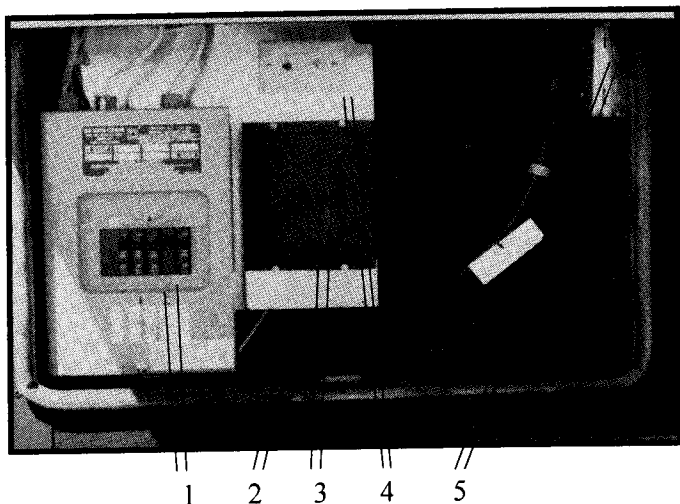

Typical Electrical Compartment

1. 120-Volt Circuit Breaker Panel
2. 12-Volt Converter
3. 12-Volt Converter Fuse Panel
4. Cable TV and Telephone Jacks
5. Generator Receptacle

However, be aware it is possible, with certain wind conditions, fumes from the generator exhaust pipe could enter the motor home through open windows.

Starting the Generator

The generator can be started by a switch on the generator itself or through a remote start system. There is a remote switch on the dash instrument panel. The remote switch has an indicator light so that you can tell when the generator is running.

To start the generator, hold the switch in the START position until the unit starts, DO NOT hold the switch in the START position for more than 10 seconds. Release the switch, wait 15 seconds, then repeat. This will help avoid overheating the generator starting motor and may prevent damage to the starting system.

If this system fails to start, the generator manual starting instructions are indicated in the Generator Power Plant Manufacturer's Instructions. To stop the unit, hold switch to STOP position until the engine stops operating. Be sure switch does not stick and returns to neutral position.

WARNING: ALL WINDOWS AND DOORS SHOULD BE CLOSED ANYTIME THE GENERATOR IS RUNNING.

Note: Refer to the Generator Power Plant Manufacturer's Instruction Manual for service information before starting the generator.

Note: Do not start unit with a heavy power load. Always wait at least three minutes after starting generator before turning on (or plugging in) heavy electrical loads. (Example: When optional roof air conditioner is installed.)

Generator Fuel

On a gasoline-powered motor home, the generator operates on gasoline taken from the automotive fuel tank. The generator is fed by a special tube which is higher in the tank than the feeder tube to the motor home engine. This is to prevent immobilizing the motor home by accidentally permitting the generator to run the fuel tank dry.

Refrigerator/Freezer

The refrigerator/freezer is powered by both electricity and LP gas. Consult the refrigerator manual for operating instructions.

When stationary, make sure the motor home is level in order to obtain optimum cooling performance from the refrigerator/freezer.

Electrical Appliances

Roof Air Conditioner

Your motor home may be equipped with either one or two optional air conditioners. These are installed on the roof and require 120-volt power from the generator or from an external power source.

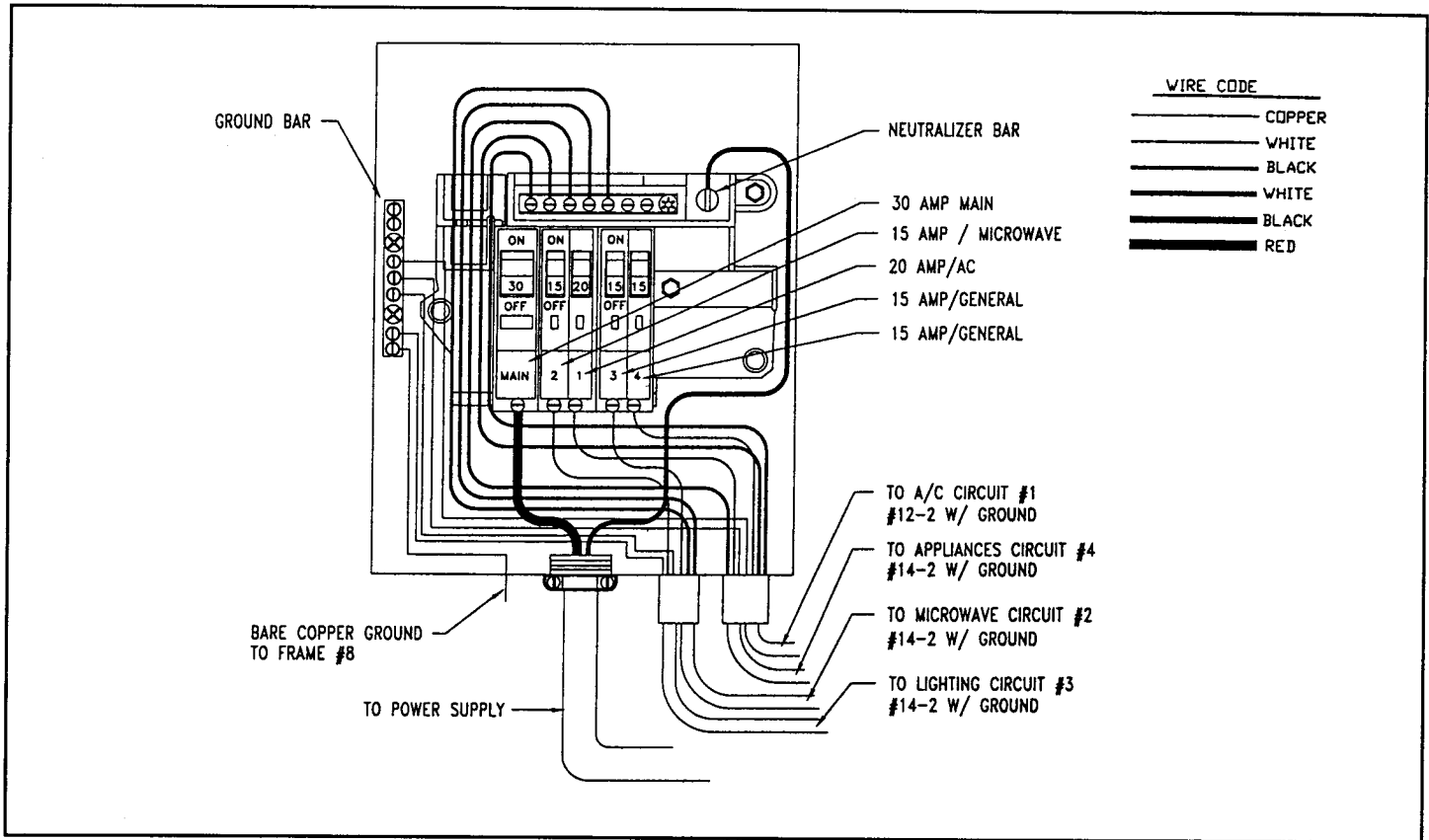

Typical 120-Volt 30-Amp Electrical Circuit

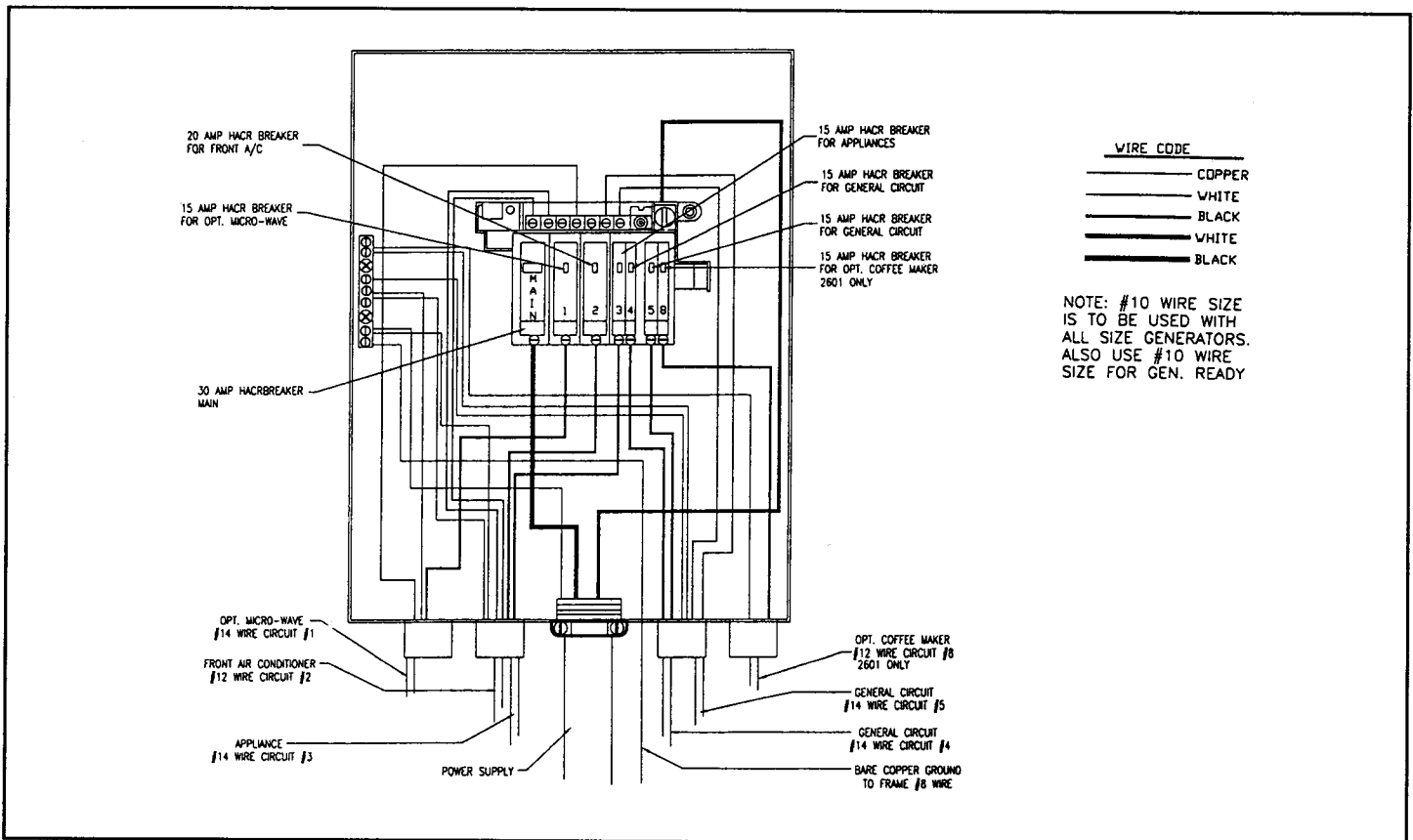

Typical 120-Volt 30-Amp Electrical Circuit (CSA)

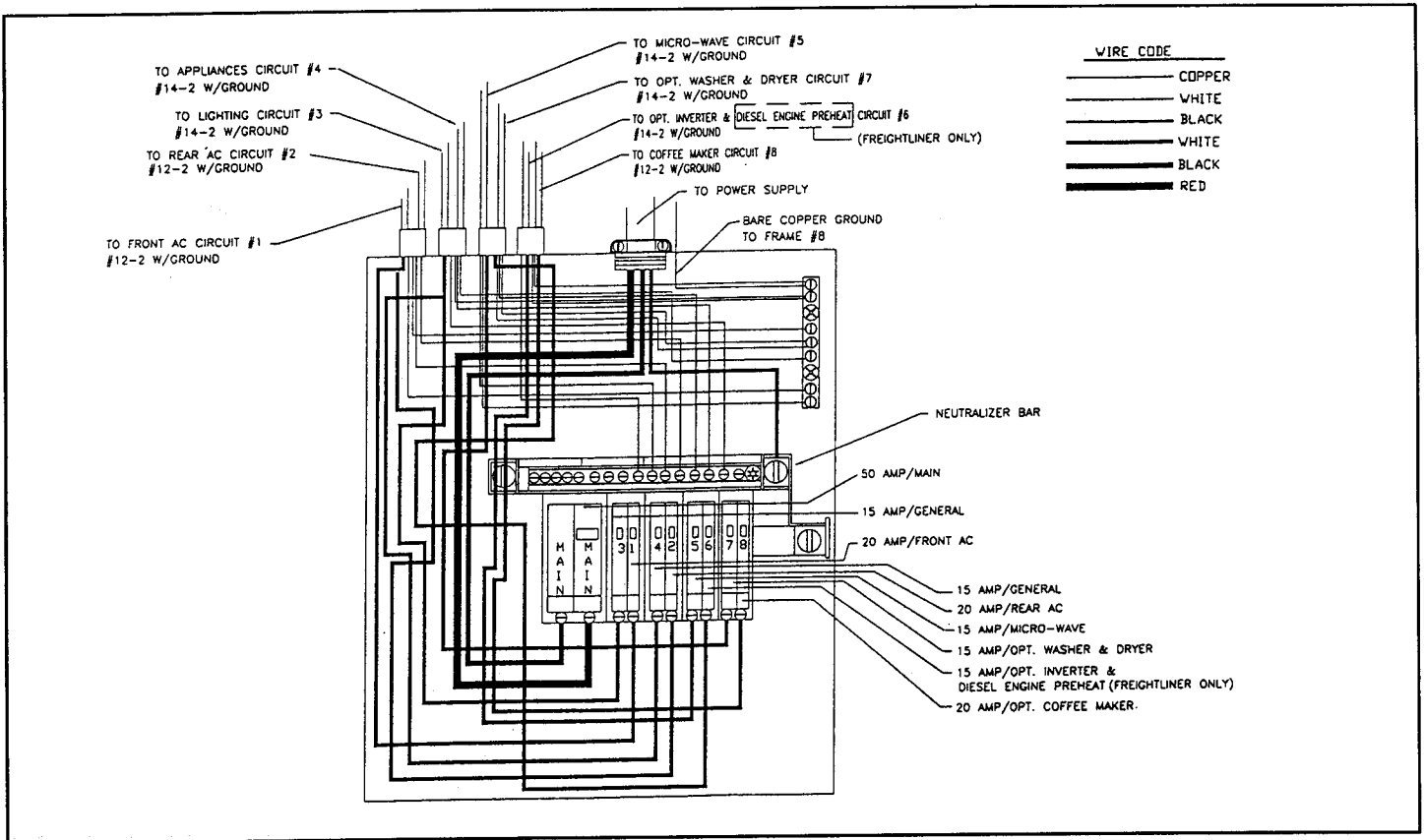

Typical 120-Volt 50-Amp Electrical Circuit

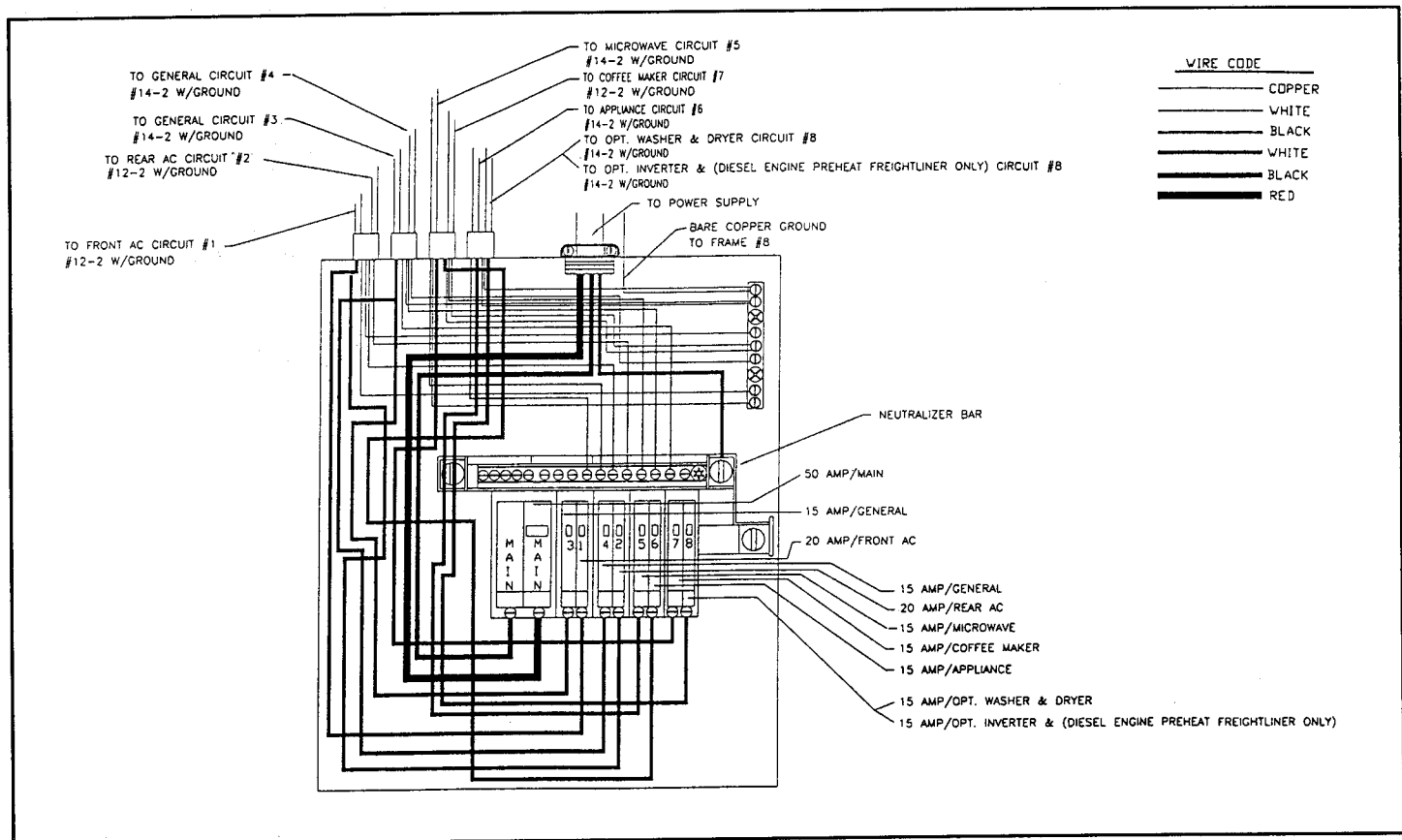

Typical 120-Volt 50-Amp Electrical Circuit (CSA)

1. RIGHT FRONT LIGHTS 20-AMP #12 WIRE - BLUE
2. RIGHT MIDDLE LIGHTS 20-AMP #12 WIRE - YELLOW
3. LEFT FRONT LIGHTS 20-AMP #12 WIRE - BROWN
4. LEFT MIDDLE LIGHTS 20-AMP #12 WIRE - ORANGE
5. REAR LIGHTS 20-AMP #12 WIRE - BLACK
6. FURNACE 20-AMP #10 WIRE - RED
7. FURNACE 20-AMP #10 WIRE - RED/WHITE
8. MONITOR 15-AMP #12 WIRE - ORANGE/BLACK
9. SEWER LIGHT 20-AMP #12 WIRE - PURPLE

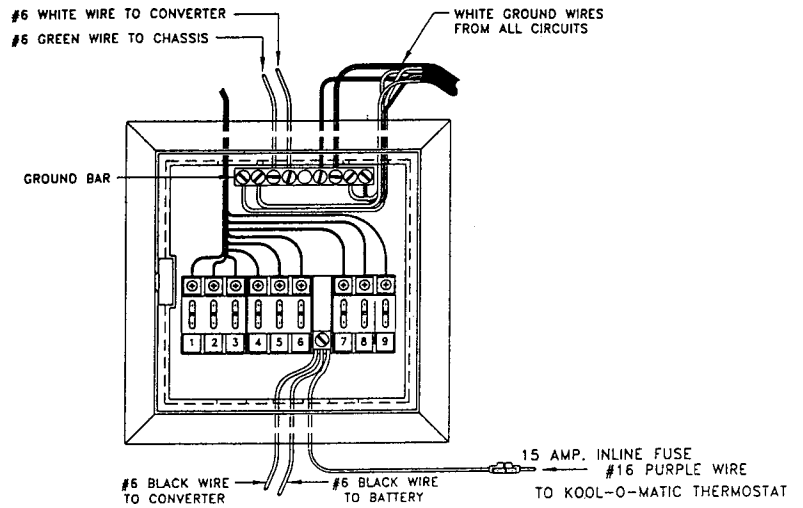

Typical 12-Volt 9-Circuit Power Converter Fuse Panel

1. RIGHT FRONT LIGHTS 20-AMP #12 WIRE - BLUE
2. RIGHT MIDDLE LIGHTS 20-AMP #12 WIRE - YELLOW
3. LEFT FRONT LIGHTS 20-AMP #12 WIRE - BROWN
4. LEFT MIDDLE LIGHTS 20-AMP #12 WIRE - ORANGE
5. REAR LIGHTS 20-AMP #12 WIRE - BLACK
6. FURNACE 20-AMP #10 WIRE - RED
7. FURNACE 20-AMP #10 WIRE - RED/WHITE
8. MONITOR 15-AMP #12 WIRE - ORANGE/BLACK
9. POWER VENT & SEWER LIGHT #12 WIRE 20-AMP - PURPLE
10. LEFT/RIGHT HALOGEN SINGLE BULB LIGHTS 20-AMP #12 WIRE - RED/YELLOW
11. LEFT/RIGHT INDIRECT LIGHTING 20-AMP #12 WIRE - YELLOW/BLACK
12. OPT. REAR RADIO 15-AMP #12 WIRE - ORANGE/RED

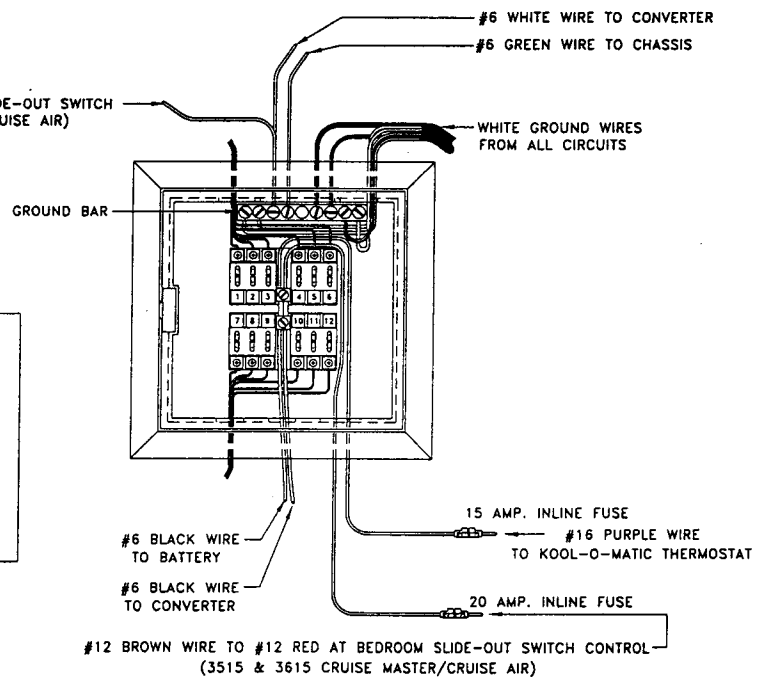

Typical 12-Volt 12-Circuit Power Converter Fuse Panel (CSA)

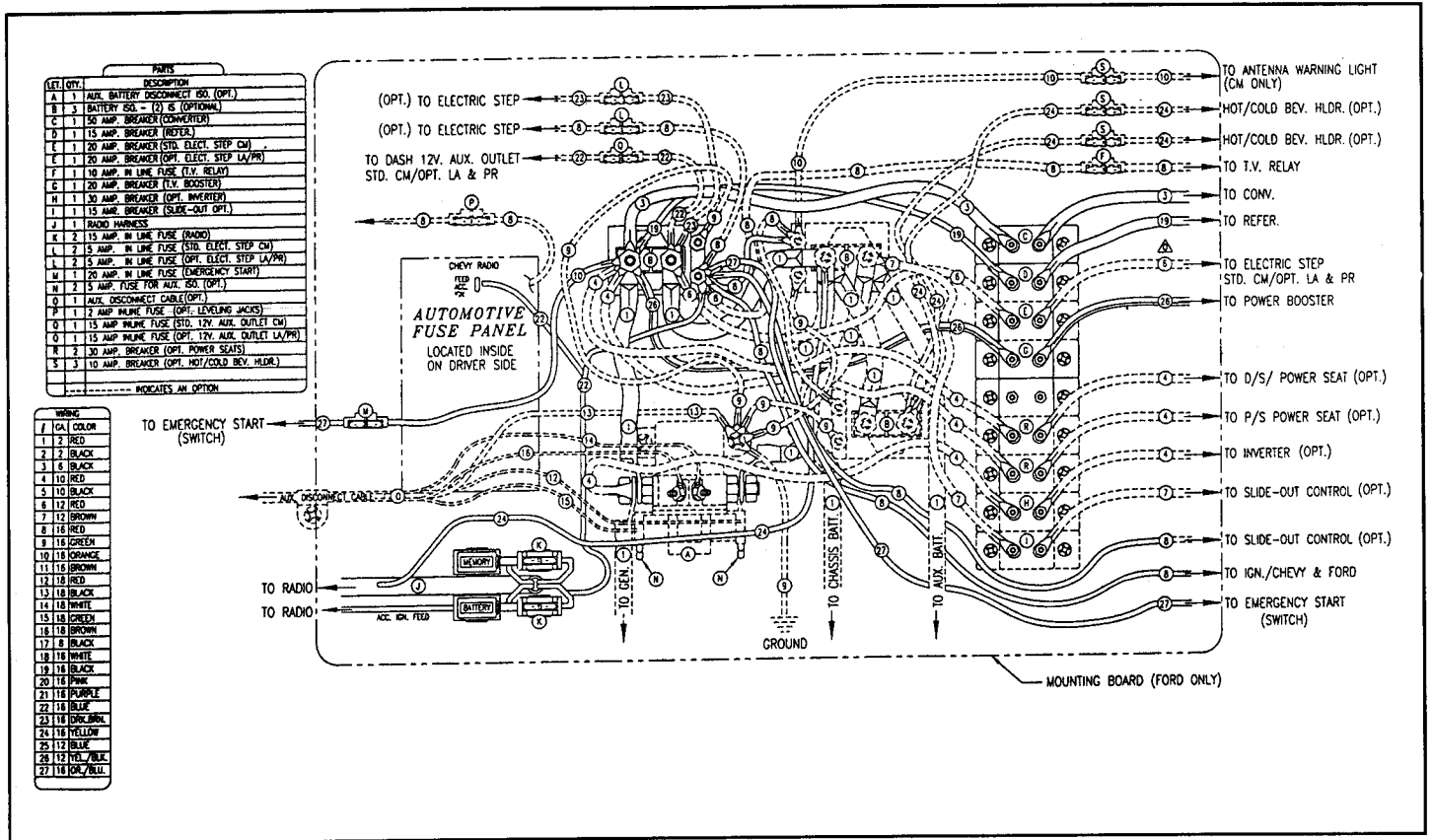

Typical Automotive Electric Circuit (Chevrolet and Ford)

With 30-amp service, only one roof air conditioner is available and is operated off either the generator or an external power source. With 50-amp service, two air conditioners may be operated off either the generator or the external power source.

Caution: If the air conditioner is switched off for any reason, wait a few minutes before starting it again to avoid overloading circuit breakers.

When the air conditioner is not being used, always keep controls in deactivated position (Warm Off) to reduce unnecessary circulation of refrigerant.

For best results, carefully follow all instructions provided by the air conditioner manufacturer with regard to operation and maintenance.

Keep air filter screen clean and working properly, especially in dusty or dry areas.

Ducted Roof Air Conditioner (Optional)

Your motor home may be equipped with an in-ceiling air conditioner duct system controlled by a remote wall mounted thermostat.

The ceiling registers are designed to be turned clockwise to open and counter clockwise to close. These vents are designed not to close completely. This

is to assure the unit won't freeze up the evaporator coil and shut down the condenser, if in the event all registers are shut and the air conditioner is running.

Maintenance

Air filter: Periodically remove the return air filter. Wash the filter with soap and warm water, let dry and then reinstall or replace as required.

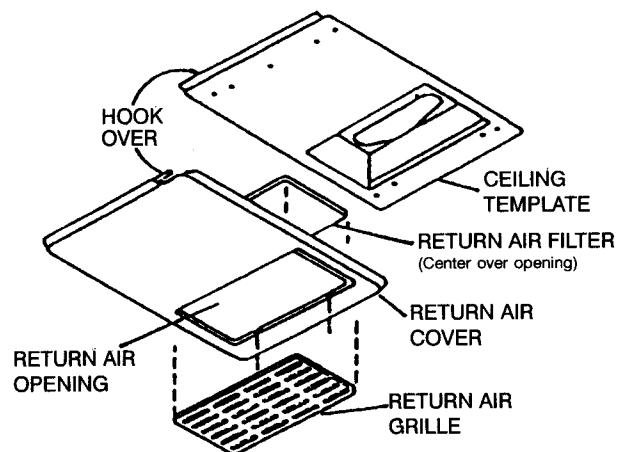

Note: Never run the air conditioner without the return air filter in place. This may plug the unit evaporator coil with dirt and may substantially affect the performance of the unit.

12-Volt Batteries

When the power supply cord is not connected to a 120-volt external power source or the generator, power for lights and 12-volt appliances is automatically provided from the auxiliary battery.

When 120-volt power is available, a voltage converter allows you to run your 12-volt lights off the 120-volt power source, thus saving a drain on your 12-volt automotive battery.

Extended use of the 12-volt auxiliary batteries will drain it of power. However, if not drained too far, it will be recharged automatically when power is supplied by a 120-volt source. It will also be recharged by the automotive alternator while the engine is running.

WARNING: DO NOT STORE ANYTHING NEAR EITHER THE MAIN ENGINE BATTERY OR THE AUXILIARY BATTERY. ALSO, DO NOT PLACE ANY TOOLS ON THE BATTERIES. THESE ITEMS COULD CAUSE AN ELECTRICAL SHORT CIRCUIT, DRAIN POWER FROM THE BATTERY, CAUSE AN EXPLOSION WHICH WOULD SPRAY BATTERY ACID AND/OR START A FIRE.

Caution: Do not store items near the voltage converter in the electrical compartment. The converter could overheat and fail to function properly or become damaged.

12-Volt Fuses

The fuses for the 12-volt electrical system are located for easy access. Fuses for the chassis circuits are located on a panel under the dash beside the steering column as well as on the exterior side of the firewall.

Note: If a fuse, circuit breaker or fusible link replacement is necessary, replace with one of the same amperage. Most circuit breakers can be reset.

Liquid Petroleum Gas System

WARNING: LP GAS CONTAINERS SHALL NOT BE PLACED OR STORED INSIDE THE VEHICLE. LP GAS CONTAINERS ARE EQUIPPED WITH SAFETY DEVICES WHICH RELIEVE EXCESSIVE PRESSURE BY DISCHARGING GAS INTO THE ATMOSPHERE.

Liquid Petroleum (LP) gas is the energy source for your range, oven, furnace, water heater and also the generator on diesel units. It is also an alternate power source for your LP gas/electric refrigerator.

LP gas is a colorless gas, but is stored under pressure as a liquid. It is commercially available under the brand name, Propane. Though odorless in a natural state, LP gas is artificially odorized to smell like garlic for easy detection in the event of a leak. The gas and the tank in which it is stored are safe and convenient, provided sensible precautions are followed.

Caution: Be aware that travel vibrations may cause the LP gas tank and fittings to loosen, resulting in leaks. Ask your authorized dealer to inspect the tank and fittings at least once a year and after every extended trip. You can also check for leaks by applying Mr. Bubble to all fittings and the welds on the mounting brackets. If you discover a leak, extinguish all nearby flames, tighten the fitting(s), and test with more Mr. Bubble. If the leak persists, close the shut-off valve and seek immediate repair from an authorized dealer.

LP Gas Tank

The LP gas tank is in a compartment on the passenger side of the unit..

Caution: LP gas is flammable and potentially explosive. Use proper handling, lighting and ventilating procedures. As a gas, Liquid Petroleum is heavier than air and will dissipate if ventilation is provided to permit a downward flow.

WARNING: LP GAS REGULATORS MUST ALWAYS BE INSTALLED WITH THE DIAPHRAGM VENT FACING DOWNWARD. REGULATORS HAVE BEEN EQUIPPED WITH A PROTECTIVE COVER. MAKE SURE THAT THE REGULATOR VENT FACES DOWNWARD AND THAT THE COVER IS KEPT IN PLACE TO MINIMIZE VENT BLOCKAGE, WHICH COULD RESULT IN EXCESSIVE GAS PRESSURE CAUSING FIRE OR EXPLOSION.

The frame mounted tank has four controls; gas pressure regulator, vapor withdrawal (service) valve, fill valve and gauge. To provide LP gas to appliances, first open the vapor withdrawal service valve all the way (counterclockwise) then close it 2/3 of a turn. When all LP gas systems are not in use, close the valve all the way.

Caution: Do not use pliers or a wrench to tighten valves. If a valve is not leak-tight when closed by hand, see your LP gas service representative. Extinguish all pilots and open flames, stop engine and stop the auxiliary power generator, if installed, before filling LP gas tanks or fueling your vehicle tanks. Pilots and open flames should be extinguished when the vehicle is under way and, by regulation, must be extinguished in certain areas such as tunnels or restricted areas. Check ahead to areas where you plan to travel to determine any special regulations which may apply.

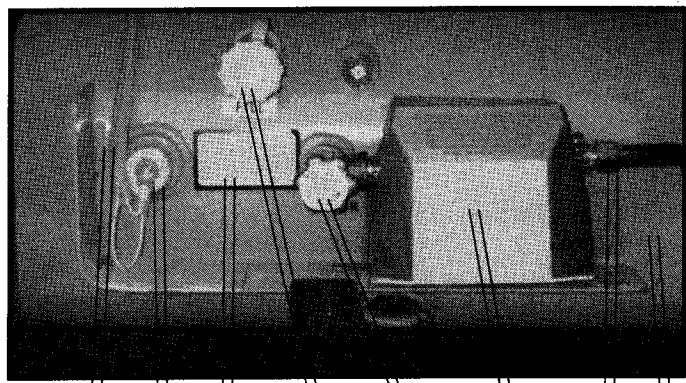

Typical Liquid Petroleum Gas Tank

1. Electrical Lead to Component Monitoring System
2. Fuel Level Indicator and LP Gauge Sender
3. Warning Label
4. Fill Valve
5. Shut Off Valve
6. LP Regulator
7. Gas Line to Appliances
8. LP Gas Tank

Filling the LP Gas Tank

A WARNING LABEL HAS BEEN LOCATED NEAR THE LP GAS CONTAINER. THIS LABEL READS IN PART: "DO NOT FILL CONTAINER(S) TO MORE THAN 80 PERCENT OF CAPACITY." OVERFILLING THE LP GAS CONTAINER CAN RESULT IN UNCONTROLLED GAS FLOW WHICH CAN CAUSE FIRE OR EXPLOSION. A PROPERLY FILLED CONTAINER WILL CONTAIN APPROXIMATELY 80 PERCENT OF ITS VOLUME AS LIQUID LP GAS.

Drive the vehicle to an LP gas supplier or one of the service stations which sells LP gas to have the tank filled. Look under Gas, Liquefied Petroleum, Bottled and Bulk in your classified directory or refer to the service directory available at your dealer. For additional information, refer to instructions for your gas appliances provided in your Owner's Information Kit.

LP Gas System Leak Checks

For your safety, check for leaks in your gas system each time that tank is filled or before each trip. Always check the system any time the odor of garlic is detected. To perform a leak check, open the valve and spread a ample quantity of Mr. Bubble soap solution over all connections. Escaping gas will create visible bubbles to show the location of any leak.

WARNING: NEVER CHECK FOR LEAKS WITH AN OPEN FLAME. IF THE LEAK CANNOT BE LOCATED, TAKE THE UNIT TO AN LP GAS SERVICE REPRESENTATIVE.

Keep the tank valve closed and turn OFF all appliances if the unit is not being used.

Using your LP Gas System at Low Temperatures

Your gas system will function well at low temperatures provided the components are kept at a temperature above the boiling point of the gas.

The following are suggestions to keep gas appliances working smoothly:

1. Choose a type of LP gas which has a boiling point lower than any temperature you expect to encounter. Ask your LP gas supplier or your motor home dealer for information on products available in your area.
2. If outside temperatures get below the boiling point of the LP gas in your system, keep exposed area (such as the tank, regulator and lines) at a higher temperature with a protective cover.
3. Keep the system free from water vapor which may turn to ice in lines and regulators. Commercial additives such as dry methylalcohol, added to the LP gas tank, can help avoid water condensation in the regulator and the lines. Ask your LP gas supplier or your Georgie Boy dealer.

If, despite precautions, the gas flow to your appliance should fail at low temperatures, the stoppage may be due to ice in the LP gas regulator as a result of condensed moisture. Try melting the ice by warming the regulator, using a small light bulb on an extension cord. **DO NOT USE AN OPEN FLAME.** Once flow is restored, it may be necessary to protect the regulator or continue to provide a little heat in order to keep the moisture from freezing again. If the

problem persists, ask your LP gas supplier to service the tank or regulator by removing the moisture or adding an ice-inhibitor as required.

LP Gas Leak Detector

All units will have an electronic LP gas leak detector. You should consult the operating instructions as provided with your Owners Packet for information.

LP Gas Appliances

Your range top and oven, furnace and water heater operate on LP gas, while your refrigerator can operate on either LP gas or electricity. Warranty certificate registration cards, service instructions and other information are included in the Owner's Information Kit provided with the motor home. All information relating to your appliances should be kept readily available for easy reference.

Note: Be sure to fill out and mail the warranty registration cards on all appliances as soon as possible.

It is important to carefully follow all operating and lighting instructions provided on or near each appliance (or in your Owner's Information Kit.) For the initial lighting of an LP gas appliance, it may be necessary to purge the LP gas supply line of air before the appliance will light. To purge a line, open a burner or a pilot valve and hold a flame near the burner. Allow time for air to escape. The time will vary depending on the distance the appliance is located from the LP gas tank. After several seconds, the gas should ignite and burn steadily.

WARNING: ALL PILOT LIGHTS, APPLIANCES AND THEIR IGNITORS (SEE OPERATING INSTRUCTIONS) SHALL BE TURNED OFF DURING REFUELING OF MOTOR FUEL TANKS AND/OR LP-GAS CONTAINERS.

WARNING: THE FOLLOWING LABEL HAS BEEN PLACED IN THE VEHICLE NEAR THE RANGE AREA: IF YOU SMELL GAS:

1. **Extinguish all open flames, pilot lights and all smoking materials.**
2. **Do not touch electrical switches.**
3. **Shut off the gas supply at the tank valve(s) or gas supply connection.**
4. **Open doors and other ventilating openings.**

5. **Leave the area until the odor clears.**

6. **Have the gas system professionally checked and leakage source corrected before using again.**

Range Top and Oven

WARNING: IT IS NOT SAFE TO USE COOKING APPLIANCES FOR COMFORT HEATING.

Unlike homes, the amount of oxygen supply is limited due to the size of the recreational vehicle, and proper ventilation when using the cooking appliance(s) will avoid dangers of asphyxiation.

The range top and oven in your motor home are provided with a vent or range hood. Always use the fan when using the oven or range top in order to ensure adequate ventilation. When cooking for long periods of time with a large number of people in the home, it may be desirable to open a window or a roof vent slightly to further increase ventilation level.

When igniting the oven, note that the type of heat-actuated ignition control used for the main oven burner may result in a normal delay of a few seconds, after the oven control knob is turned ON, before the main oven burner ignites. Anticipate approximately five seconds delay for the burner to ignite. If it doesn't ignite within five seconds, turn the control knob OFF and check the gas supply. Refer to the appliance manual further for instructions.

Caution: Do not use open flames, such as the oven or range top, to warm the living area because gas combustion consumes the oxygen inside the home.

Forced Air Furnace

Your motor home is equipped with a forced-air ducted circulation system. The temperature can be regulated at the wall-mounted thermostat. The furnace will keep room temperatures at a comfortable level by activating fan and gas controls as temperatures inside the motor home vary. Refer to information on lighting, operation, adjustment and service on the furnace case and in the appliance manual.

When storing the motor home, turn the thermostat and the fan to the OFF position. Failure to shut off the fan may result in excessive drain on, and damage to, the auxiliary battery.

Water Heater

Your motor home is equipped with an LP gas fueled water heater. The heater is a storage type much like in your home. There is a thermostatic control on the heater to maintain the water temperature within a preset range.

The water heater has an electronic ignition. To ignite the heater, press the water heater switch on the component monitoring system in the kitchen.

Before igniting the water heater, make sure that it is filled with water by turning on a hot water faucet, such as the one at the galley sink. If water is supplied from the on-board fresh water tank, the pump must be ON. If water flows continuously, the heater is full of water. If water does not flow (and pressurized water is available,) leave the faucet open until the tank fills.

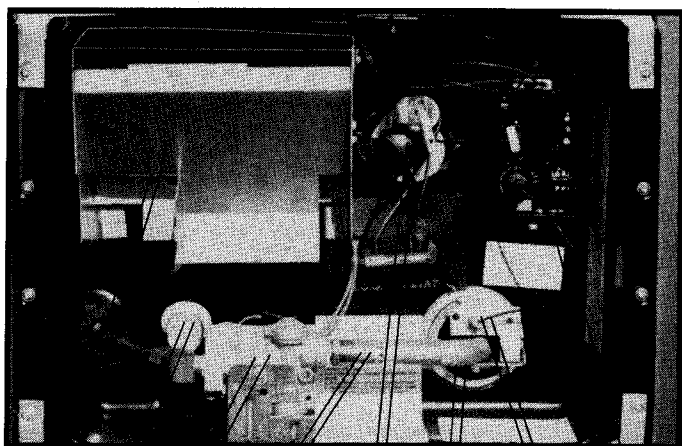

Water Heater

- | | |
|-----------------|-------------------------------|
| 1. Burner Vent | 5. Pop-Off Valve |
| 2. Drain Valve | 6. Burner Assembly |
| 3. LP Gas Valve | 7. Igniter |
| 4. Venturi Tube | 8. Electronic Ignition Module |

For complete operating instructions, refer to the manufacturer's instruction manual or see the instructions under the heater access panel.

Models with optional pre-heat only operate the preheat portion while the vehicle engine is running.

LP Gas/Electric Refrigerator

Your refrigerator will operate on electricity or LP gas. Consult the operating instructions furnished by the

manufacturer in the manual. Before operating the refrigerator, be sure the motor home is level. If it is not level, circulation of the refrigerant may be blocked by liquid accumulated in the condenser coils and cooling action could stop. Check the level of the refrigerator by placing a bubble-type leveling device (available from your dealer) on the freezer shelf. Level the motor home with jacks and/or blocking under the wheels. (See leveling instructions.)

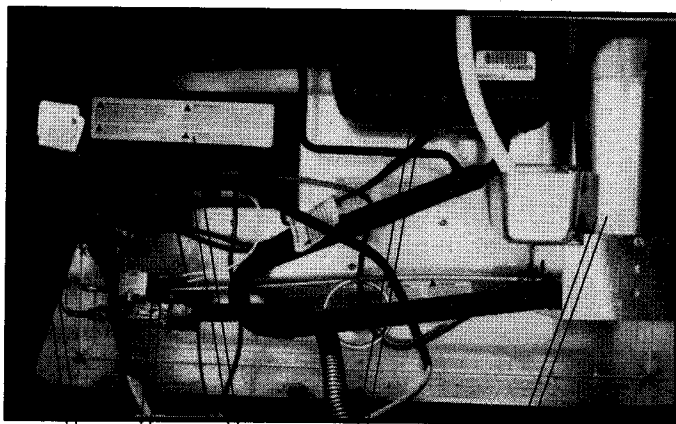

Refrigerator Vent

1. 120-Volt Electrical Power Supply
2. LP Gas Power Supply
3. 12-Volt Power Supply
4. Coolant Reservoir
5. Burner Tube

Note: Unlike most household refrigerators, the refrigerator will be completely silent when operating on electric power.

Your range top and oven, furnace, water heater and some generators operate on LP gas, while your refrigerator can operate on either LP gas or electricity.

Warranty certificate registration cards, service instructions and other information are included in the Owner's Information Kit provided with the motor home. All information relating to your appliances should be kept readily available for easy reference.

Note: Be sure to fill out and mail the warranty registration cards on all appliances as soon as possible.

Plumbing Systems

Fresh Water

Fresh water is provided from one of two sources:

1. City water, provided under pressure when the motor home is hooked up to a park or city water supply.
2. Water stored in an on-board water tank with pressure provided by a pump operating automatically from your 12-volt electrical system.

External Water Supply

When camped in a park or near a city water supply, connect the water supply to the motor home as follows:

1. Turn water pump switch inside the motor home to OFF.
2. Remove protective cap over city water inlet pipe on your motor home.
3. Connect an approved hose to the motor home inlet and to the city water supply line.
4. Turn city water supply valve to ON.
5. Let the water run a few minutes with your supply line attached to clean the lines.

Caution: Both the on-board pump and on-board fresh water tank are now isolated from the water pressure in the system. Do not turn pump on until pressure line is disconnected to avoid damaging the pump.

Use the following procedure to disconnect the city water supply:

1. Turn the city water supply valve to the CLOSED position.
2. Disconnect the water hose from the motor home inlet connection and replace inlet pipe protection cap. Store the water hose in the space available in the holding tank compartment.

Filling Fresh Water Supply

The on-board fresh water supply in your motor home provides fresh water automatically to all systems whenever a faucet is opened. Pressure is provided by a 12-volt DC automatic self-priming pump which

functions any time power is available and the pump switch is ON.

Filling the fresh water tank is very easy and convenient. While the water hose is connected to the water inlet, turn the water tank fill valve 1/4 turn until the on-board fresh water tank is filled. Then turn the valve back to its normal position. You can determine when the water tank is full by either monitoring the indicator lights on the component monitoring system or by observing water drain onto the ground from the overflow tube.

Caution: Do not run the pump without water in the system. Always keep the switch off when the water system is empty of water or when connected to city water. Running the pump when dry can damage it and may make the warranty inapplicable.

WARNING: USE ONLY POTABLE (DRINKING QUALITY) WATER IN THE TANK. TO ENSURE CLEAR, FRESH WATER, DRAIN TANK AFTER USING. FLUSH AND DRAIN BEFORE EACH USE AND SANITIZE IF SYSTEM SEEMS TO GIVE WATER AN ODD TASTE. SEE DIRECTIONS FOR SANITIZING THIS SYSTEM.

Troubleshooting the Water System

During normal use, your pump should operate automatically (if power is provided and the pump switch is ON) whenever a faucet is turned on. Should your on-board water supply fail to function when a faucet is opened, check to see that the pump switch is ON and make sure that your Fresh Water tank contains water. If the switch is ON, check the fuse. If no pressure is available, although the pump switch is ON, power is available and the pump fuse is intact, refer to the information provided by your water pump manufacturer for instructions.

If the water pump continues to operate when no water is being used, there may be a leak in the system or in a faucet. If no leak is found and the pump continues to operate, refer to the information provided by the water pump manufacturer for additional checks.

Caution: When storing the motor home in freezing temperatures, be sure that all water system components, including the storage tank, are drained or protected by a special type of non-freezing additive if the vehicle is to be left unheated.

Winterizing the Water System

Your motor home has a self-contained "double holding tank" drainage system. Waste water from the toilet flows into the "black water tank" and depending on

your floor plan, waste from the shower, vanity and sinks enter either the "gray water" or "black water" tank. Both tanks may be used while in transit.

1. Turn the water drain valve located directly below the water inlet. Hold the drain valve open until water ceases to flow from the water holding tank.
2. Open hot and cold faucets inside the motor home.
3. Open the water heater drain plug located inside the water heater access door.
4. Open the two drain valves on the water pump.
5. Locate the air valve attachment stored in the holding compartment and attach it to the water inlet.
6. Using a pressurized air hose, force air pressure into the water lines.
7. Continue applying air pressure until only air comes out of the faucets, the drain on the water heater and the drains on the water pump. Then stop applying the air.
8. Drain the toilet and flush any remaining water into the waste water holding tank.
9. Pour ½ cup of RV antifreeze in each drain in the kitchen sink, bathroom vanity and shower. After completing the above procedure, drain the waste water holding tanks per instructions.

Judicious Use of Fresh Water

People who are not accustomed to motor home living are frequently surprised at how much water can be used and wasted. Although your fresh water tank is large, your water supply will not last long unless you alter water consumption habits that are common in conventional houses. For example, shut off the water while you brush your teeth, use only what you need to wash and rinse dishes, and turn off the shower while lathering, then turn it back on briefly for rinsing.

Sanitizing Water Tank

It is suggested that your fresh water tank be renewed periodically using a chlorine solution followed by clear water rinses.

1. Connect a garden hose to the fresh water inlet hookup.
2. Pour one cup (8 oz.) of liquid household chlorine bleach into the garden hose and connect the other end to a household water faucet.

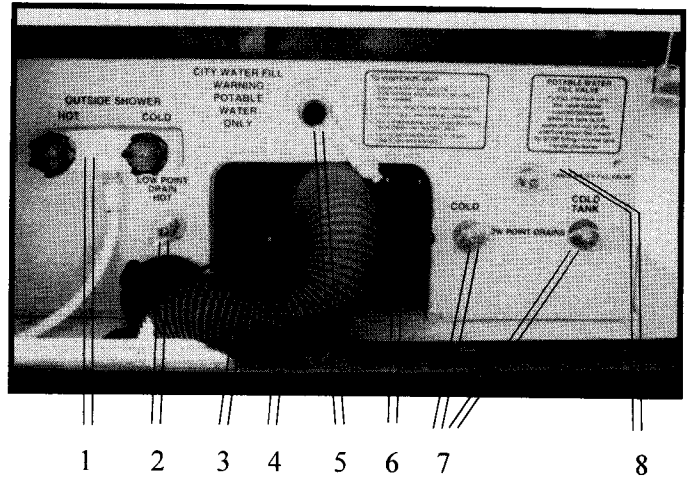

Typical Holding Tank Compartment

1. Hot & Cold Controls for Outside Shower
 2. Low Point Drain for Hot Water
 3. "Gray Water" Knife Valve
 4. Sewer Hose
 5. Fresh Water Fill
 6. "Black Water" Knife Valve
 7. Low Point Drains
 8. Fresh Water Fill Valve
3. Fill balance of tank with potable water.
 4. With pump ON, open each faucet long enough for water to run out, to remove all air from system and lines.
 5. Allow the system (now filled with chlorine solution) to stand for at least three hours. Before performing the following step, provisions should be made to allow for drainage of all water from the fresh water tank.
 6. Flush the piping by running water through faucets for at least one minute each.
 7. Turn pump OFF.
 8. Drain tank and pipes by opening tank drain valve. Open each faucet to permit water to drain from each pipe.
 9. When the tank is empty and each faucet has been opened, drained and closed, close the drain valve.
 10. Fill system with clear fresh water.
 11. Repeat steps 6 through 9.
 12. Partly fill the system with fresh water and check the tank and system for taste and odor. If a chlorine taste or other traces of impurity remain,

go to step 13. If the system is clear go to step 14.

13. Prepare a solution of 1-quart vinegar in five gallons of water and place in tank. Fill the system completely. Agitate this solution by vehicle motion, then repeat steps 4 and 5.
14. Repeat steps 6 through 9 to empty the system.
15. If the system is to be used, fill with fresh water. If not, the system is ready for storage.

Waste Water System

Your motor home has a self-contained "double holding tank" drainage system. Waste water from the toilet flows into the "black water" tank; and depending on your floor plan, waste from the shower, vanity, and sink enters either the "gray water" or "black water" tank. Both tanks may be used while in transit.

The valves for the holding tanks are accessible in the plumbing compartment. The holding tanks are located on either side of the plumbing compartment.

These tanks can be removed, if necessary, by removing screws on the lower sides of the access panels then raising the panels on the hinges at the top.

Empty the tanks only at a proper sanitary disposal station. Drain the tanks when they are nearly full or at the end of your trip. It is not advisable to drain the tanks when they are less than 3/4 full, especially the "black water" tank because a certain amount of liquid is necessary to properly remove solid wastes.

The process of draining the waste water holding tanks is best done while wearing rubber gloves. To drain the holding tanks:

1. Make sure the knife valves on both the "black water" tube and the "gray water" tube are pushed in to the CLOSED position.
2. Remove the plastic sewer hose from the capped storage tube. The hose has been compressed for storage but will extend as needed.
3. Remove the cap from the drain tube and securely attach the sewer hose. Make sure that the clips catch firmly to hold the sewer hose in place.
4. Insert the ground end of the sewer line into a ground sewer or dump station outlet, pressing it firmly far enough into the opening to be secure. In

some cases, adapters may be required between the line and the inlet. Arrange sewer line between motor home outlet and dump station so that it is free from dips.

5. Drain the "black water" tank first by opening the knife valve. To open, grasp the handle firmly and pull with a quick steady motion.
6. Allow sufficient time for the tank to be completely drained. Rinse and flush tank if necessary. Then, push knife valve inward to close valve.

Note: Dirty tanks may cause a false reading on the Component Monitoring System.

7. Repeat this process with the "gray water" tank.

Note: By draining the "black water" first, you are using the "gray water" to rinse any solid waste particles that may have been left in the sewer hose.

8. Remove the sewer hose and replace the cap on the waste water line.
9. Use a hose to rinse out sewer hose
10. Remove the sewer hose from the sanitary disposal site.
11. Compress the sewer line back into its storage tube, and replace sewer or dump station cover if applicable.

Please...use good housekeeping when draining wastes at a campsite or disposal station. Leave the site in good order. Above all, avoid pollution of lakes and streams.

Do's and Don'ts – Waste Tanks

- DO keep your holding tank clean using any cleaner approved for recreational vehicle sanitation systems.
- DO add a special deodorizer or chemical additive approved for recreational vehicle systems to sanitize and improve the tank action.
- DO guard against freeze-up.
- DO keep your tank knife valve closed, permitting the tank to get as full as convenient before emptying.

- DO keep tank knife valve and the drain cap tightly in place when traveling to permit use of the system when on the road.
- DO use any soft (single-ply) toilet tissue.
- DO open the bath vent to keep bathroom fresh.
- DON'T put facial tissues, paper, alcohol type anti-freeze, sanitary napkins or household toilet cleaners in your holding tank.
- DON'T put anything solid in your holding tank which can scratch or damage the plastic.

Component Monitoring System

Many on-board systems can be monitored from one location. For your convenience, this monitoring system is mounted near the kitchen area.

From this one location, you can check:

- The status of all three holding tanks: "black waste water," "gray waste water," and fresh water
- The charge in your 12-volt auxiliary batteries

There is also a switch to turn on the:

- Water pump

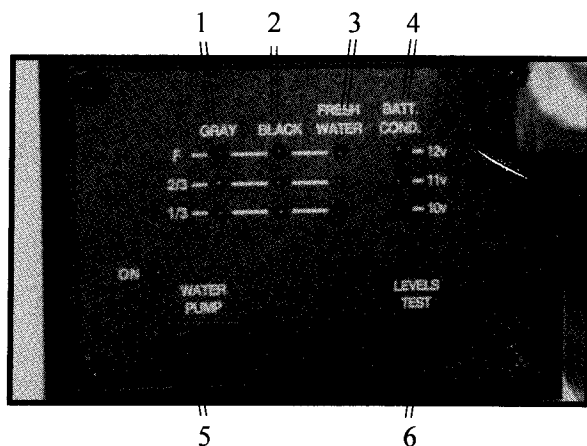

Component Monitoring Panel

- | | |
|---------------------------|-----------------------|
| 1. Gray Water Tank Level | 4. Battery Condition |
| 2. Black Water Tank Level | 5. Water Pump Switch |
| 3. Fresh Water Level | 6. Levels Test Switch |

Note: On some models, a switch for the water pump is also located in the bathroom and a switch for the generator is also located on the dash instrument panel.

Equipment and Furnishings

Cockpit Pedestal Seats

The seat can be moved forward or back by using the levers provided. Arm rests can be set in either the up or down position. Be certain that the seat controls are firmly latched and secure prior to driving the vehicle and never adjust the seat position while in motion.

Dinette Bed

A combination dinette and bed may be provided on some models. This dinette combination may be converted into a bed as follows:

1. Fold the table leg by releasing the catch. Relocate the table by lifting the end (to release from the support brackets.) Let the table, with the leg folded, drop into down position.
2. Arrange cushions to make a bed.

Storage

Storage facilities on your motor home have been especially designed to remain secure while the vehicle is in motion. Most exterior compartments have key-operated locks. Drawers rest in small notches or detents when closed; to open, lift slightly to clear the detent, then pull open normally. For best results, follow a few simple rules when storing articles in the motor home.

1. Always keep tools and equipment stored in areas where they will not shift while traveling.
2. Wherever possible, place heavy articles in storage compartments which are low and between the axles for better weight distribution.
3. Use a "packaging" technique of the articles in a compartment to prevent shifting. If necessary, secure articles with straps to prevent movement.

4. Be sure that containers holding liquids are capped and cannot tip or split. When glass containers (or dishes) are transported, secure them well to protect against accidental breakage.

WARNING: ON SOME MODELS, STORAGE COMPARTMENTS UNDER THE SOFA BED, UNDER THE MASTER BED AND IN SOME CLOSETS ALSO CONTAIN FURNACE UNITS. DO NOT STORE ANYTHING IN THE AREA OF THE FURNACE THAT WILL BLOCK OR RESTRICT RETURN AIR FLOW ALSO, DO NOT STORE ANY COMBUSTIBLES IN THIS FURNACE AREA.

WARNING: THE STORAGE COMPARTMENT UNDER THE MASTER BED IS EQUIPPED WITH A HEAVY-DUTY SPRING MECHANISM THAT ALLOWS YOU TO EASILY LIFT THE BED BOARD AND MATTRESS. HOWEVER, IF YOU SHOULD EVER REMOVE THE MATTRESS, BE CAREFUL WHEN LIFTING THE BED BOARD. STAND OUT OF THE WAY. WITHOUT THE WEIGHT OF THE MATTRESS, IT WILL COME UP FASTER THAN YOU MIGHT EXPECT.

Care and Maintenance

Interior Cleaning

Wall Paneling

The paneling of your motor home may be any of several finishes and textures. Never use strong detergents or abrasive cleaners on walls or ceilings. Most surfaces will clean with a soft cloth which has been dampened with mild liquid detergent in warm water, avoid the use of large amounts of water. Many panel suppliers suggest that one of the aerosol products designed for cleaning and preserving wood surfaces may be excellent for walls if used in accordance with manufacturer's instructions.

Draperies, Cushions, Bedspreads and Upholstery Fabrics

Due to the various fabric yarns, print inks and dyes, fire resistant finished where required, and various other treatments applied to the fabrics used to make the above items, we recommend professional dry cleaning only. Professional cleaning will preserve the finishes and appearance of these products.

Vinyl fabrics may be cleaned using a mild detergent and a damp sponge or cloth.

Fixtures

Sinks, baths, showers or other plastic fixtures should be cleaned only with warm water and mild detergent or special cleaners. The plastics manufacturer recommends Ajax Spray Cleaner with ammonia, Joy dishwashing liquid and water or a mixture of 25% bleach and 75% water.

Do not use harsh abrasives. They may scratch or discolor the surface, causing it to have to be replaced.

Windows

Moving parts of windows and latches should be kept adjusted and maintained. It is advisable to lubricate the windows with a light oil or powdered graphite at least once a year. The screws holding the windows in place should be checked and tightened periodically and the weather sealant checked for voids. Screens may be cleaned by gently wiping with a damp cloth or soft flat brush designed for the purpose.

Locksets and Latches

Annual lubrication of locksets and latches is recommended to ensure trouble-free operation. If your motor home is located at the beach or is exposed to salt air, more frequent lubrication may be needed. One of the lubricants recommended by many locksmiths is powdered graphite, available in a handy tube at most hardware or supply store.

A record should be kept of the identification number of keys, with the make of lockset in your home. With this information alone it will be possible to obtain duplicates for any key that might be lost.

Carpeting

Use any approved cleaning product or procedure which is recommended for cleaning indoor-type carpets.

Plumbing

The water supply plumbing should require little, if any, maintenance. Refer to information provided by the water pump manufacturer for any special maintenance recommendations on the pump mechanism. Refer to the recommendations from the toilet or tank manufacturer relating to maintenance or to chemical additives which may be appropriate for those

components. Plumbing system drains and traps should be kept clean. Chemical products recommended for plastic pipe may be used in the drain lines. Precautions must be taken when using a mechanical device to remove obstructions from a drain line, to avoid damage to fittings and seals. Build-up of waste on level sensors or walls of the holding tanks could result in false readings on the Component Monitoring System. Special cleaning may be required.

Condensation and Ventilation

It is important that moisture-laden air not be allowed to build up inside your motor home. Moisture build-up is often evident from the forming of a water film on windows and other cooled surfaces. Particular precautions may be appropriate in kitchen or bath areas where normal washing or cooking activities can release water vapor or steam into the air. The following steps are recommended:

1. Keep air circulating by providing ample fresh air through adequate ventilation.
2. When using shower, keep the bath vent open. Keep bathroom door closed for 20 or 30 minutes after use to permit moisture to escape through the vent.
3. Avoid hanging wet clothing to dry inside the motor home. If it cannot be avoided, use the ventilated bath with the door closed.

WARNING: MANY PRODUCTS IN THIS VEHICLE CONTAIN FORMALDEHYDE. IT IS A SUBSTANCE WHICH MAY BE AN IRRITANT TO SOME PEOPLE, UNDER SOME CIRCUMSTANCES. YOU MAY EXPERIENCE A GREATER CONCENTRATION DURING HIGH HUMIDITY AND TEMPERATURES, BUT YOU WILL NOTICE THAT THE FORMALDEHYDE EMISSIONS QUICKLY DECREASE. IF YOU ARE AFFECTED, VENTILATE THE MOTOR HOME AND LEAVE IT UNTIL THE FORMALDEHYDE DISSIPATES. PLEASE CONTACT OUR CUSTOMER SERVICE DEPARTMENT IF YOU DESIRE ASSISTANCE.

Exterior Care

Exterior Glass and Trim

The exterior finish on your motor home is as easy to care for as the finish on your car. To keep it clean, simply hose it down with water, wiping the wet surface

with a cloth or sponge if necessary. Do not use harsh abrasives or strong solvents on exterior surfaces. Accumulated dirt or road film resulting from storage or from heavy travel should loosen easily with warm water and a mild detergent. Rinse with plain water. Application of a good quality automotive wax will protect the finish still more and add luster to the color.

Caution: Be careful when washing your motor home that you do not aim water directly into the furnace vent, water heater vent or dryer vent. Rusting and improper operation could occur if water is forced past the protection rain baffles.

Maintenance of Fiberglass Components

The front and rear caps and other fiberglass components of your Georgie Boy motor home are constructed of fiberglass for its light weight, design flexibility, corrosion resistance and strength.

Exposure to sunlight, water, dust and chemicals can be detrimental to the gel coat surface, causing chalking, discoloration, yellowing or loss of gloss. Simple periodic maintenance procedures will minimize these changes.

It is the responsibility of the owner to make sure proper maintenance is performed.

1. Wash frequently with mild detergent. Do not use automatic dishwasher detergent, abrasives, bleaches, strong chemicals with acids/bases or ammonia.
2. Wax at least twice a year or more in high sunlight areas. Use a wax recommended for fiberglass finishes and follow the manufacturer's application procedures.
3. Never wax in direct sunlight.
4. Do not store in direct sunlight. Stubborn spots, minor scratches or nicks may be removed with a fine grit rubbing compound followed by waxing. Deep marks or gouges should be professionally repaired.

Roof

The adhesives and sealants used to construct your roof have been chosen especially to remain waterproof

under the sustained effects of weather and vibration. Wash dirt and grime from the roof when washing the motor home to help minimize deterioration of the roof materials.

Periodically, inspect the roof with careful attention to possible scrapes or cuts caused by overhanging obstructions. Repair any damaged spots with appropriate repair materials from your dealer. Do not use trailer roof coatings.

The rubber roof can become dirty with everyday exposure to the elements however, it can be kept clean with periodic cleanings.

We recommend washing the roof at least four (4) times per year using a mild household detergent. If the roof is in an area where it collects dirt and other pollutants, we recommend using Spic-N-Span and medium bristle brush to clean the membrane.

If the membrane has exhibited some mild "chalking", following the Spic-N-Span, we suggest using concentrated cleaners such as ZEP Formula 50, Protect All Wash or general purpose windshield washer fluid (no petroleum or citric based cleaners) as a secondary cleaning to remove any surface "dust" that may remain.

Please note that in some climates or areas with unpleasant atmospheric conditions, the roof may require this type of cleaning more often.

While using Amor-All or a similar product may seal the roof for awhile, as this protectant weathers away problems may reoccur if cleaning is not continued.

Concerning stubborn stains (like fruit or tree sap) small amounts of Mineral Spirits on a rag, or undiluted laundry bleach, will reduce but not likely eliminate the stain.

Often overlooked, is the weathering of the roof seal. The roof seal will certainly weather quicker than the roof, especially in hot climates. As the seal weathers, it may experience surface degradation and chalking. Many times the lap seal can be the cause of some white residue on the vehicle, rather than the roof itself.

While the lap seal can be cleaned with those products listed earlier, the best method to clean the seal and remove any weathered surface is to use Mineral Spirits on a rag and wipe all seal surfaces. If the problem repeats in 2-4 weeks, it may be necessary for a light covering of new sealant to be applied over the old seal. The old seal must be cleaned with Mineral Spirits first to clean and reactivate the surface, enabling the new sealant to adhere to the old. Please note that skylights (not vents) require resealing with Sikaflex #221.

Sealant Check of all Seams and Moldings

Checking of all seams and moldings for deterioration, shrinkage and cracking of the protective sealers should be performed at least once every six months. Resealing should be done as soon as any of these conditions are noticed to prevent damage from water leakage. When resealing, use only quality sealers compatible with the ones originally used on your motor home. Make sure all surfaces to be resealed are clean and all old sealant has been removed. Contact your dealer or Georgie Boy if you have any questions.

Repairs

Your dealer should be able to perform most repairs or service required for your motor home. Repair or service for warranted appliances in your motor home will normally be handled through the appliance manufacturer in accordance with warranty instructions provided in the owner's kit. Your dealer will be glad to assist if you have difficulty obtaining service through your appliance service representative.

Refer to your Chassis Operator's Manual and to other information provided by the chassis manufacturer for chassis service instructions.

Repair of glass, fiberglass, aluminum or some plastic components can often be accomplished by camper/trailer service firms or by automobile body shops. Check with your dealer or look in the classified section of your telephone directory or newspaper.

It is recommended that all chassis body bolts be checked once a year for tightness to prevent rattles due to vibration.

Extended Storage

If your motor home will not be used for a period of several weeks, you should perform certain procedures to maintain its performance capability over that period of time.

Water System

Refer to the water blow-out procedure.

Kitchen Appliances

Refer to the manuals provided by the manufacturers of these appliances.

Furnace Fan and Thermostat

Make sure that the switches for both the furnace fan and thermostat are in the OFF position.

Electric Step

Shut off the switch by the passenger entrance door.

Plumbing Compartment Light

Turn off the light in the plumbing compartment.

Auxiliary Battery Disconnect Panel

An auxiliary battery disconnect panel is an optional feature on your motor home. It is located either on the dash or in the stepwell near the passenger entrance door.

By pressing the switch on this panel, you are able to disconnect the auxiliary batteries from the 12-volt electrical circuits. This operates in the same manner as if you physically disconnected the cables from the batteries, but it is much more convenient.

If you disconnect the electrical circuits with the battery disconnect panel, it is not necessary to shut off individual electric components.

Note: This battery disconnect feature is intended to be used only when the motor home is to be stored for an extended period of time.

Emergencies

Smoke Detector

Your motor home has a smoke detector mounted on the ceiling near the kitchen. Test it at least once a year, or before beginning each trip. To test the smoke detector, press the button in the middle of detector. It should

emit a loud piercing sound...the same sound you will hear in case of emergency. If it does not make that sound, replace the batteries.

Fire Extinguisher

The fire extinguisher is mounted in a bracket just inside the passenger entrance door. This is a convenient location for use both inside and outside the motor home. Before using your motor home, familiarize yourself with the proper operation of the fire extinguisher. Basic instructions are found on the fire extinguisher label. More detailed information is in a booklet as part of your Owner's Information Packet.

Note: Read this information and learn how to operate the fire extinguisher now. In an emergency, it is too late to read the instructions.

CO Detector

WARNING: CARBON MONOXIDE CANNOT BE SEEN OR SMELLED AND CAN KILL YOU. IF ALARM SOUNDS: TURN OFF APPLIANCES, VEHICLES OR OTHER SOURCES OF COMBUSTION AT ONCE (FURNACE, WATER HEATER, RV, AUTOMOBILE, ETC.) AND CALL THE FIRE DEPARTMENT. GET FRESH AIR INTO PREMISES OR VEHICLE. HAVE THE PROBLEM CORRECTED BEFORE RESTARTING APPLIANCES OR VEHICLE.

Operating Your Detector

See the instruction sheet which came with your detector for complete information. Operating your CO Detector is easy. Once power is supplied, the detector will run through a warm-up and self-check cycle for ten minutes before beginning to monitor for CO gas. There are no switches to allow the unit to be accidentally turned off, so the LECO will provide reliable protection (providing that the test procedure performed) by alerting you to the buildup of potentially dangerous levels of CO gas on a continuous basis.

Escape Routes

Every passenger location in a motor home can be evacuated through at least two emergency exits. In case one route is blocked, you have an alternative route.

On the Pursuit, the emergency exits are the driver entrance door, the passenger entrance door and a window in the bedroom.

Note: Some windows slide and others push out at the bottom. Know how your windows open.

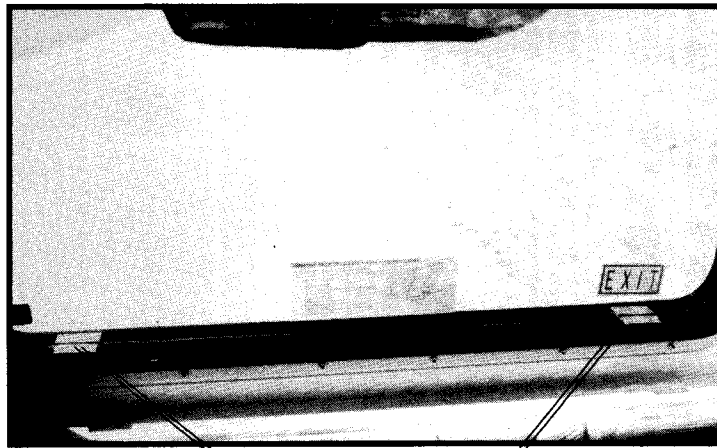

Red Latches

The emergency window(s) are marked with an EXIT sticker and bright red latches. To use this escape exit:

1. Unlock the latches.
2. Open the window.
3. Crawl through the window.
4. Call for help.

Note: Locate the emergency exit windows in your motor home.

Ground Fault Interrupters

Certain 120-volt circuits are wired with ground fault interrupters (GFI) to prevent electrical shock. The receptacles protected by a GFI are the outdoor patio receptacle, all receptacles in the bathroom and the kitchen area and some receptacles on the passenger side of the motor home. If you should experience an interruption of electrical power in any of these receptacles, push the reset button on the receptacle in the bathroom. If the interruption in power occurs again immediately, there is a short somewhere in the circuit and you will need to find and fix it before using the circuit again.

Service

Optimum Service Satisfaction

You can contribute greatly to your level of satisfaction with dealer repairs by following a few simple service guidelines:

1. Make a list of the items that need to be repaired. Often these are minor, incidental things that you may discover in the normal, day-to-day operation of your motor home. Make your list as you notice these items. Include any emergency work that may have been done by an unauthorized motor home mechanic since your previous service appointment.
2. Allow sufficient service time. Each item on your list will take a certain amount of time to repair satisfactorily. Discuss the list of repair items over the phone when you call for an appointment. Your dealer's service department can give you a time estimate. Schedule the appointment well in advance of the date that you want to leave on a trip. Allow for extra time, especially if parts must be ordered. Reconfirm the repair time estimate in person with the service manager.
3. Prioritize your repair list. If you are in a hurry, discuss this with the service manager and decide which repair items should be fixed first. If the entire list cannot be completed, schedule another appointment at a more convenient time.
4. Discuss warranty repair items. When you schedule the appointment, tell the service manager if any warranty work must be done. Show him the warranty registration papers.
5. You should stay in the dealer's customer lounge. This is for your safety, for insurance reasons and to facilitate the mechanic's work on your motor home.
6. Inspect the mechanic's work. Even if you cannot watch the mechanic, you should exercise your right to carefully inspect the repairs once they are completed. Give it a visual inspection and go for a test drive if necessary. If you are not satisfied, talk with the service manager not the mechanic. Allow the service manager to test drive the motor home if necessary. If time does not allow for immediate repair, make another appointment as soon as possible.

If You Are Not Satisfied

If, for some unusual reason, a problem is not handled to your satisfaction, we make the following suggestions:

1. Discuss any warranty related problems directly with the General Manager or the Owner of the dealership, give him an opportunity to help his service department resolve the matter for you.
2. Should a problem arise that cannot be resolved to your satisfaction by your local dealer, contact Georgie Boy Mfg., Inc. Service Department Monday - Friday, 8:00 am - 5:00 pm Eastern time at (616-663-3415 or 1-800-521-8733).
3. The above steps are suggested because of our sincere belief that your dealer will satisfactorily handle any problem which might arise. Should you find it necessary to correspond with our factory, please send a letter describing the circumstances to:

Georgie Boy Mfg., Inc.
69950 M-62
Edwardsburg, Michigan 49112

Please include model and serial number of your vehicle.

Your dealer and we, the manufacturer, will continually strive to merit your confidence.

Thank you for choosing our product.

Reporting Safety Defects

If you believe that your vehicle has a defect which could cause a crash or could cause injury or death, you should immediately inform the National Highway Traffic Safety Administration (NHTSA) in addition to notifying Georgie Boy Mfg., Inc.

If NHTSA receives similar complaints, it may open an investigation and if it finds that a safety defect exists in a group of vehicles, it may order a recall and remedy campaign. However, NHTSA cannot become involved in individual problems between you, your dealer, or Georgie Boy Mfg., Inc.

To contact NHTSA, you may either call the Auto Safety Hotline toll-free at 1-800-424-9393 (or 366-0123 in Washington, D.C. area) or write to: NHTSA, U.S. Department of Transportation, Washington, D.C. 20590. You can also obtain other information about motor vehicle safety from the Hotline.

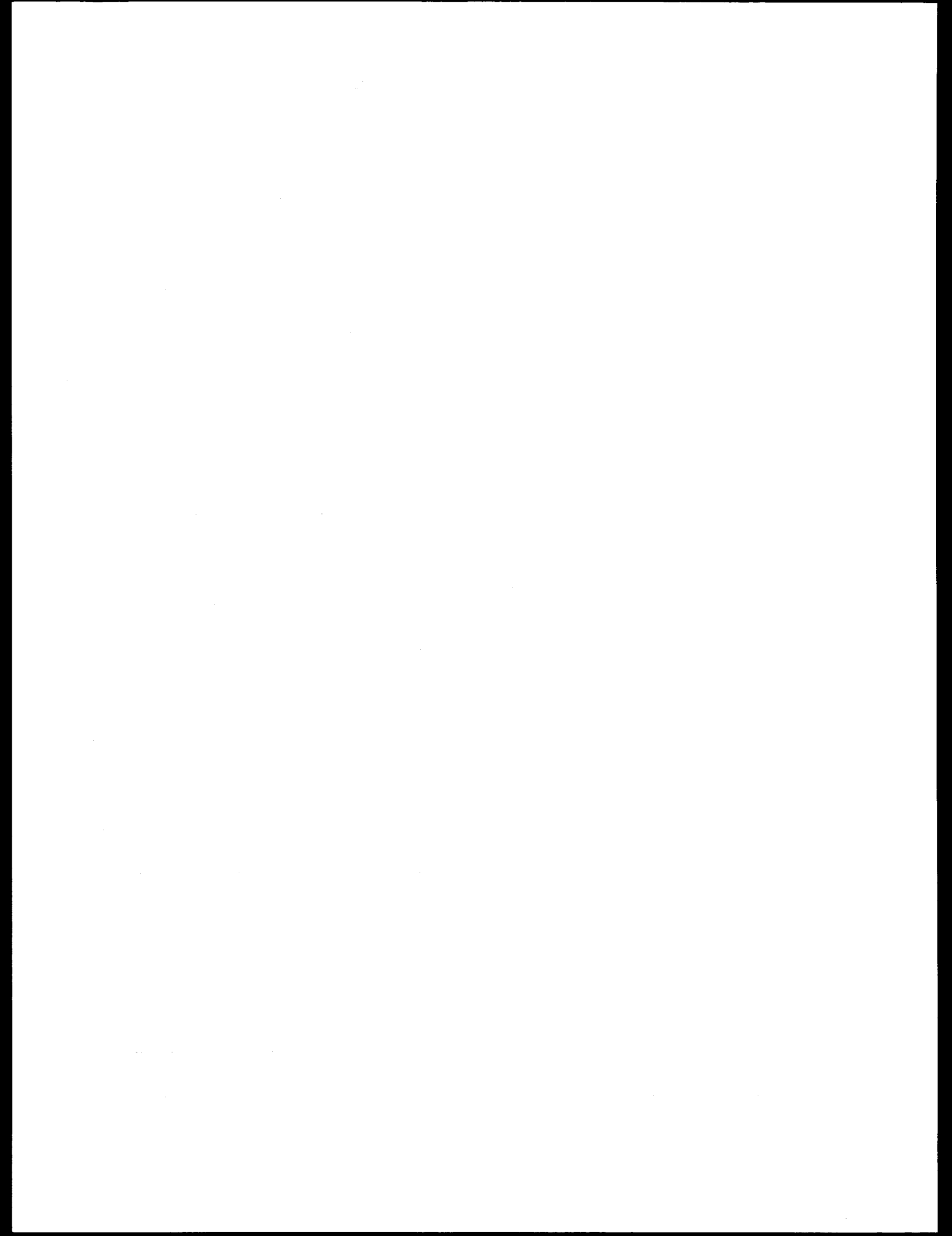

Index

| | | | |
|--|----|--|-------|
| Air Conditioners - Roof | 16 | Generator Receptacle | 11 |
| Batteries -12-volt | 17 | Generator Starting | 12 |
| Battery Service | 11 | Ground Fault Interrupters | 29 |
| Changing a Tire | 9 | Interior Cleaning | 25 |
| Chassis Operator's Manual | 9 | Leveling | 8 |
| Child Restraint Precautions | 6 | Load Capacity | 2 |
| CO Detector | 28 | LP Gas System | 17 |
| Condensation and Ventilation | 26 | LP Gas Tank | 17 |
| Construction Standards | 2 | LP Gas Leak Detector | 19 |
| Dinette Bed | 24 | LP Gas Appliances | 19 |
| Driver's Compartment | 7 | LP Gas Tank - Filling | 18 |
| Driving and Parking | 8 | LP Gas System Leak Checks | 18 |
| Ducted Roof Air Conditioner | 16 | LP Gas System - Low Temperatures | 18 |
| Electrical | 11 | Map Light | 9 |
| Electrical Appliances | 16 | Oven | 19 |
| Electrical Power Supply Cord - 120-volt | 11 | Plumbing | 25 |
| Emergency Starting Switch | 9 | Radiator Service | 10 |
| Engine Cooling system | 8 | Range Top | 19 |
| Engine Removal | 11 | Recovery Towing on the Road | 11 |
| Engine Service | 10 | Reference Material | 1 |
| Escape Routes | 28 | Refrigerator/Freezer | 16,20 |
| Extended Storage - Water System | 28 | Starting and Warm-Up | 6 |
| Extended Storage - Kitchen Appliances | 28 | Safety Belts | 6 |
| Extended Storage - Furnace Fan | 28 | Seats, Pedestal | 24 |
| Extended Storage - Electric Step | 28 | Service Satisfaction | 29 |
| Extended Storage - Lights | 28 | Slide Out Room | 8 |
| Extended Storage - Auxiliary Battery Disconnect .. | 28 | Smoke Detector | 28 |
| Fire Extinguisher | 28 | Storage | 24 |
| Fresh Water | 21 | Tire Chains | 9 |
| Fresh Water Supply - Filling | 21 | Vehicle Identification Number | 1 |
| Fresh Water Use | 22 | Waste Tank - Do's and Don'ts | 23 |
| Fuel (LP and Gasoline) | 7 | Waste Water System | 23 |
| Furnace | 19 | Water Heater | 20 |
| Fuse Replacement | 9 | Water Supply - External | 21 |
| Fuses - 12-volt | 17 | Water System - Troubleshooting | 21 |
| Generator | 12 | Water System - Winterizing | 21 |
| Generator Fuel | 12 | Water Tank - Sanitizing | 22 |
| Generator Power Plant System Service | 10 | Weighing | 2 |
| | | Windshield Defrost - Comfort Control | 9 |

Rev. 7-99