

1997 thru 2004

VIKING[®]



RECREATIONAL VEHICLES

CAMPING TRAILER

OWNER'S MANUAL

ALL WEIGHTS ARE APPROXIMATE and provided to assist the operator in the proper loading of this vehicle.
**CONSULT OWNER MANUAL(S) FOR SPECIFIC WEIGHING
INSTRUCTIONS AND TOWING GUIDELINES**

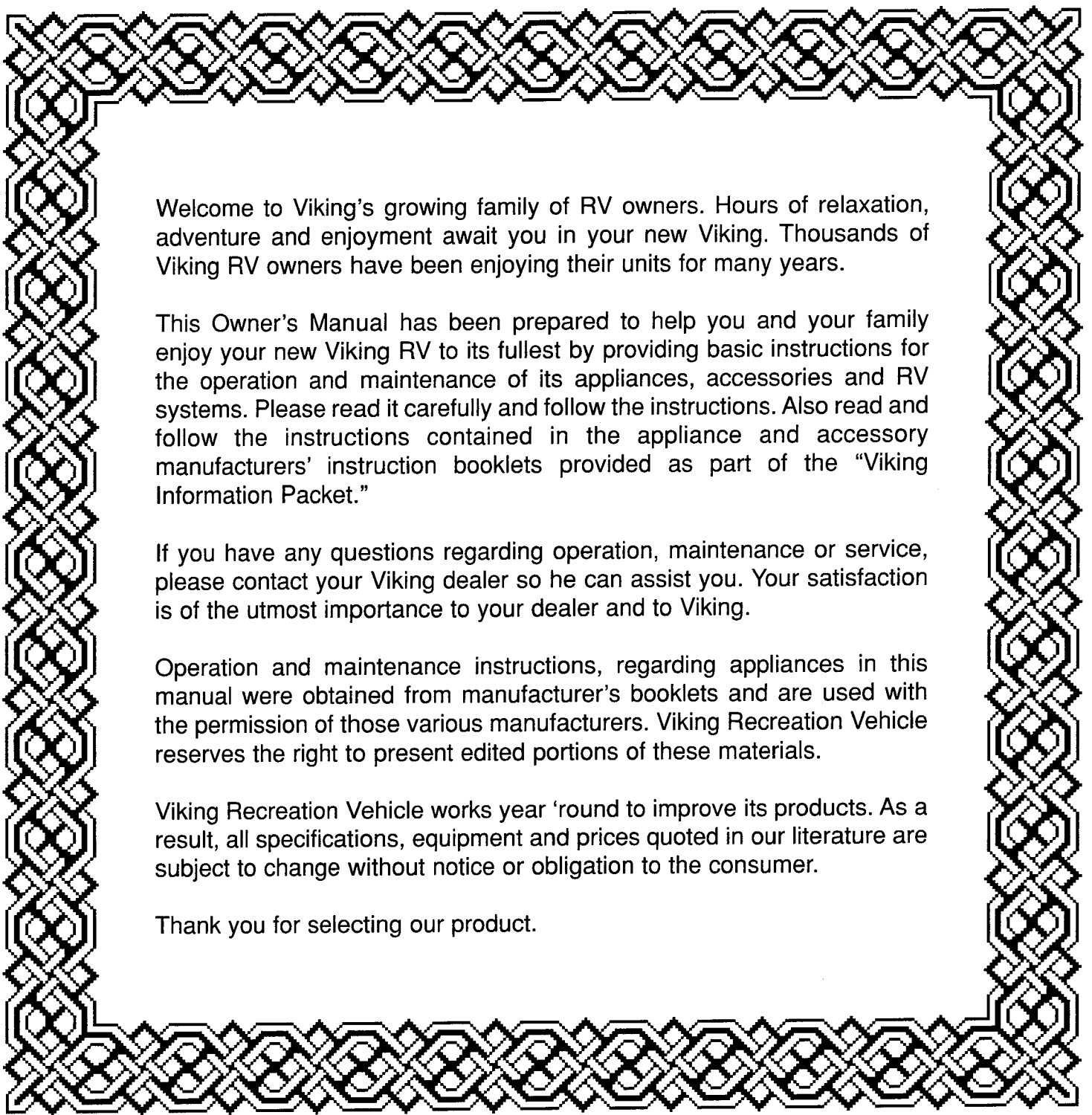

Welcome to Viking's growing family of RV owners. Hours of relaxation, adventure and enjoyment await you in your new Viking. Thousands of Viking RV owners have been enjoying their units for many years.

This Owner's Manual has been prepared to help you and your family enjoy your new Viking RV to its fullest by providing basic instructions for the operation and maintenance of its appliances, accessories and RV systems. Please read it carefully and follow the instructions. Also read and follow the instructions contained in the appliance and accessory manufacturers' instruction booklets provided as part of the "Viking Information Packet."

If you have any questions regarding operation, maintenance or service, please contact your Viking dealer so he can assist you. Your satisfaction is of the utmost importance to your dealer and to Viking.

Operation and maintenance instructions, regarding appliances in this manual were obtained from manufacturer's booklets and are used with the permission of those various manufacturers. Viking Recreation Vehicle reserves the right to present edited portions of these materials.

Viking Recreation Vehicle works year 'round to improve its products. As a result, all specifications, equipment and prices quoted in our literature are subject to change without notice or obligation to the consumer.

Thank you for selecting our product.

**The following note is added as a requirement of the
National Highway Traffic Safety Administration (NHTSA).**

If you believe that your vehicle has a defect which could cause a crash or could cause injury or death, you should immediately inform the National Highway Traffic Safety Administration (NHTSA) in addition to notifying Viking Recreational Vehicles, L.L.C.

If NHTSA receives similar complaints, it may open an investigation, and if it finds that a safety defect exists in a group of vehicles, it may order a recall and remedy campaign. However, NHTSA cannot become involved in individual problems between you, your dealer, or Viking Recreational Vehicles, L.L.C.

To contact NHTSA, you may either call the:

Auto Safety Hot-Line toll-free at:

1-800-424-9393

(or 366-0123 in Washington D.C. area)

or write to:

**NHTSA
U.S. Department of Transportation
Washington, D.C. 20590**



**A symbol which means
BE ALERT!
YOUR SAFETY IS INVOLVED!**

You can also obtain other information about motor vehicle safety from the Hot-Line.

TABLE OF CONTENTS

INTRODUCTION	2	LP Gas Line Check.....	19
WARRANTY		Filling the LP Gas Bottle.....	19
Warranty Service.....	3	LP Bottle Care.....	19
Warranty Period.....	3	Regulator Pressure.....	20
Who is Covered.....	3	LP Gas Regulator Freeze-Up.....	20
What is Covered.....	3	APPLIANCES AND ACCESSORIES	
What is Not Covered.....	3	Range.....	20
Other Warranties.....	3	Ice Box.....	21
Owner Relations.....	3	3-Way 12V/110V/ Gas Refrigerator.....	21
LP GAS SYSTEM SAFETY REGULATIONS	5	Furnace.....	22
TOWING HOOK-UP		Water Heater.....	22
Coupler.....	6	LP GAS BOTTLE INSTALLATION - DOUBLE	23
3-Way Tongue Jack.....	6	LP GAS BOTTLE INSTALLATION - SINGLE	24
Safety Chains, Electrical Connection.....	6	MAINTENANCE	
Hitch Ball Height.....	6	Condensation.....	25
Definitions.....	6	Canvas.....	25
Federal Sticker.....	6	Interior Maintenance.....	25
LOADING		Air Quality.....	25
Weight Distribution.....	6	Roof.....	26
Weighing.....	7	Body.....	26
TOW VEHICLE SELECTION		Frame.....	26
Engine Size.....	8	Electric Brakes.....	26
Load Carrying Hitch.....	8	Wheel Bearings.....	26
Brake Control.....	9	Lift System.....	26
Licenses.....	9	STORAGE	
Insurance.....	9	LP Gas System.....	26
DRIVING		Water Tank.....	26
Pulling into Traffic.....	9	Electric System.....	26
Turning.....	9	Exterior.....	26
Passing.....	9	WINTERIZATION	26
Braking.....	9	FIRE SAFETY	27
Upgrades.....	9	VISITING CANADA OR MEXICO	
Downgrades.....	9	Vehicles.....	27
Emergency Stopping.....	9	CB Radios.....	28
Swaying or Fishtailing.....	9	Hunting and Fishing.....	28
Parking on a Grade.....	9	Dogs and Cats.....	28
Backing.....	10	TOURIST INFORMATION	28
Freeing a Stuck Vehicle.....	10	TROUBLE SHOOTING	29
Spare Tire Rack.....	10	MAINTENANCE	30
LIFT SYSTEM SET-UP	10	APPLIANCE IDENTIFICATION FORM	34
LIFT SYSTEM TAKE-DOWN	15	E-Z POWER LIFT SYSTEM	34
WINDOW CURTAINS	16	TRAVEL PREPARATIONS	35
BASIC UTILITY SYSTEMS	16	PRE-TRAVEL CHECK	35
ELECTRICAL		CODE OF ETHICS	37
120-Volt System.....	16	TRAVEL RECORD	39
Shoreline Connection.....	17	EMERGENCY CONTACTS	40
12-Volt System.....	17	GENERAL INFORMATION	41
Converter.....	17	CAMPING	41
FRESH WATER SYSTEM		REPORTING SAFETY DEFECTS	42
City Water.....	17	ANNEX A - MAINTENANCE	43
Water Tank.....	17	ANNEX B - LP GAS DETECTOR	44
Sanitizing Water Tank.....	18	LP GAS DETECTOR WARRANTY	46
Water Pump.....	18	GAS BOTTLE/BATTERY RACK	
Galley Hand Pump.....	18	INSTALLATION SHEET	47
Sink.....	18	ENTRANCE DOOR SETUP INSTRUCTIONS	49
Leaks.....	18		
DRAINAGE SYSTEM			
Drainage.....	18		
LP GAS SYSTEM			
Climate Differences.....	19		

INTRODUCTION

Congratulations on the purchase of your new RV. We sincerely thank you for choosing our product. To help you enjoy your new RV, you'll find in this owner's manual many useful tips for camping trips as well as basic operation and maintenance information for your RV's systems and appliances.

TRY A SHORT TRIP FIRST. The experience you'll gain from this will help make your future RVing more enjoyable.

To complement the standard and optional equipment you've chosen for your unit, there are many other accessories available. You may wish to use your unit several times before you invest in these accessories. What may be a necessity for one RVer could prove to be of no value to you. Remember, your dealer is always ready to help and advise you.

We go into great detail in this manual and for good reason. If you are a first-timer, we want you to learn to operate your RV correctly, to be able to use its components, appliances and any optional equipment in the most efficient manner.

At first glance, you may be overwhelmed by all the detail. But after you've used your new RV a couple of times, you'll be able to perform all the checks, start-ups and systems in much less time than it takes to read our instructions.

If you're a veteran RVer, you know that things change and a quick review of this manual will bring you up-to-date on what's new.

So read on. Happy camping!

NOTE:

Because of the variety of models we offer, your RV may not have all of the components illustrated or described in this owner's manual. Ask your dealer for details concerning the specifics of your unit.

Your camping trailer is designed to provide temporary shelter. Its systems and materials are meant to provide reasonable comforts in reasonable environments. Extremes in usage such as prolonged and continuous exposure to the elements while set up, overloading, traveling over severe terrain, or other misuses will overtax the camper, its materials and its overall design. The failure to perform regular maintenance such as gentle cleaning, lubrication, proper tire inflation, and LP systems maintenance will reduce the proper performance of your camper.

⚠ WARNING!
READ THIS MANUAL CAREFULLY BEFORE YOU TAKE YOUR FIRST TRIP
READ WARNINGS ON LP GAS SYSTEMS PAGE

OUR WARRANTY

GENERAL

Your new recreational vehicle is backed by our position as an industry leader, achieved through decades of experience in producing RV's noted for their quality and dependability. Our one-year warranty demonstrates our confidence in our products and is a commitment to customers' continued satisfaction.

Every effort has been made to provide you with a safe, dependable recreational vehicle. Your RV complies with applicable federal and state regulations and the requirements of ANSI A119.2, the nationally recognized "Standard for Recreational Vehicles - Installation of Plumbing, Heating and Electrical Systems." The Recreation Vehicle Industry Association (RVIA) periodically inspects our production and assists in maintaining strict compliance with installation and safety standards for those systems. Similar periodic inspections of the systems are made by representatives of various states. You, the owner, must perform periodic inspections of the systems and provide a program of preventive maintenance as described in the Owner's Manual and instruction booklets.

WARRANTY SERVICE

We recommend that warranty service be performed by the authorized dealer from whom you purchased your RV because of the dealer's continued and personal interest in your satisfaction. But if you are traveling or in the event that you move, service under the warranty will be performed by any of our authorized dealers. Whenever possible, make an appointment to avoid unnecessary delays.

Always carry your Owner Registration Card, which must be presented to obtain warranty service. The card is proof of purchase and provides the date of retail sale, which is necessary to determine warrantability. If you cannot locate an authorized dealer, contact our Service Department at the address on the back of this manual.

WARRANTY PERIOD

The warranty period shall be for 12 months and begin on the date the new recreational vehicle is delivered to the retail purchaser, or the first in-service date, whichever is first.

WHO IS COVERED

The first retail purchaser, provided terms of the warranty are met.

WHAT IS COVERED

The Manufacturer warrants to owners that an authorized dealer or Service Center will make repairs made necessary by defects in material or workmanship during the warranty period. Such repairs will be made without charge for parts and labor to the owner.

WHAT IS NOT COVERED

Our warranty does not cover the tires, tubes, repairs or adjustments required because of neglect, accident, misuse, failure to follow service and use instructions, normal wear and/or exposure, unauthorized repairs or modifications to any part of the systems or body that might cause defective performance.

Your new recreational vehicle is designed as a temporary living quarters for recreational camping, travel or seasonal use and not as a permanent dwelling place. Usage as a permanent accommodation is breach of warranty and we are not liable for any damage that results because of such misuse.

The manufacturer does not assume responsibility for loss of use of the recreational vehicle, loss of time, inconvenience or expenses due to equipment failures (refer to the warranty statement for other exclusions and limitations).

Torn vinyl and screens will not be covered under this warranty on units which remain in dealer stock after six (6) months.

OTHER WARRANTIES

Be certain to complete and submit to the appropriate manufacturers the warranty forms for tires, which are not covered by our one-year warranty. If service or parts are required for these products, refer to the furnished list of factory-authorized service centers. If the list is not available, write or call the manufacturer concerned to obtain the location of the nearest authorized service center.

OWNER RELATIONS

Owner satisfaction and good will are of primary concern to us. We recognize that our continued success as a leading manufacturer of recreational vehicles depends upon your complete confidence in our products and service. A pleasant and effective relationship through our dealers is as important as maintaining the technical excellence of our product. Your authorized dealer will assist you in providing service, maintenance, selection of options and instructions concerning the operation of your recreational vehicle.

Occasionally, a warranty or service matter may not be handled to your satisfaction. Often it is the result of a misunderstanding and can be resolved at the dealer level. Discuss the situation with the dealership management. If you cannot find satisfaction at the dealer level, we invite you to contact our Service Department, where we will make every effort possible to provide an agreeable solution. In most instances, we will eventually refer you back to the local dealer with our recommendations.

Write or telephone our Service Department at the address or telephone number at the back of this manual.

SERIAL NUMBER, DECALS AND DATA PLATES

The camping trailer serial number label is mounted on the front road side of the camper and stamped into top of "A-Frame."

IMPORTANT

Always give model, year and serial number information when ordering parts. Also VIKING recommends that you keep a copy of this information separate from the camper in the event theft or vandalism requires you to supply a copy to the authorities.

Decals and date plates used throughout the camper aid in its safe and efficient operation; others give service instructions. Read all decals, data and instruction plates before using your new camper. When any decal, data or instruction plate is damaged, painted over, removed, etc.; it should be replaced.

MANUFACTURER'S WARRANTIES

The following list of manufacturers has been compiled to help you know which products on your camping trailer may have their own warranties. If you have any of these components on your camping trailer, be sure to check the literature supplied by the manufacturer to see if they require that you register your purchase with them to validate their warranty. These warranties usually apply only to the first owner of the camping trailer. VIKING recommends that you send the various warranty registration cards immediately before any time constraints on registration expire. Manufacturer's literature is contained in a separate packet furnished with the owner's manual on newly delivered units. Only those products and options which are on your camper will be included in this packet. You should go over this literature with your dealer during the pre-delivery inspection. Any shortages of literature should be reported to dealer at that time.

APPLIANCES

Range Suburban
Refrigerator Dometic

ELECTRICAL

110V / 12V Converter WFCO

WATER & DRAINAGE

Galley Pump..... JC Water System
Water Heater Suburban
Toilet..... Thetford

LP GAS

Regulator Fairview
Furnace Suburban

MISCELLANEOUS

Axle..... Dexter
Tires / Wheels..... Americana Tire

SAFETY

THE SAFETY ALERT SYMBOL  IS USED THROUGHOUT THIS MANUAL TO CALL ATTENTION TO WARNINGS WHERE VEHICLE DAMAGE OR POSSIBLE PERSONAL INJURY MAY BE INVOLVED.

⚠ WARNING!

SAFETY REGULATIONS REGARDING LP GAS SYSTEMS AND LP GAS APPLIANCES

The manufacturer of this recreational vehicle is required to furnish the following consumer information as provided by the National Fire Prevention Association and the American National Standards Institute. The information and warnings found here may also be found in other sections of this Owner's Manual. Please see sections titled "Liquid Petroleum Gas System" and "Appliances" for other safety and operating information.

⚠ WARNING!

LP gas containers shall not be placed or stored inside the vehicle. LP gas containers are equipped with safety devices which relieve excessive pressure by discharging gas to the atmosphere.

⚠ WARNING!

It is not safe to use cooking appliances for comfort heating. Cooking appliances need fresh air for safe operation. Before operation:

1. Open overhead vent
- or*
2. Open window

This Warning Label has been located in the cooking area to remind you to provide an adequate supply of fresh air for combustion. Unlike homes, the amount of oxygen supply is limited due to the size of the recreational vehicle, and proper ventilation when using the cooking appliance(s) will avoid dangers of asphyxiation. It is especially important that cooking appliances not be used for comfort heating as the danger of asphyxiation is greater when the appliance is used for long periods of time.

⚠ WARNING!

Portable fuel-burning equipment, including wood and charcoal grills and stoves, shall not be used inside this recreational vehicle. The use of this equipment inside the recreational vehicle may cause fires or asphyxiation.

⚠ WARNING!

Do not bring or store LP gas containers, gasoline, or other flammable liquids inside the vehicle because a fire or explosion may result.

A warning label has been located near the LP gas container. This label reads:

DO NOT FILL CONTAINER(S) TO MORE THAN 80 PERCENT OF CAPACITY.

Overfilling the LP gas container can result in uncontrolled gas flow which can cause fire or explosion. A properly filled container will contain approximately 80 percent of its volume as liquid LP gas.

The following label has been placed in the vehicle near the range area:

IF YOU SMELL GAS:

1. Extinguish any open flames, pilot lights and all smoking materials.
2. Do not touch electrical switches.
3. Shut off the gas supply at the tank valve(s) or gas supply connection.
4. Open doors and other ventilating openings.
5. Leave the area until odor clears.
6. Have the gas system checked and leakage source corrected before using again.

LP gas regulators must always be installed with the diaphragm vent facing downward. Regulators that are not in compartments have been equipped with a protective cover. Make sure that regulator vent faces downward and the cover is kept in place to minimize vent blockage which could result in excessive gas pressure causing fire or explosion.

TOWING HOOKUP

COUPLER

Release and lift the coupler lever (as shown below). Crank the jack clockwise to lower the coupler onto the hitch ball. Be certain that the coupler is fully seated on the hitch ball. Finish the connection by pushing the coupler lever down until it latches securely. **(Required, an RV safety pin at minimum.)** For theft protection, you may purchase a padlock or similar locking device to insert through the coupler lever, after attaching the coupler to the hitch ball.

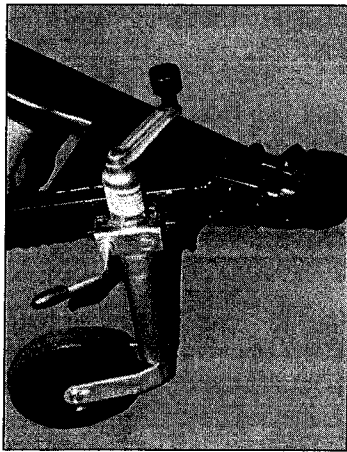

3-WAY TONGUE JACK

To raise the 3-WAY TONGUE JACK assembly, unscrew release lever. Raise the jack up as far as possible. Tighten release lever. Crank jack clockwise to raise dolly wheel.

To remove jack, unscrew release lever until outer half of bracket swings open. Remove jack and close bracket. Screw in release lever.

⚠ WARNING!

NOTE:

Securely tighten tongue jack in place prior to raising or lowering unit. Failure to properly tighten tongue jack could cause jack to slip and cause damage or injury! Never unscrew release lever until front of unit is securely blocked or hitched to tow vehicle.

SAFETY CHAINS, ELECTRICAL CONNECTION

Cross the safety chains under the "A" frame and attach them to the tow vehicle's hitch platform. Plug the tow vehicle's electrical harness into the camper's pigtail connection. Leave enough slack in the chains and pigtail to permit the unit to turn freely. Safety chains shall not be touching the ground.

HITCH BALL HEIGHT

When the loaded trailer is hitched to the tow vehicle, check the hitch ball height. It can be determined by measuring from the top of the curved portion of the coupler to the ground. A high hitch will transfer the weight behind the axle, causing the unit to fishtail. A low hitch will transfer additional weight to the hitch. See page 29 for proper hitch ball height.

DEFINITIONS

GAWR - The allowable weight, including cargo, which can safely be supported by the axles / tires.

GVWR - The maximum permissible weight of your unit, all options, passengers and cargo.

GVW and GAW - are found by weighing the vehicle fully loaded. GVW is the actual weight of the unit and all standard and optional equipment, cargo and passengers. GAW is the portion of the fully loaded vehicle which is transferred to the axle. You can weigh your vehicle at a grain elevator, sand and gravel dealer or government weighing station (they are listed in the yellow pages of your telephone book). The small fee involved is a worthwhile investment.

FEDERAL STICKER

Found on the road side of your camping trailer, the Federal Sticker lists the Viking Serial Number, the Gross Axle Weight Rating (GAWR) and the Gross Vehicle Weight Rating (GVWR). Your tow vehicle also will have a Federal sticker. The ratings are for the specific rim and tire sizes, which are listed.

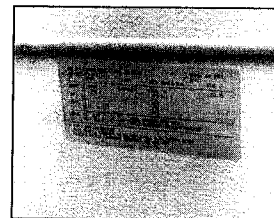

TRAILER WEIGHT INFORMATION

Model _____
GVWR _____
UVW _____
NCC _____

LOAD LIMITS & WEIGHT DISTRIBUTION

Your camper has been designed to carry loads within specified limits. Exceeding these limits will greatly effect handling, safety, and can cause damage to camper components. Load limit and weight distribution terminology is as follows:

- **Gross Vehicle Weight Rating (GVWR)** - This is the total designed weight rating of the camping trailer. It includes everything that combines to give the camper its total weight when traveling. Included are the weight of the camper, all appliances and conveniences, water, LP fuel, and all personal belongings and gear stored both inside and outside. This value must never be exceeded.
- **Gross Vehicle Weight (GVW)** - This is the total loaded weight of the camper, under any given load condition, up to a maximum of the GVWR.
- **Tongue Weight** - This is the weight of the tongue as it bears down on the hitch of the towing vehicle. Tongue weight should be determined with the camper as it would be fully loaded for travel. For stable towing at highway speeds, this weight must be a minimum of 10% and a maximum of 15% of the gross vehicle weight.

- **Gross Axle Weight Rating (GAWR)** - This is the designed weight rating of camper axle when hitched to towing vehicle.
- **Gross Axle Weight (GAW)** - This is the total loaded axle weight under any circumstance, up to a maximum of GAWR. Since a side-to-side load imbalance can occur, each side should be weighed separately also. The weight supported by each side must not exceed GAWR divided by two.
- **Curb Weight** - This is the weight of the vehicle with standard equipment.
- **Unloaded Vehicle Weight (UVW)** - This is the weight of the camper as equipped with options. For our purpose, the unloaded vehicle weight is the weight of the unit with maximum options.
- **Cargo Carrying Capacity (CCC)** - Is equal to GVWR minus each of the following: UVW, full fresh (potable) water weight (including water heater), and full LP gas weight.
- **Net Carrying Capacity (NCC)** - This is the maximum weight of all personal belongings, food, fresh water, LP gas, tools, dealer installed accessories, etc., that can be carried by this trailer. (NCC is equal to or less than GVWR minus UVW).

This trailer is capable of carrying up to _____ gallons of fresh water (including water heater) for a total of _____ pounds. Reference: Weight of fresh water is 8.33 lbs./gal.; Weight of LP gas is 4.5 lbs./gal. (average).

WARNING!

Exceeding the weight ratings of the camper can create a serious safety hazard. Check the weight of your camper frequently as it would be loaded for travel. Remember to take the weight of all liquids into consideration. Also, make sure that the weight is distributed evenly.

The weight ratings of your camper are listed on the weight certification decal located on the roadside of the camper, near the front corner. (See Index: Serial Number Label.)

DO NOT assume that you can fill all tanks and storage areas and be within the GVWR. Weights of stored items will vary greatly and affect the total weight of your camper.

Always give careful consideration when loading your camper so that items will be evenly distributed. It is also important to keep in mind while traveling, that all items stored inside and outside the camper are secure, and all doors and drawers are secure. **DO NOT** add any type of rack or frame to the body or frame. The alteration to length and/or weight distribution may result in unstable handling, be a safety hazard, or could damage camper components. In any case, the camping trailer warranty may be effected.

Always weigh the camping trailer at a certified weigh station equipped with platform scales. Check the telephone directory or with local authorities for the location of weigh stations in your area. Weigh your camper with all equipment, luggage, and fluids on board that you plan to take along. You will need to weigh the unit periodically to assure that you are maintaining correct balance.

To weigh your camper properly, use the following procedure:

1. Level the camper and make sure that it remains level throughout the weighing procedure.
2. For gross vehicle weight, pull the camper onto the scales and weigh with both the axle and front jack resting on the scale. The difference between the weight of the camper fully loaded and empty is the rated personal cargo weight. If for example the GVWR of your camper is listed at 3000 lbs. and it weighs empty at 2200 lbs., your personal cargo weight cannot exceed 800 lbs. The GVW must not exceed the GVWR found on the certification decal.
3. For tongue weight, rest only the hitch on the scale and weigh with the camper fully loaded for travel. Check the weight against the proper tongue weight as listed on the certification decal. The tongue weight must be between 10% and 15% of the GVW for best towing. However, follow the weight recommendations given by the hitch and tow vehicle manufacturers. It may be necessary to reposition your load to obtain correct balance.
4. For gross axle weight, pull forward so that only the camper axle is setting on the scale. If the weight exceeds the GAWR on the weight distribution information sticker, remove or redistribute the weight in the camper to meet the proper specification. The difference between gross vehicle weight and gross axle weight is the tongue weight.

NOTE:

Gross axle weight is determined with both tires on the scale, but side-to-side weight distribution has to be determined by weighing each side separately. The values obtained by weighing each side separately must not exceed the GAWR divided by 2.

Compare scale weights with capacities as shown in the following example:

Gross Vehicle Weight Rating	2200 lbs.
Gross Vehicle Weight	1980 lbs. from Scale
Reserve Capacity	220 lbs.
Gross Vehicle Weight	1980 lbs. from Scale
Gross Axle Weight	1765 lbs. from Scale
Tongue Weight	215 lbs.

CHECK:

GVW multiplied by (.10) = 198 lbs. by (.15) = 297. Compare the range of 198 - 297 lbs. to the actual tongue weight of 215 lbs. to make sure it is within proper limits.

Gross Actual Weight Rating (GAWR) = 2200 lbs.

Left Tire 875 lbs. (Scale Weight)

Right Tire 890 lbs. (Scale Weight)

Compare actual weights for right and left tires to GAWR (2200 divided by 2 = 1100 lbs.) Side-to-side balance should be as equal as possible. A maximum of 25 lbs. difference is acceptable. The GVWR, GAWR, and the recommended 10% to 15% tongue weight must not be exceeded under any circumstances.

TOWING - Continued

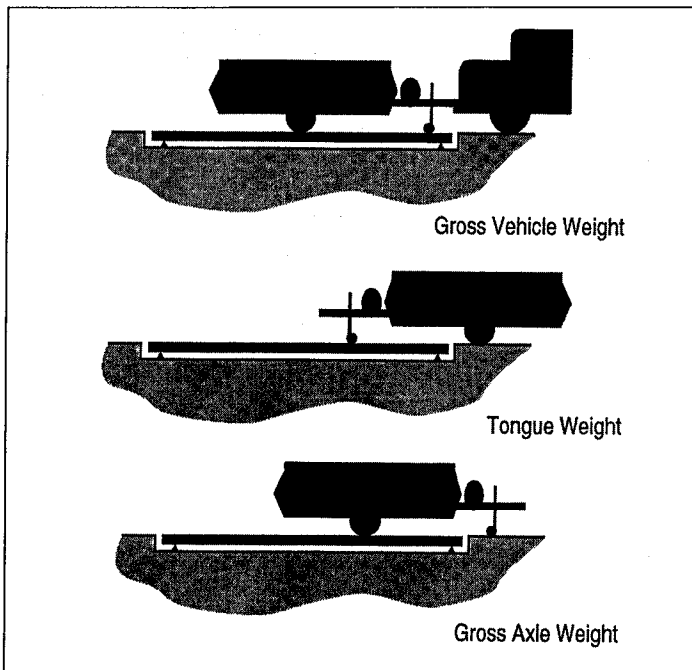

If additional items must be added to the unit after it has been weighed and the loading analysis completed, the following method may be used to prevent overloading:

1. Weigh each additional item using a bathroom scale before placing them in the camper. The total of these items are then added to the GVW originally determined.
2. The tongue weight must then be re-calculated using the new GVW as shown in the sample calculation.
3. The bathroom scale can be placed under the jack with the camper level, and the tongue weight read directly from the scale. The scale reading must fall within the bounds determined previously. The tongue weight can be increased by moving cargo forward, and decreased by moving cargo rearward. However, too much weight in the rear can cause trailer sway or handling instability.

Once you become familiar with loading your camping trailer and know how to distribute the weight and which items you normally carry, make a list and diagram you can use for future reference. Plan your loading and storage so that emergency items are easily accessed. Place heavier or breakable items on the camper floor for greater load stability. Make sure these items are well packed and secured to prevent movement. Take extra care not to overload the front and rear ends of the camper.

Make sure to use packing material around breakable items such as plates and glasses in cupboards if you will be towing over rough roads or terrain. It is a good idea to use non-skid materials under heavier items to help prevent shifting.

Most new camping trailer owners tend to carry more supplies than they really need. It is important to remember that each item added brings with it the extra weight to tow and distribute.

⚠ WARNING!

DO NOT store LP gas containers, gasoline, or other flammable liquids inside the camper because a fire or explosion may result.

⚠ WARNING!

CAUTION: Extending the rear bumper or adding rear supports to carry tool boxes, bikes, motorcycles or other heavy equipment may seriously overload the trailer brakes, axle, wheels and tires. In addition, rear-end load reduces the hitch weight and can cause severe fishtailing. **NEVER EXCEED THE GAWR FOR YOUR UNIT. NEVER TOW WITH LESS THAN 10% OF THE TRAILER GROSS WEIGHT ON THE HITCH.**

TOW VEHICLE SELECTION

GENERAL

Selection of an adequate tow vehicle is essential. If you plan to use a vehicle you already own, refer to the owners manual to determine towing capability.

If you will be purchasing a new tow vehicle, be certain to tell your dealer the type and size of the RV you will be towing.

ENGINE SIZE

The engine size must have enough horsepower to handle the tow vehicle, passengers, Viking unit and all its cargo. Most automobile manufacturers offer a trailer towing package which may include: large alternator and battery, heavier duty tires, side view mirrors, heavier electrical wires, larger engine and transmission cooling systems. Consult the tow vehicle manufacturer's owner's manual for recommendations.

NOTE:

The use of heavier suspension components (springs, shock, axles) or heavier duty tires DOES NOT increase the weight ratings printed on the tow vehicle's identification or certification plate. The Gross Axle Weight Rating (GAWR) is determined by the components within the axle system with the lowest load carrying capacity.

LOAD CARRYING HITCH REQUIREMENTS

Your camping trailer fits a 2" hitch ball. Ask your Viking dealer about the proper Class of load-carrying hitch to use. The selection of the hitch is important since it affects towing and handling characteristics. Read the information supplied by the hitch manufacturer to achieve best possible performance. The hitch weight for your unit is listed in the specification chart on page 29.

NOTE:

Installation of a Weight-Distributing (Load-Equalizing) Hitch is NOT recommended on any vehicle towing a camping trailer. No Class 2 or 3 load equalizing hitch approved.

BRAKE CONTROL

The electric brake controller, required on models with electric brakes only, automatically activates the brakes on your camper when the tow vehicle's brakes are applied. It provides braking effort directly proportional to the braking action of the tow vehicle.

This is an item that must be purchased additionally as it is not supplied with the camper from the manufacturer or automatically supplied by your dealer at the time of purchase. There are several models to choose from including those that install in your towing vehicle and those that may be installed on the A-frame of the camper.

If you are not familiar with them, please contact your dealer for assistance in choosing the correct one to meet your specific needs. Units equipped with safety break-away switch require auxiliary battery mounted to trailer with wiring to activate upon trailer break-away. Refer to your Tow Vehicle Owner's Manual for additional towing/braking instructions.

LICENSES

Vehicle licensing laws vary from state-to-state. Check with your license bureau or nearest branch office for the requirements in your state. Be sure to renew your driver's license if it has or will expire during your trip.

INSURANCE

Personal liability, property damage, collision and theft of contents may be features of your automobile policy which apply to your Viking unit. Contact your insurance agent about details of your coverage. Always carry your proof of insurance.

DRIVING

GENERAL

Your camping trailer has been built to make towing easy, but get to know how your tow vehicle handles with added weight and length of your Viking. Before leaving on a trip, practice turning, backing, braking, and accelerating. You may find a little difference in the operation, but remember to allow extra room for the combined length of the tow vehicle and Viking unit. The following are tips to help you in your driving.

PULLING INTO TRAFFIC

Check for oncoming traffic in all directions. Signal before entering the traffic flow. Accelerate slowly and smoothly.

TURNING

Pull several feet farther into intersections before turning to allow sufficient clearance for the rear of your Viking unit.

PASSING

Avoid sudden maneuvers when passing a slower-moving vehicle. Remember that additional time and distance are required to pass safely. Wait until the road is clear of oncoming traffic for at least 1/2 mile. Check the outside rear view mirrors and signal lane changes before passing other vehicles. When you have safe clearance, signal lane change and return to your original lane.

BRAKING

Allow a safe distance to stop; follow no closer than one combined tow vehicle - Viking unit length for each 10 mph. Pump the brake pedal lightly to stop on wet or icy roads. If you start to slide, turn the steering wheel in the direction of the slide. **DO NOT** "slam on" the brake pedal - a panic stop may increase the slide and could cause your unit to jackknife. Do not rest your foot on the brake pedal while driving. "Riding" the brakes in this manner may cause overheating, excessive lining wear and possible brake failure.

UPGRADES

Reduce speed when climbing a steep upgrade. Shift the transmission to a lower gear to avoid engine overheating. If your engine does overheat, consult your tow vehicle owner's manual.

DOWNGRADES

Speed should be reduced; shift the transmission to a lower range to assist in braking on long or steep downgrades.

EMERGENCY STOPPING

DO NOT slam on the brakes if the coupler disconnects from the hitch - the camper may strike the tow vehicle. Steer toward the shoulder of the road and gradually reduce speed. The safety chains, which must be crossed under the coupler and hooked to the hitch platform, will prevent the tongue from dropping to the road.

SWAYING OR FISHTAILING

If your unit sways or fishtails, accelerate, then gradually slow down. If you have a manual brake controller, apply only the brakes of your camping trailer. If your unit is still swaying, pull off the road and check tire pressure, cargo location, or tow vehicle front end alignment, suspension and lug nuts.

PARKING ON A GRADE

Parking vehicles on a grade is not recommended. If it is necessary, apply the brakes and have passenger place wheel chocks against the tires of your Viking unit. When in place, slowly release brakes until unit is stopped by chocks. Apply parking brake and place transmission in park position (place in gear for stickshift vehicles).

DRIVING - Continued

BACKING

When backing your camping trailer, place your right or left hand at the bottom of the steering wheel. To move your trailer to the left, move your hand to the left; to move the trailer to the right, move your hand to the right. If the trailer starts to jackknife, stop, pull forward and start again. You may want to station someone behind the unit to help guide you.

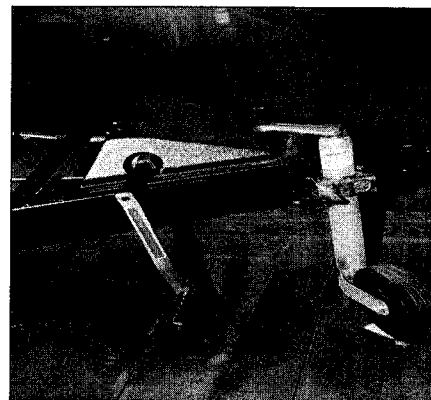
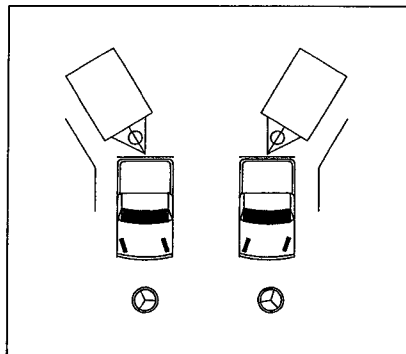

4. Release tongue jack clamp and slide jack assembly down so wheel touches ground. Re-tighten clamp and rotate jack handle counter-clockwise to lift coupler up off hitch ball.
5. Move the tow vehicle or trailer to allow access to the front of the trailer to complete the setup.
6. Rotate jack handle clockwise until front end is slightly lower than rear.

** See Annex A for maintenance*

7. To operate B.A.L. Jacks—Remove black crank handle from unit and place socket end on the end of the jack and adjust as necessary. Several pieces of 6 x 6 x 1/2 (or thicker) plywood are recommended as part of your camping gear. In some cases it may be necessary to place more than one piece of plywood under jack foot for added stability.

FREEDING A STUCK VEHICLE

To pull your unit out of the mud, sand or snow, apply light pressure on the accelerator pedal and move the gear selector rhythmically between first gear and reverse. If possible, keep front wheels pointed straight ahead. Avoid sharp turns which could cause the unit to jackknife. Once you start to move, do not stop until the tow vehicle and camping trailer are on firm ground.

CHANGING A TIRE

Change a tire on as level and firm a surface as possible. If you are on the roadside, activate the unit's hazard warning flashers. Set up flares and/or warning lights. Block opposite tire. Place scissors-type or hydraulic jack on a block of wood directly **UNDER THE FRAME**, just behind the axle. **DO NOT** use a bumper jack; it may damage the sidewalls or the floor board. Raise the jack to take some of the weight off the old tire. Depending on your model you may have to remove a wheel cover. Loosen the lug nuts. Raise the jack until the tire is off the ground. Remove the lug nuts. Replace the flat tire with a spare tire using the same size and load range. Tighten lug nuts. Lower and remove jack. Once again tighten lug nuts. Stop at the nearest service facility and have a torque check on the lug nuts. They should have a torque of 85 - 95 ft.-lbs.

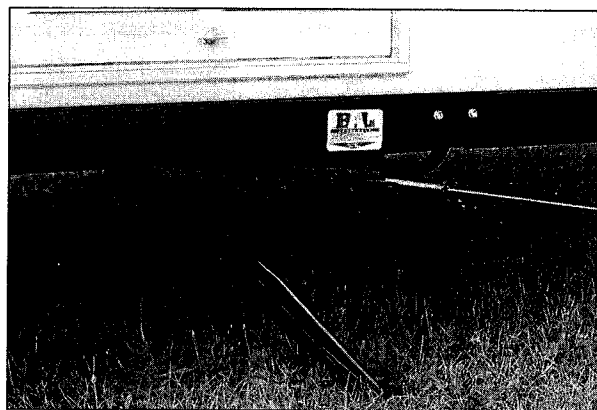

CRANK LIFT SYSTEM

1. Select a level campsite, preferably one without low hanging branches that could damage your camping trailer's top.
2. Position camping trailer for most desirable use of campsite.
3. Unplug car-end wire harness from socket on trailer A-frame, unhook safety chain from tow vehicle, unlatch coupler.

8. Release the two roof latches on each side of the roof (4 latches total).

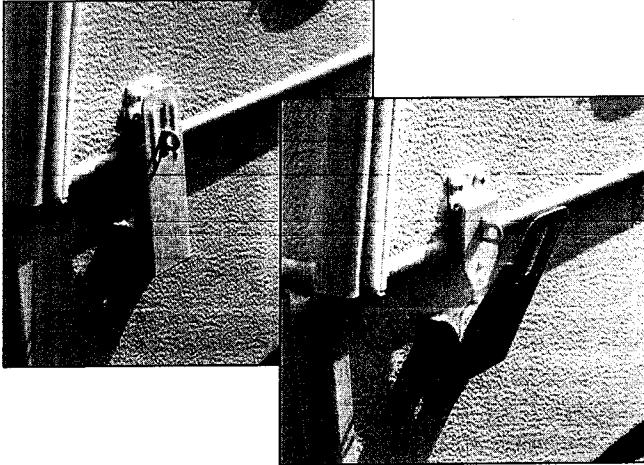

⚠ WARNING!

Lift system damage will result if operation of lift system occurs without total release of all latches.

9. Operation of Lift System:

- a. UNLATCH ALL ROOF LATCHES
- b. Remove the crank handle from storage position and insert crank into the winch located on the front A-frame of the unit.
- c. Turn the crank clockwise to raise the roof and counter-clockwise to lower.
- d. Roof should be raised until the GREEN gauge is taut. (DO NOT OVERTIGHTEN OR DAMAGE COULD RESULT TO LIFT SYSTEM/TENT/ETC.) When the roof is in this raised position, the upper entrance door can easily be lowered into operating position.
- e. When the roof is in the upper position and the upper entrance door installed, remove the two safety channels from their storage areas and place over two of the lift arms. i.e. – Door-side front and off-door-side rear. NOTE: BE SURE TO REMOVE THE SAFETY CHANNELS PRIOR TO LOWERING THE ROOF ASSEMBLY!

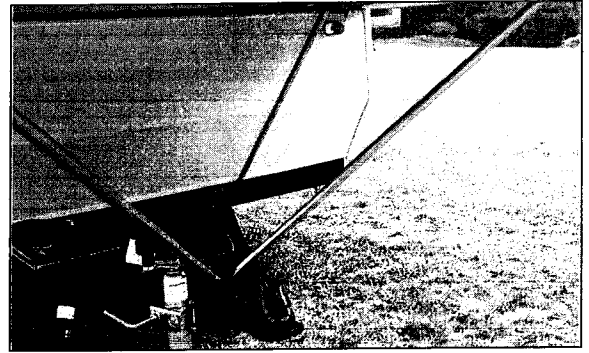

10. ALL Bunks have "A-frame" bunk support arms. Remove the arms from the area from under the bunk matts and place the flat hook end onto the top of the end walls, hooking the hook behind the wall assy. and into the brackets which are placed behind the walls. The leg end of the support brackets now inserts into the slots provided in the frame of the unit. (See illustration.) With the support brackets installed, pull the bunks out to the stops. All front bunks have two additional support poles that install off of the front A-Frame, just behind the hitch coupling. Place the flat end of the single poles into the slots provided in the top of the frame and while lifting the front edge of the bunk, locate the pole into the metal brackets on the bottom of the bunk assy.

11. Insert one pole into each socket on frame of trailer. Pull bunk trays out fully.

⚠ WARNING!

CAUTION: NEVER PULL BUNKS OUT OR PUSH BUNKS IN, UNLESS ROOF IS EXTENDED TO ITS FULL HEIGHT.

12. Lift gently on edge of bunk until the end of the support poles can be hooked onto the tongue of the support plates.

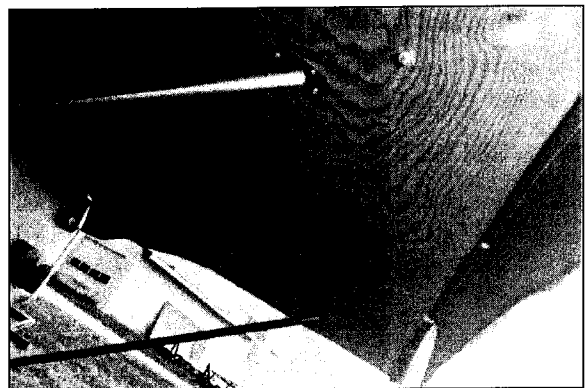

⚠ WARNING!

CAUTION: NEVER ALLOW BUNKS TO HANG UNSUPPORTED, AS THIS WILL CAUSE DAMAGE TO SLIDE ASSEMBLIES.

CRANK LIFT SYSTEM - *Continued*

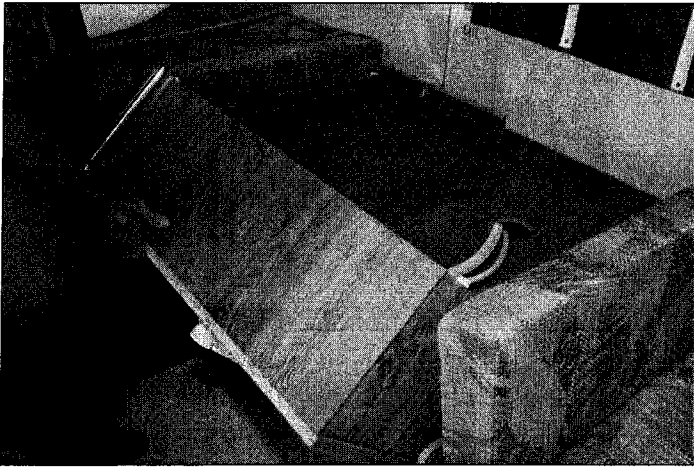

13. Go inside unit, lift flip-over galley into up position. Move galley support leg down behind galley.

14. Close lower door.

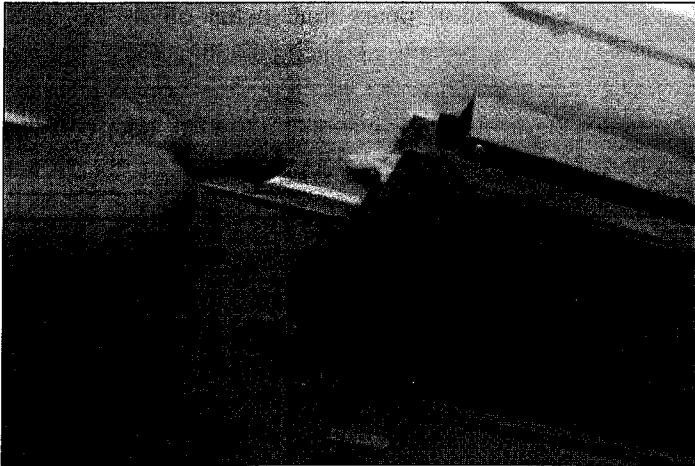

15. While supporting self-storing upper door with one hand, release the two turn buttons that secure the door to the ceiling for travel.

16. Gently swing door down to vertical position.

17. Pull inward on the top of the upper door frame and lift. The door will bend at the top hinged plate.

HELPFUL HINTS:

If door will not open and close properly from outside of the unit, check to see if upper door is square in frame. If not, this may be adjusted by adding or subtracting tension on bunk bows.

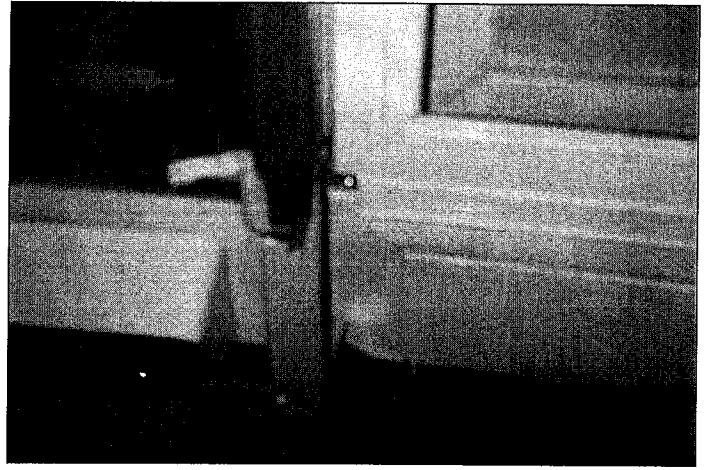

18. Position the bottom of the upper door directly over the lower door and insert the black plastic guide pins into corresponding channels in the lower door frame.

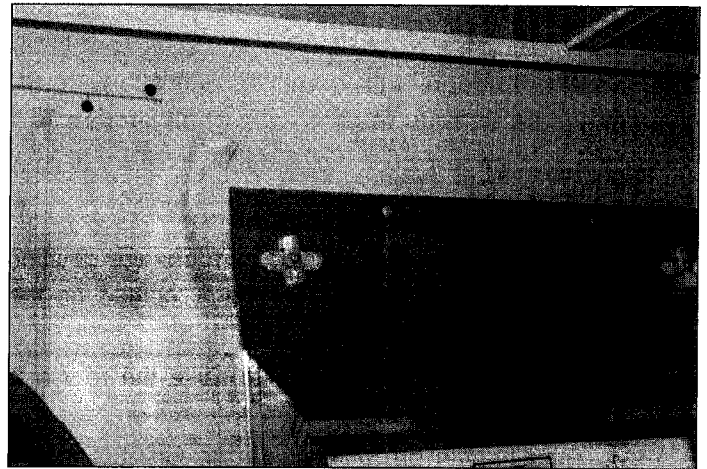

19. Push outward on the top hinged plate until it is flat against the roof side. Secure in position with turn buttons. When door is secured in position, fasten latch between upper and lower door section.

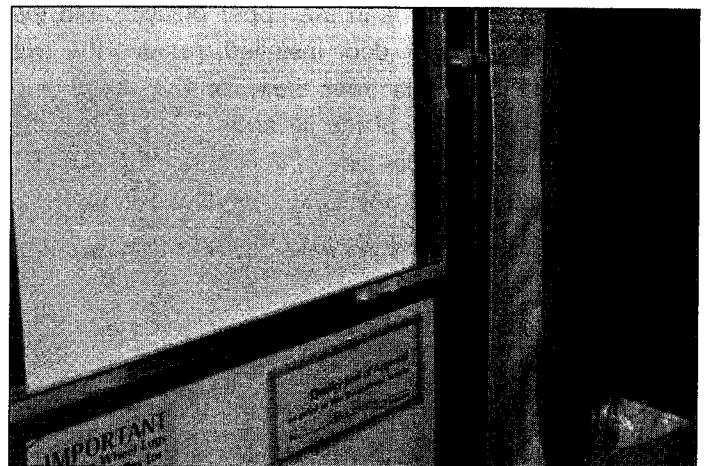

20. Secure the Velcro on the tent to the mating Velcro on the inside of the upper door frame.

OPERATING THE ROLL-OUT SYSTEM:

1. After following the initial setup procedure of raising the roof assembly, installing bunk supports and sliding out bunks.

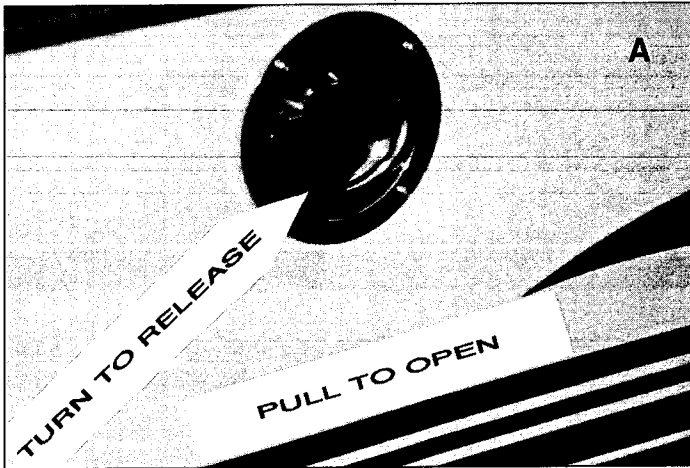

2. On the off-door side of the unit, release the roll-out latch assembly by turning the handle in the center of the roll-out section. (See Ill. A.) This will allow for the roll-out section to be moved out into the camping position. Pull this out until the unit locks firmly into position.
3. Go inside the unit and continue setup, installing the bunk bows and rafters, raising the upper galley. Roll-out section tent setup is basically the same as the bunks. Continue the setup on the roll-out tent section by attaching the velcro flaps, etc. to the roll-out section and the main body of the unit. (See Ill. B.)

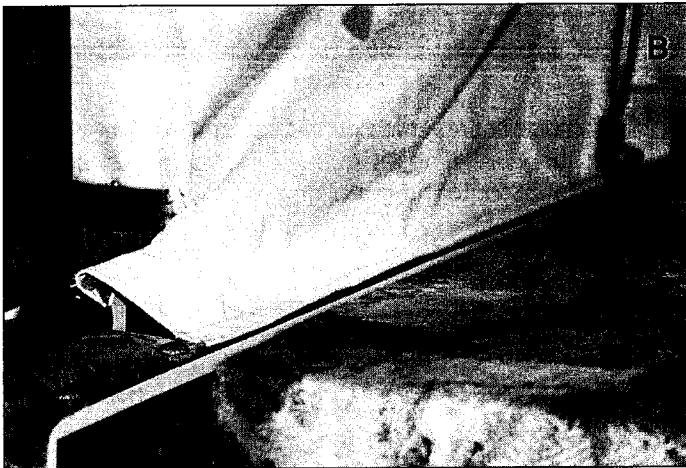

4. To store the roll-out section, after storing the stove/table & cushions, remove the rafter and swing the bunk bow down onto the top of the dinette, undo the velcro flaps and release the locking mechanism on the lower inside corners of the roll-out. (See Ill. C.) To release the locking mechanism, simply push forward on the lock tabs and pull in the corner of the roll-out while repeating the process on the other

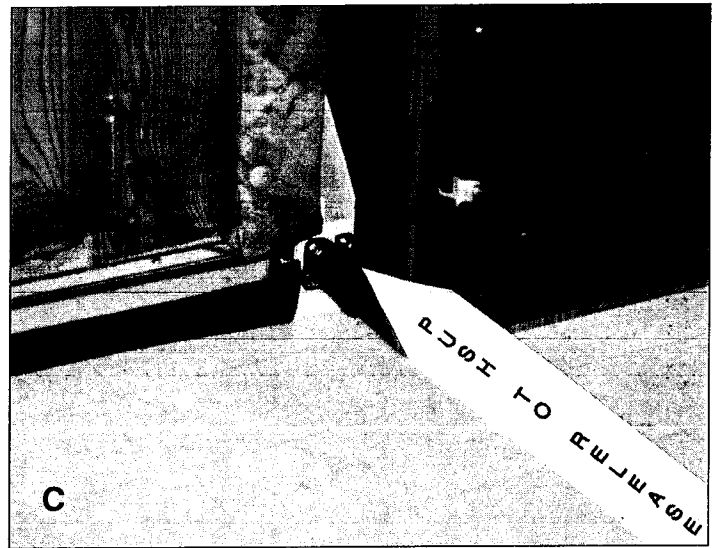

corner. The section will now move inside of the unit. (Check the roll-out tent material to insure that you do not trap the tent material, wiring etc. in the roller mechanism and damage the components!) Return to the off-door side and latch the section into the main body. **NOTE:** Before sliding the bunks back inside, push all of the roll-out tent material to the outside of the unit to keep the bunk from damaging the components. (See Ill. D.)

No warranty claims honored in this area for tents damaged by not following these instructions.



5. Continue storing the balance of the unit as indicated in this manual.

21. Release the turn button on right side of upper door to open door.

⚠ WARNING!

AS THE CANVAS IS PERMANENTLY ATTACHED TO THE BUNK AT THE END ONLY, DO NOT PLACE SMALL CHILDREN OR INFANTS IN BUNK AREA WITHOUT PROVIDING ADEQUATE PROTECTION AROUND OPEN EDGES.

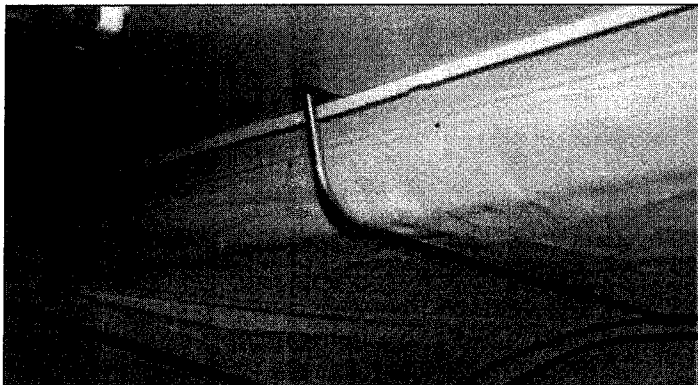

22. Hinged Bow with tension rafter - Remove tension rafter from storage position under bunk mattress. Assemble curved portion and extension as shown and insert stud on extension into hole on face of hinged bow. Carefully push bow outward until bunk top is taut. (Adjust, if needed by snap button and extend to next hole on curved bracket.)



23. Locate elastic cords attached to tent flaps under bunk. Stretch the cords.



24. Unfasten flaps behind the telescoping lift arms. Then stretch out and around to cover the telescoping arms and secure to Velcro provided.

IN/OUT COOKING SETUP

1. After disconnecting the L.P. gas quick disconnect from removable range unit, take the range outside and position cabinet on mounting pins provided on the side of the unit.

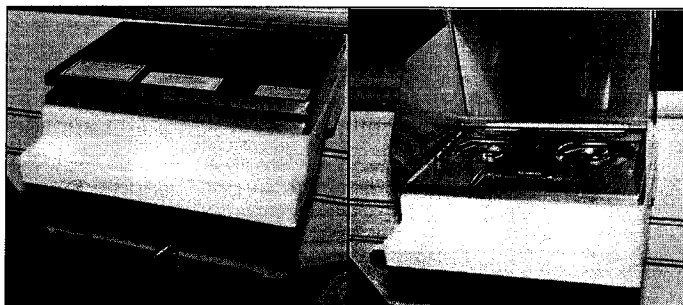

2. Locate mounting studs on side of unit and gently slide onto them. At times it is easier to locate on one pin then rotate onto the remaining pin.

⚠ WARNING!

CAUTION: DO NOT LEAN OR SET ON STOVE! DO NOT OVERLOAD STOVE.

3. Open the adjacent gas hose hatch and pull gas hose with attached quick disconnect out. Then attach range hose to quick disconnect.
4. Open stove cover and unfold windshield wings.

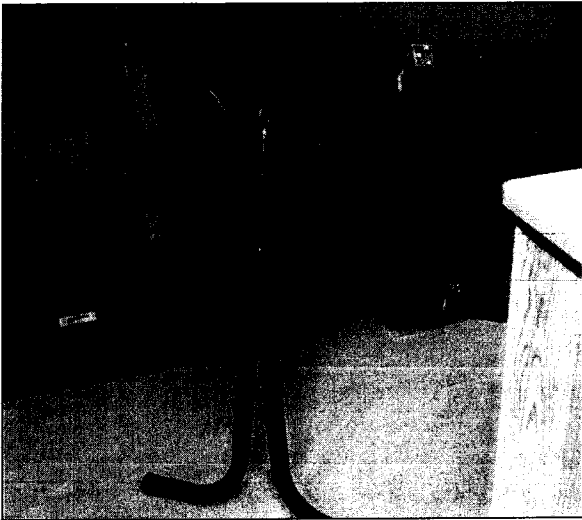

5. Release Velcro straps and unfold legs.

ITEMS TO WATCH IN TAKE-DOWN



When roof is part way down, be certain canvas is folded and tucked to avoid interference with the telescoping lift arms.

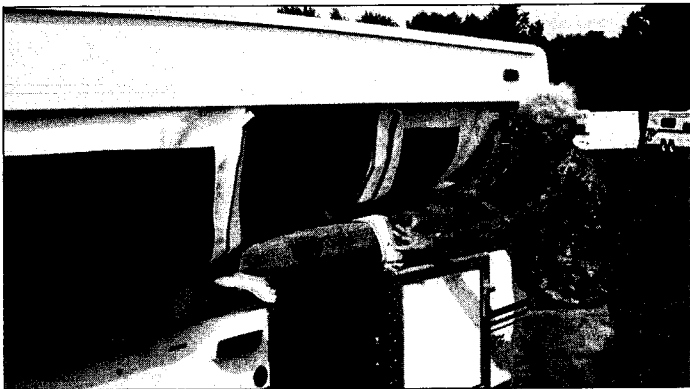

When roof is nearly all the way down, (before latching) tuck canvas into the unit all the way around. Failure to follow these instructions could result in tent damage or leaks around bulb seal areas.

1. WATER SYSTEM

- a. Disconnect water hose from faucet on campsite and city water fill on side of unit.
- b. Replace cap on city water fill to prevent foreign material from entering the system.

2. ELECTRICAL SYSTEM

- a. Check to see that the converter switch is in the "off" position.
- b. Unplug shoreline from the electrical outlet and store. Close electrical hatch cover.
- c. Make sure all lights are in the off position, including storage compartment light.

3. INSIDE / OUTSIDE COOKING GAS SYSTEM (if so equipped)

- a. Turn valve on L.P. tank in clockwise direction until closed.
- b. To completely bleed the lines of gas, light a range burner. When the flame extinguishes, turn range burner off.
- c. Fold in wind guards on stove cover and lower.
- d. Detach quick disconnect under stove.
- e. Carry stove inside unit and place on storage studs found on dinette box under table.

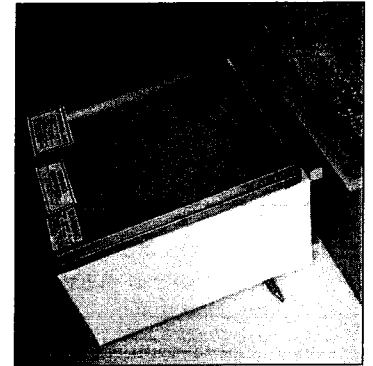

4. DINETTE TABLE (FOLDING LEGS)

- a. Fold table legs and secure with straps.
- b. Secure the table between the dinette seats.
- c. Position dinette cushions on lowered table for travel.

5. DINETTE TABLE (PEDESTAL TYPE)

- a. Remove table top from leg.
- b. Remove leg from floor base.
- c. Store pedestal table leg in dinette seat.
- d. Place table between the dinette seats and position cushions for travel.

6. GALLEY

- a. Flip over
 1. Lift back edge and gently swing over to floor. Be sure to swing fold down support leg (if so equipped) into the travel position.

7. DOOR

- a. Detach velcro strips around both sides of door.
- b. Secure upper door to frame with the turn button on the right side of the door.
- c. Pull inward on the top of the upper door frame.
- d. Raise upper portion of door to the ceiling and secure with turn buttons.

8. BUNKS

- a. Remove tension rafter from slot clip on ceiling and from bunk bow. Store under mattress.
- b. Fold bunk bow down to lay on mattress.
- c. From outside unit, detach elastic cords from under bunks.
- d. Detach support rods from frame and plates under bunk. Store rods under mattress. (Front Only.)
- e. Lift bunk gently and carefully slide into unit. Watch to insure that tent material is not caught on moving bunk.
- f. After bunks are pushed into unit, remove A-Frame supports and store under matts.

WARNING!

CAUTION: REMOVE SAFETY CHANNELS PRIOR TO LOWERING ROOF ASSY.

9. LIFT SYSTEM

- a. Remove crank handle from its storage position. Insert crank handle into winch and turn counter-clockwise.
- b. Stop cranking periodically, and tuck tent fabric into unit.
- c. When roof is completely lowered, secure roof latches on all four corners.
- d. **After securing roof latches, put slight tension on the cables by cranking the handle clockwise one or two turns. This will help prevent in-transit damage.**
- e. Remove crank handle. Return handle to storage area.

NOTE:

Be sure tent is dry before lowering unit. If tent is damp when unit is stored, mildew will form causing damage to the canvas. Return stabilizer jacks to storage position.

WINDOW CURTAINS AND PRIVACY DRAPES

To install curtains, locate the white plastic tabs on top of each curtain panel and snap tabs onto curtain track.

BASIC UTILITY SYSTEM

The basic utility systems in your camping trailer can be classified under four titles - Electrical, Fresh Water, Drainage and LP Gas. This section outlines these systems, describing their operation, function and simple maintenance. It is not intended as a service guide. Your RV has been engineered and built to provide trouble free operation, but should a problem arise, we recommend that you contact your authorized Viking dealer.

ELECTRICAL

GENERAL

Your camping trailer contains two separate electrical systems, providing you with power while you are camped or traveling. There is a 12-volt direct current system, similar to the one in automobiles, and a 120-volt alternating current system, similar to one in homes. Your 120-volt system requires an external source of 120-volt electricity. This is provided by a connection to a campsite receptacle. The 120-volt system should be used whenever a 120-volt hook-up is available to reduce the 12-volt load on your tow vehicle's battery. Power is supplied by the Shoreline connection to the 120-volt receptacles. The 12-volt system is supplied by your automotive battery or the frame mounted or recessed battery pack which may be purchased from your Viking dealer and is used when you are on the road or in campsites which do not provide 120-volt hook-ups. **The interior lights in your camping trailer operate only from a 12-volt source.** Energy is supplied by the automotive battery through the camper's electrical connection, or by the power converter, which changes 120-volt AC into 12-volt DC. Without the converter, the only 12-volt power source to your camper is from the tow vehicle's automotive battery, through the electrical connection.

120-VOLT SYSTEM

The 120-volt system supplies power for the power converter for the 12-volt system and the 120-volt receptacles located in the camping trailer, which are used to operate regular household appliances. (It also provides 120-volt power for an optional three-way refrigerator in certain models.)

When you use the external 120-volt hook-up, the electrical power source is connected directly into the main electrical service panel and is distributed through a circuit breaker.

SHORELINE CONNECTION

The Shoreline is a heavy-duty cable with a three-prong ground plug on one end, permanently attached at the other end to the service panel. It can be pulled from its storage compartment through a hatch in the sidewall of your vehicle and connected to an external receptacle. Some campsites and trailer parks still have two-slot outlets. If it is necessary to use a three-to-two adapter, be certain its grounding wire is fastened securely to the outlet grounding screw. If in doubt, you may attach a No. 6-AWG copper wire to the frame of the vehicle and fasten it to an 8-inch copper or brass stake driven into the ground.

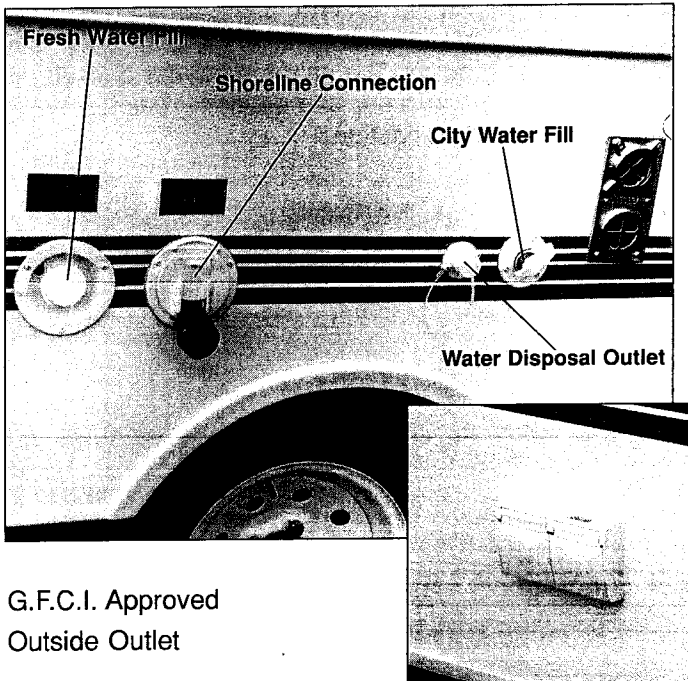

The 120-volt system is protected by a circuit breaker. If the circuit breaker opens, unplug all appliances on the circuit, allow a short period for the breaker to cool, then reset the breaker. If the breaker continues to open, contact your Viking dealer.

12 VOLT SYSTEM

12-Volt energy is supplied by the automotive battery (through the pigtail connection) or the power converter.

The automotive battery and alternator supply 12-volt power to the taillights, brake lights (brakes if so equipped), clearance lights, turn signals, warning flasher lights and 12-volt side of 2-way refrigerator or 3-way refrigerator, if so equipped.

CONVERTER

The power converter transforms 120-volt AC to 12-volt DC. The converter supplies power to all the 12-volt systems, except the refrigerator and vehicular lights. The 12-volt circuit is protected by a fuse in the converter. If the fuse breaks, turn off or unplug all appliances. Replace the broken fuse with one of the same ampere rating. If the fuse continues to break, contact your Viking dealer.

FRESH WATER SYSTEM

GENERAL

Fresh water for your unit is supplied either to the vehicle's fresh water tank or an external pressurized source. Both supply water to the sink.

CITY WATER

Connect a hose to a "city" pressurized water faucet and to the vehicle's water inlet. When using the city water hook-up, the water tank is by-passed. You cannot fill the water tank through the city water inlet. When city water is not being used, tighten cap on city water fill.

⚠ WARNING!

CAUTION: In areas where city water pressure exceeds 60 psi, you should use a pressure regulator. Excessive water pressure may damage lines and connections. See your Viking dealer for further details.

FILLING WATER TANK

Open the gravity water fill by turning cap. Insert a hose to fit the fill spout. Water will flow out the water fill vent when the tank is full.

SANITIZING WATER TANK

Sanitize your unit's water tank before initial use, after a period of non-use and whenever the tank is suspected of being contaminated. Open the drain cock (located either directly on bottom edge of tank or in some instances on a short piece of clear hose for easier access) and drain the water out. When the tank is empty, close the drain cock. Mix three gallons of water with 1/4 cup of liquid household bleach. Pour solution into tank through gravity water fill. Wait three hours. Flush the tank with fresh, potable water. If a chlorine taste lingers, pour one quart of vinegar and five gallons of water into the tank. Wait several days before draining tank. Flush tank with fresh, potable water.

WATER PUMP

The water pump is a 12-volt DC appliance that is activated by a switch mounted in the kitchen area. The switch may be left on while camping. When you want water, simply open a faucet. The pump, which applies water from the fresh water tank, will run only as long as is needed. If the pump fails to start when the switch is on, check the fuse located in the converter. If the pump continues to operate whether the faucets are opened or closed, check the water tank. It might be empty, or there may be a leak in the system. If the city water hose is connected, the pump is not required.

GALLEY HAND PUMP

Water to the galley hand pump faucet is supplied by either the water tank or city water. To draw water, press handle to the down position for city water. A full stroke of the handle activates a hand pump for water from the water tank.

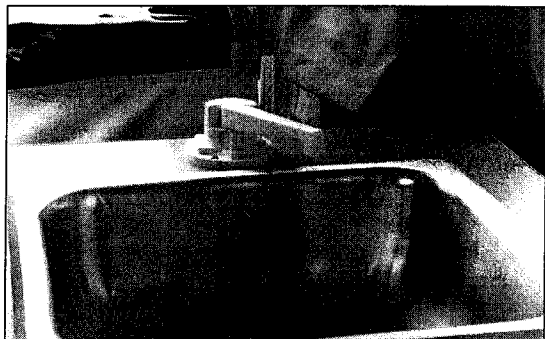

⚠ WARNING!

Do not use hand pump spout as a handle for raising or lowering galley.

NOTE:

When city water is not being used, tighten cap on city water fill.

SINK

Clean the sink with non-abrasive cleanser. Stainless steel cleaner may be purchased at most grocery stores.

LEAKS

Traveling over bumpy or rough roads can cause pipe fittings to loosen. Check pipe fittings regularly for signs of leakage.

DRAINAGE SYSTEM

GENERAL

The drainage system of your camping trailer consists of a sink drain and a drain trap. The latter maintains a water barrier to prevent odors (caused by drain water) from entering the RV.

DRAINAGE

Remove protective cap from drain fixture and attach a garden hose to the outlet. Some campsites will have septic service for the disposal of sink water at each site. If the site is not so equipped, collect water in a bucket or container and dispose of as required by the park rules. To avoid contaminating your water system, use different hoses for fresh and drain water. Hoses of different colors will help you avoid interchanging. The same is true for buckets or vessels used for fresh water and drainage; paint or mark them to prevent contamination.

⚠ WARNING

CAUTION: Do not pour boiling water down the drain as it will damage your flexible drain hose.

⚠ WARNING!

Read the following chapter and safety warnings on Page 5 CAREFULLY.

LP GAS SYSTEM

** See Annex B for LP Detector information*

GENERAL

The Liquefied Petroleum (LP) Gas system in your unit, furnishes fuel for heating and cooking. LP gas is stored in a bottle or bottles on the "A" frame of your unit. Under pressure in the bottle, the LP gas turns to vapor; it is the latter which burns. Each bottle has a 20% vapor level gauge which allows space in the bottle for vapor expansion. The high pressure vapor in the bottle is reduced in two stages through a regulator. The tank pressure will vary with temperature and altitude, but may be 100 pounds per square inch or more. It is reduced to about 12 pounds psi in the first stage, then to about 6-1/4 ounces psi in the second stage. The LP gas is propane or a blend of propane and butane, depending upon your locale.

The LP gas system is designed and built to rigid standards and tested before leaving the factory. Your Viking dealer also tests the system prior to delivery to you. Except for simple maintenance and occasionally tightening a connection, you should take your unit to an authorized Viking dealer for repairs or adjustments. The LP bottle(s) should always be filled by an authorized dealer.

NOTE:

Viking Recreational Vehicles, L.L.C. is not responsible for personal injury or property damage resulting from improperly maintained LP gas appliances and systems. LP gas burns readily and with intense heat.

With proper care and maintenance, it is safe and efficient. However, there are certain characteristics of LP gas of which you should be aware. In its natural state, LP gas is odorless but an additive gives it a distinctive odor so that most leaks may be readily detected.

LP gas is heavier than air and tends to collect in low pockets. **As LP gas settles into any closed area, it displaces air and thus could cause suffocation if not detected. It could also create a fire or explosion hazard.**

The following label has been placed in the vehicle near the range area:

 **WARNING****For your safety, if you smell gas:**

1. Extinguish any open flames, pilot lights and all smoking materials.
2. Do not touch electrical switches.
3. Shut off the gas supply at the tank valve(s).
4. Open doors and other ventilating openings.
5. Leave the area until odor clears.
6. Have the gas system checked and leakage source corrected before using again.

CLIMATE DIFFERENCES

The appliances will not function if the LP gas does not vaporize. Butane will not vaporize below 32°F (the freezing point of water), but propane will continue to vaporize down to -44°F. Propane has become the main type of LP gas used in RV's in recent years. Your LP supplier will have the correct type or blend for your locale. If your travels will take you into an area where climate differs, ask your LP dealer for his recommendations. The names of LP suppliers can be found in the yellow pages of your telephone directory under "Gas-Liquefied Petroleum - Bottled and Bulk." Many campgrounds now have LP gas fill facilities as do some service stations.

 **WARNING!****LP GAS LINE CHECK**

Always check the gas line connection after each refill and inspect other connections regularly, at least every 30 days or 5,000 miles of travel. To check, turn off all burners and pilot lights. Open all doors and windows. Open the LP gas bottle service valve and use soapy water, a bubble solution or approved leak detector to test all line connections. Do not use products that contain ammonia or chlorine. Bubbles indicate a leak. Tighten the connections with two open-end wrenches until bubbles stop. If leak persists, contact your Viking dealer.

FILLING THE LP GAS BOTTLE

Before removing an LP gas bottle, be certain ALL burners and pilot lights are off. Close the service valve and turn the green knob on gas hose counter-clockwise to disconnect the hose from the tank valve. **NOTE: NO TOOLS REQUIRED TO DISCONNECT THE NEW ACME PIGTAIL FROM THE VALVE.** To remove empty LP gas bottles, loosen the bottle clamp and slide the bottle up and out of the bracket. **TRANSPORT EMPTY LP GAS BOTTLES IN AN UPRIGHT POSITION!**

Take your bottles to an authorized LP supplier for filling. He will connect the fill nozzle to the gas line connector. The Service valve and the 20% vapor level gauge must be open. Filling should be stopped as soon as liquid appears at the liquid level gauge. Close the Service valve or the 20% gauge; they are designed to be closed leak-tight by hand. If you cannot hand-tighten properly, the valve may need repair or replacement.

A warning label has been located near the LP gas container. This label reads:

DO NOT FILL CONTAINER(S) TO MORE THAN 80 PERCENT OF CAPACITY.

Overfilling the LP gas container can result in uncontrolled gas flow which can cause fire or explosion. A properly filled container will contain approximately 80% of its volume as liquid LP gas.

Avoid overfilling by insisting that the LP gas bottle is never filled beyond 80% of capacity. If the bottle is overfilled, have the LP gas dealer bleed out the excess. Overfilling does not allow sufficient space for the liquid to expand. This can produce excessive pressure which can cause LP gas leaks, creating potential fire or explosion hazard. **DO NOT smoke, strike a match or ignite a lighter when the LP gas bottle is being filled. A spark or flame could ignite fumes.** Be certain all burner and pilot flames are out and the Service valve is closed when filling your tow vehicle's gasoline tank.

Reinstall a single bottle by placing it in the support brackets, insert the bolt through the bracket. One nut should be tightened until the ring is tight around the gas bottle, then a second nut should be tightened against the first to prevent them from vibrating loose. Reinstall a double bottle on the bottom support plate. Tighten the spinner nut so the "T" bar holds both bottles in place. Reconnect the gas line and check for leaks.

LP BOTTLE CARE

After each trip, inspect the LP gas bottle. Sand off traces of rust and apply a rust preventative paint. When the LP gas system is not in use, the Service valve should be closed.

 **WARNING!**

LP Gas containers shall not be placed or stored inside the vehicle. LP Gas containers are equipped with safety devices which relieve excessive pressure by discharging gas to the atmosphere.

REGULATOR PRESSURE

Each LP gas bottle, or pair of gas bottles, will have a regulator. If you have double 20 lb. bottles, open only one bottle's Service valve. When the bottle is empty, close the Service valve and open the other bottle. You can check the volume of LP gas by weighing the bottle, comparing the known weight of an empty and filled bottle. The Tare (empty) Weight is stamped on the LP gas bottle handle.

Also stamped on the bottle is its water capacity in pounds. Multiply the Water Capacity by .42. The result will be the LP capacity in pounds (allowing for the 20% vapor space). Add the LP weight to the Tare Weight to get the total weight of filled bottle.

EXAMPLE:

If a 20 lb. bottle lists Tare Weight (TW) at 18 lbs. and Water Capacity (WC) at 48 lbs., the weight of the bottle when filled with LP to 80% of its capacity will be 38 lbs. ($48 \times .42 = 20.16$ or 20 lbs. or LP 18 lbs. plus 20 lbs. = 38 lbs.).

LP Gas regulators must always be installed with the diaphragm vent facing downward. Regulators that are not in compartments have been equipped with a protective cover. Make sure that regulator vent faces downward and that cover is kept in place to minimize vent blockage which could result in excessive gas pressure causing fire or explosion.

Check the LP gas regulator at the beginning of each season, or whenever a problem is indicated. Correct line pressure is 11 inches of water column. Your Viking Dealer or LP gas supplier can perform this check.

LP GAS REGULATOR FREEZE-UPS

LP Gas regulator freeze-up is a problem RV owners can prevent if they are aware of its cause. Freeze-up is usually caused by one of three things: moisture in the bottle, an overfilled bottle, or a greater vapor withdrawal demand than the bottle can deliver at a particular temperature. Freeze-ups occur more frequently in cold weather when equipment can freeze and there is a lower rate of vaporization and a higher rate of demand.

Moisture can enter the bottle in the LP gas or through condensation if air is allowed into the bottle through an open valve. Avoid these conditions by using moisture-free LP gas and keeping all bottle valves closed during storage. If moisture is present, have the bottle purged by an authorized dealer and have him add anhydrous methanol; he will know the correct amount for the size of your bottle.

An overfilled bottle can allow liquid gas, instead of vapor, to flow through the regulator. This can result in erratic regulator delivery pressure, improper appliance operation or burner outage, and possible frosting of the regulator and LP gas lines. This can be avoided by following the previously cited precaution about overfilling.

Liquid gas does not vaporize as rapidly in cold weather, so you may place too great a demand on your bottle's capabilities in certain conditions. This can cause a refrigeration effect resulting in frosting of the bottle and

regulator. Check with your Viking dealer or LP supplier about the appliance demand which can be met by your bottle at various temperatures. Always have your LP supplier add anhydrous methanol before filling the bottle in cold weather.

WARNING!

Do not bring or store LP gas containers, gasoline or other flammable liquids inside the vehicle, a fire or explosion may result.

APPLIANCES AND ACCESSORIES

RANGE

GENERAL

Your Viking camping trailer will have a two or three burner range, which is a gas appliance.

LIGHTING THE RANGE

Be certain the LP gas bottle service valve is OPEN. Light a match and hold it close to the range burner, then turn the burner's control knob to full ON.

Air in the line may cause a blowing sound and may extinguish the match. When the line is free of air, the burner should light readily. Adjust the burner flame with the control knob.

WARNING!

It is not safe to use cooking appliances for comfort heating.

Cooking appliances need fresh air for safe operation. Do not use large pans which could restrict the burner efficiency and spread the flame away from the burner and cooktop.

BEFORE OPERATION:

1. Open overhead vent and,
2. Open window.

This warning label has been located in the cooking area to remind you to provide an adequate supply of fresh air for combustion. Unlike homes, the amount of oxygen supply is limited due to the size of the recreational vehicle, and proper ventilation when using the cooking appliance(s) will avoid dangers of asphyxiation. It is especially important that cooking appliances not be used for comfort heating as the danger of asphyxiation is greater when the appliance is used for long periods of time.

CARE OF RANGE

Allow the range top to cool, then clean it with hot, soapy water. Use a damp cloth to clean chrome surfaces. Grease spatters, which may bake onto the surfaces, should be wiped off before they have time to harden. Use chrome polish to remove stubborn stains. Use a toothpick to clean clogged burner orifices. DO NOT use metal objects, such as an ice pick or wire to unclog burners. They may distort the opening and adversely affect burner operation. Read the manufacturers manual for details on the operation and care of the range.

NOTE:

Prolonged use of the range may cause moisture to form on the inside of the canvas and vinyl walls. Condensation may also form on the inside of the camper during heavy rain or when the outside temperature drops. This condition can be controlled by opening a window on the down-wind side of the camper or opening the roof vent.

CARE OF THE REFRIGERATOR OR ICE BOX

Remove food and ice after each trip. Clean interior with warm water and liquid dish soap. Wipe dry with soft, dry cloth. DO NOT use abrasive cleaning material; it will scratch interior surfaces. Prop the door open during periods of non-use.

To defrost refrigerator, remove frozen food and ice. Turn off the thermostat. Place a pan of hot water inside the compartment to speed up the defrosting process. Dry the interior with a clean cloth.

12V / 110 / GAS REFRIGERATOR

The gas and electric controls are located in the rear of the refrigerator and are accessible through the doors in the outside wall of the vehicle. To remove the doors, turn the black buttons on the lower corners 90° counter-clockwise to release.

1. LP Gas Operation - Lighting the burner (see Figures 4 and 8)
 - a. Check that the voltage change switch (A) is at the OFF position, then turn on the gas valve (B) so that its handle (G) is in line with the valve body.
 - b. Turn the gas thermostat knob (C) to setting No. 4.
 - c. Push in the plunger (D) of the flame failure device for about 10 to 15 seconds to clear air from pipeline. (When starting initially, or after changing a gas bottle, it may be necessary to depress the plunger for a minute or longer to clear all the air from the pipes.) Still pressing in the plunger (D), push in the button (E) of the piezo igniter. The burner should light, but continue to press in the plunger (D) for a further 15 seconds then release it and check that the burner is lit by looking at the flame through the

opening (see Figure 8). If the burner has not lit, repeat the lighting procedure. The tray should show signs of cooling after about an hour.

- d. To shut down, turn handle (G) of the gas valve (B) away from the back of the cabinet.

NOTE:

If the gas has to be re-lit when the refrigerator is still cold, the thermostat dial (C) must first be turned to MAX and returned to its normal setting only after the burner is lit. The refrigerator has a flame failure device which will automatically shut off the gas to the burner if the flame is blown out. While the plunger (D) is being held in, this device is temporarily inoperative.

2. Electric Operation - The refrigerator can be operated on 12-volts DC or 110-volts AC provided the voltage-change switch (A) is set at the appropriate position.
 - a. Turn off the gas valve (B), its handle (G) will then be pointing away from the back of the cabinet.
 - b. Turn the voltage-change switch (A) so that the required voltage marking is next to the red indicator mark at the right-hand side, then connect the refrigerator to the appropriate voltage supply. (When the electrical supply cord is connected to a 110 volt AC supply, the voltage on the switch (A) should show 110.
 - c. Turn the electric thermostat knob (F) to No. 3. The ice-tray shelf should show signs of cooling after about an hour.

NOTE:

Keep items to be stored in your RV refrigerator or ice box in your home refrigerator or freezer until you are ready to leave. This will reduce the cooling load on your RV refrigerator or ice box and help keep perishable foods fresh longer. Always store food in sealed containers or suitable wrapping. During travel, use the door latch.

- The refrigerator requires 24 hours running time to cool down.
- If the refrigerator has been out of use for an extended period, make sure all air vents are free from obstruction and check for gas leaks using soapy water.
- Never cover or partially cover the air vents with cardboard or anything else.
- Remember to level the vehicle when stopping for more than about an hour, otherwise the cooling unit could be permanently damaged due to overheating if it is left on.

For recommended maintenance, refer to appliance instruction booklet.



WARNING

Turn on only one energy source at a time.

FURNACE

The RV furnace is an LP gas appliance. Heat is discharged into the unit directly through the furnace grill. To operate the furnace, first remove cabinet front. Turn main gas valve control knob to the OFF position (see Figure 1). Move OFF lever, located at the bottom of thermostat to the right if set on OFF position. Set the thermostat above room temperature. A slight delay will occur before the blower starts. Allow the blower to run for five minutes for combustion chamber purge cycle. After five minutes, set thermostat below room temperature. Turn main gas valve control knob to ON position (see Figure 1). Set thermostat above room temperature. Allow 30 seconds for ignition to occur after the blower comes on. If burner does not ignite, return main gas valve control knob to OFF (see Figure 1). Set thermostat on OFF.

NOTE:

If after three attempts with no ignition, go to shut-down and contact a qualified service agency. Do not continue to cycle furnace through thermostat in an attempt to get ignition.

CARE OF FURNACE

Your furnace should be inspected before use at least annually by a qualified service agency. Particular attention should be given to the combustion chamber gaskets, soot in vent and main burner. Check your furnace owners manual (supplied with furnace) for more information and before operation of furnace.

⚠ WARNING!

DO NOT use catalytic or open flame heaters in your Viking unit. This includes wood and charcoal grills and stoves. The use of this equipment inside the vehicle may cause fires. These devices, either portable or permanently installed, consume oxygen from the interior space and may contaminate the air with toxic fumes. These fumes may cause nausea, dizziness or death.

WATER HEATER (Limited Application)

The water heater is an LP gas appliance capable of heating water to a preset temperature. The water heater is a match light ignition appliance. When the system is connected to city water, fill the water heater by opening a hot water faucet. When filling the fresh water tank, turn the water pump ON and open a hot water faucet. In either case, when water flows steadily, turn the faucet OFF. Any air still in the tank can be removed by opening the relief valve in the outside access compartment.

Before attempting to ignite any of the water heater models, be certain to OPEN the LP gas bottle service valve.

LIGHTING PILOT

Turn the gas knob to OFF. Always wait five minutes to allow LP gas, which may have collected in the burner compartment, to dissipate. Your water heater will be equipped with a Robertshaw "UNITROL" thermostat or an ITT General Control Thermostat.

⚠ WARNING!

CAUTION: DO NOT light pilot unless water heater is full of water.

ROBERTSHAW "UNITROL" THERMOSTAT

Turn the gas knob counter-clockwise to PILOT. Press and hold the reset button while you apply a lighted match to the pilot burner. Release the reset button after pilot has burned one minute (repeat procedure if pilot goes out). Turn the gas knob to ON.

ITT GENERAL CONTROL THERMOSTAT

Turn and hold the gas knob to the PILOT position as you hold a lighted match to the pilot burner. Release the gas knob after one minute (repeat procedure if pilot goes out). Turn the gas knob to ON.

TEMPERATURE CONTROL

Adjust the Temperature Control lever on either Unitrol or ITT thermostat to the desired temperature as marked on the control.

The main burner will light automatically and burn as needed to maintain the temperature you have selected. It is a good idea to light the water heater the night before you leave and turn it off in the morning. The water will remain hot for some time while you are traveling.

PILOT ADJUSTMENT

Remove the pilot adjustment screw protective cap and turn set screw to adjust the flame so it is 1/2" high.

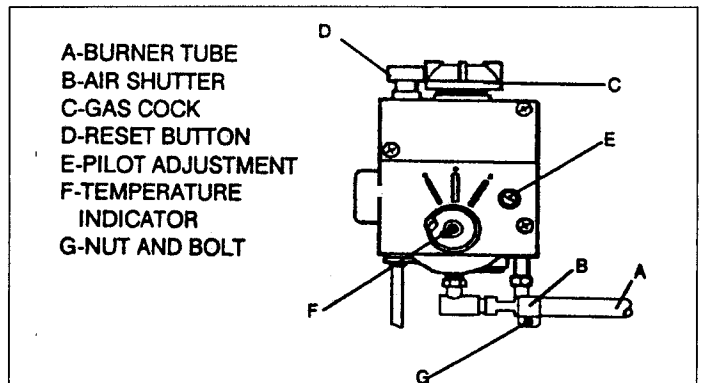

BURNER ADJUSTMENT

Loosen the set screw which holds the air shutter in place. Slide the main burner air shutter to the right until the flame has a yellow tip. Slowly slide the shutter to the left until the yellow tip disappears. Tighten set screw.

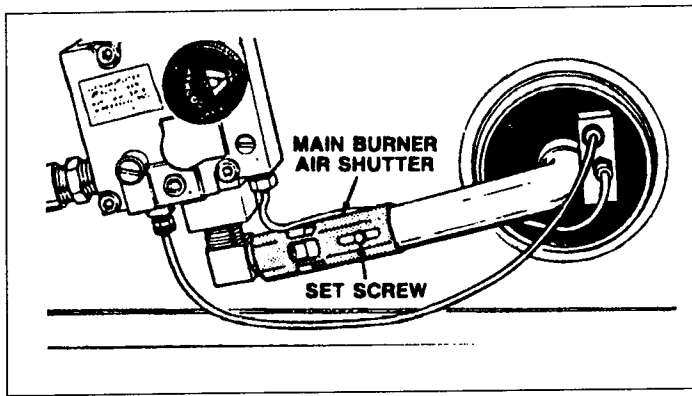

WATER HEATER BURNER ADJUSTMENT

EXTINGUISHING BURNER

Turn the gas knob to OFF.

DRAINING

The hot water system has a drain plug or drain cock in the line near the water heater which must be opened or removed to drain the water heater tank. To facilitate drainage, open all hot water faucets. When water ceases to drain, replace plug.

Because of the location of the drain plug, about two quarts of water will remain in the bottom of the tank. This can be flushed as described in **CARE OF WATER HEATER**.

⚠ WARNING!

CAUTION: Hydrogen gas can be produced in a hot water system served by a heater that has not been used for a long period of time (generally two weeks or more). **HYDROGEN GAS IS EXTREMELY FLAMMABLE.** To reduce the risk of injury under these conditions, it is recommended that the hot water faucet be opened for several minutes at the kitchen sink before using any electrical appliance. If hydrogen is present, there should be an unusual sound such as air escaping through the pipe as the water begins to flow. There should be no smoking or open flame near the faucet at the time it is open. Contact your dealer or the Service Department at the address on the manufacturer's warranty if you are not certain of what action you should take.

CARE OF WATER HEATER

Be certain the exterior compartment is clean and does not contain combustible materials. Never obstruct the relief valve or exhaust vent. Periodically drain and flush the water heater tank.

To flush the tank, a water or air hose can be connected to the water inlet or outlet (inside the unit) or to the relief valve port (in exterior compartment). To use the relief valve port, the relief valve must be removed. Use a pipe or crescent wrench to turn the valve counterclockwise. Attach

water or air hose and flush (if air is used, until water ceases to drain). Replace the water inlet or outlet hose or the relief valve and replace the plug. The water heater is now ready for refilling or storage.

NOTE:

The relief valve must be replaced securely. Use a non-toxic pipe compound to assure a water tight seal.

**LP GAS BOTTLE INSTALLATION
DOUBLE BOTTLE**

See page 48 for installation instructions.

After completing installation:

Check the gas lines by turning off all burners and pilot lights. Open all doors and windows. Open the LP gas service valves and use soapy water, a bubble solution or an approved leak detector to test all line connections. Do not use products that contain ammonia or chlorine. Bubbles indicate a leak. Tighten the connections by hand until bubbles stop.



LPG HOSE ROUTING

NOTES

LP GAS BOTTLE INSTALLATION SINGLE BOTTLE

1. Remove the LP gas bottle, bottle bracket, two (2) lock nuts and two (2) 1/4" bolts from the inside of the unit. Fill the LP gas bottle. Make sure that the service valve on the LP gas bottle is closed while making the following connections.

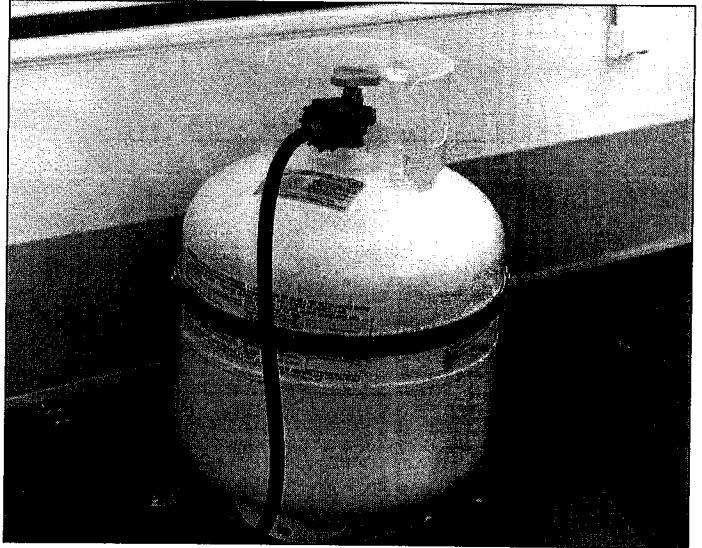

2. Extend the legs on the bottle bracket and loosen the tightening screw. Set the bracket on the bottle rack in the A-frame. The legs of the bracket should extend diagonally across the bottle rack. Use the two (2) bolts and lock nuts to securely fasten the bracket to the unit.
3. Slip the LP gas bottle through the ring of the bottle bracket. Tighten nut until the bracket is tight around the bottle. Then tighten nuts connecting bottles to the A-frame.
4. Connect the LP gas hose.
5. Check the gas lines by turning off all burners and pilot lights. Open all doors and windows. Open the LP gas service valve and use soapy water, a bubble solution or an approved leak detector to test all line connections. Do not use products that contain ammonia or chlorine. Bubbles indicate a leak. Tighten the connections with two (2) open end wrenches until bubbles stop.



WARNING!

MAINTENANCE

GENERAL

Recreational vehicle owners are noted for the pride they take in the appearance of their units. Proper maintenance will do more than keep your Viking unit looking nice. It can help insure trouble-free operation and maximum efficiency of the various appliances and components. Failure to properly maintain the vehicle or its components also may constitute a breach in your warranty obligations. Negligence, misuse or installation of unauthorized equipment could affect the operation of your unit and may void your warranty. See the various manufacturer's manuals for specific maintenance instructions.

After each trip, set up your camper in your driveway and clean thoroughly. Discard all unused food items, especially those items stored in the ice box or refrigerator to avoid attracting insects or animals.

CONDENSATION

Condensation can be a natural occurrence in modern, tightly constructed, recreational vehicles. When the unit is tightly closed, especially in cold weather, the relatively small air volume in the RV can absorb only a certain amount of moisture. When the saturation point is reached, the moisture is released in the form of condensation. (Certain amounts of condensation should be expected, especially on cool surfaces such as windows and metal door frames.) However, excess condensation can damage walls and ceilings. Bathing, dish washing, appliances and unvented gas burners, all add moisture to the air. You can control this by allowing the moisture to escape to the outside. Use your roof vent when cooking; don't hang wet clothes in your unit to dry. Opening a window slightly and the use of fans to circulate air will reduce condensation.

TENT

To condition the tent prior to your first trip, set up the camper and spray with water. Allow the tent to dry and then spray again. This will expand the thread inside the stitch holes. Always ventilate and dry the tent with bows and braces in place, as soon as possible after each exposure to moisture. After every trip, wash dust and dirt, bird and tree droppings, insects and other foreign material from the exterior tent surfaces. These substances can damage the vinyl in your tent. Use warm water and a soft bristle brush to remove stubborn stains. Rinse tent with cool water. Allow the tent to dry completely before lowering. Mend tears and holes with patching material or cement. Leaks in tent seams can be repaired by using a good commercial seam sealer.

CAUTION: Use of sprays (hair, insect, deodorant, etc.) near fabric can destroy fabric finish. NEVER allow spray to come in contact with tent fabric.

INTERIOR MAINTENANCE

FOLDING DINETTE SEATS

Fold table legs and secure with straps. Lower table onto seat braces. Arrange cushions on top for additional sleeping capacity.

VINYL WINDOW & SCREENS

Unzip vinyl windows to permit ventilation. Roll vinyl and secure in place with straps.

CARE OF PRIVACY CURTAINS AND DRAPES

Curtains are to be dry cleaned only. Curtains and drapes slide along tracks.

CARE OF WOODWORK

Clean woodwork with regular household furniture polish. DO NOT use water to clean wooden surfaces. Scuffs may be covered with furniture wax and stain mixture. Scratches may be covered with putty stick.

CARE OF DRAWERS

Clean wooden surfaces with household furniture polish. Wash plastic surfaces with warm water and liquid soap. DO NOT use abrasive cleansers.

CARE OF FLOORING

Sweep and damp mop vinyl floors.

AIR QUALITY

State-of-the-art construction and energy conserving methods have made indoor air quality a matter of increasing concern. Air infiltration and air exchange rates have been substantially reduced. Thus, certain air-borne contaminants, which were previously dissipated by normal air infiltration and air exchange, tend to accumulate in your recreational vehicle. These contaminants may be generated by building products emissions, smoking, cooking, fuel burning appliances and usual human activity. Adequate ventilation will reduce the level of air contaminants. Such periodic airing is required on a regular basis particularly during periods of high temperature and high humidity and after prolonged storage.

ROOF

Frequently check the seals around all extrusions, handles, lights, roof center seam, etc. **Reseal as necessary with a silicone sealer.** With expansion and contraction from weather and use, these seals need to be maintained or damage to your roof from water will result.

BODY

Wash dust and dirt, road tar, bird and tree droppings, insects and other foreign material from exterior surfaces. Use a mild soap in cold or lukewarm water. Apply a good quality auto wax at least once a year.

WARNING!

CAUTION: To avoid marring body surfaces, DO NOT use abrasive cleaning compound or cloth. DO NOT wipe the surface with a dry cloth; DO NOT wash or wax your unit in the hot sun, wait until the surfaces have cooled.

FRAME

Inspect the frame periodically. Remove dirt and rust and apply rust preventative paint as required routine maintenance.

ELECTRIC BRAKES

After a break-in period of 200 miles, brakes should be adjusted. Inspect and adjust brake drums, lining and shoes at the beginning of each camping season or before an extended trip.

WHEEL BEARINGS

Check wheel bearing lubrication at the beginning of each camping season or before an extended trip. Follow directions for E-Z lube in Dexter Axle manual provided with your warranty packet.

LIFT SYSTEM

Periodically, the telescoping arms of the crank lift system should be lubricated with silicone spray.

WARNING!

CAUTION: Do not get lubrication on tent material.

STORAGE

GENERAL

You should perform the following procedures if you will not be using your unit for an extended period.

LP GAS SYSTEM

Close the LP gas service valve. Extinguish all pilots and close all LP gas valves. Light a range burner to consume any gas remaining in the lines. When the flame burns out, turn the range burner OFF.

WATER TANK

Open the water tank drain cock and empty tank. Close the drain cock when the tank is empty. If unit is equipped with a water heater and pump, it will require a more detailed service, see dealer.

ELECTRICAL SYSTEM

Turn off the circuit breaker at the service box.

EXTERIOR

Store your unit in a garage or other shelter, if possible, or cover with tarpaulin or plastic. Do not allow snow to collect on the roof. If you will not be using your trailer for an extended period, block it up to prevent tire damage.

NOTE:

Do not cover with black or dark colored plastic or seal airtight.

WINTERIZATION

(Also see Maintenance Schedule pages 31 to 34.)

GENERAL

You should make special preparations for storing your unit in winter. All systems, components and appliances should be inspected and repaired prior to storage. Winterize the unit before removing the batteries.

Drain the fresh water system as described in STORAGE section, then pour two gallons of approved, non-toxic RV antifreeze into the gravity water fill. This will allow you to winterize the fresh water and drainage systems. Follow the checklist on following page:

▲ WARNING!

CAUTION: DO NOT use automotive antifreeze in the fresh water system; it is poisonous.

FRESH WATER SYSTEM

Can be winterized by briefly opening the faucet and pumping water in with the sink drain closed. Close faucet and stop pumping when antifreeze pours out.

DRAINAGE SYSTEM

Should be winterized by removing the sink drain plug to allow antifreeze to circulate through the line. Pour an additional two cups of RV antifreeze into each drain.

LP GAS

System should be prepared as described in the STORAGE section. The regulator also should be covered to keep moisture out of the vent. LP gas bottles should have anhydrous methanol added by an LP gas supplier.

DRAPES

Should be removed.

COUNTER TOPS AND CABINETS

Should be cleaned.

REFRIGERATOR / ICE BOX

Should be cleaned and the door propped open. Cover exterior panels.

FURNACE

Should be cleaned and exterior vents covered.

RANGE

Should be cleaned.

BODY

Should be cleaned and waxed. Locks and hinges oiled and snow accumulation should be removed with a long-handled broom.

UNIT

Should be placed on wooden blocks or jack stands on a firm, level surface. Tires should be removed, partly deflated, hung on a wall, and covered to protect them from sunlight.

FIRE SAFETY

Prevention is the best form of fire safety. Follow the instructions previously listed for care, maintenance and operation of the various appliances in your vehicle. Make certain everyone in your party is familiar with emergency features of the unit, the locations of exits and the location and operation of fire extinguishers. A chemical fire extinguisher has been furnished with your unit. Follow the same rules of prevention that you would at home. DO NOT smoke in bed. DO NOT overload the electrical wiring. DO NOT use matches, candles or lighters to look into dark closets or drawers. DO NOT leave FOOD cooking unattended. DO NOT permit children to play with the controls of LP gas or electrical appliances. DO NOT store flammable liquids inside your unit. If a fire does start, get all members of your party outside. Close the LP gas service valve. If it is a small fire, use the fire extinguisher. If the fire cannot be extinguished quickly, GET OUT! Disconnect the Shoreline power cord from the campground receptacle and move a safe distance away from the unit. Call the fire department. DO NOT re-enter the vehicle until officials declare it safe to do so.

VISITING CANADA OR MEXICO

GENERAL

Passports or visas are not required for entry into CANADA or MEXICO. However, tourists cards are necessary for Mexico! If you will be staying more than 72 hours or travel farther than 40 miles from the border. Cards can be obtained at the port of entry or from a Mexican consulate. You should carry your birth certificate, voter's registration card, baptismal certificate or similar proof of identity when entering another country. Naturalized U.S. citizens should carry their naturalization papers or other proof of citizenship. Persons under 18 years of age should carry a notarized letter from their parents or guardians giving them permission to travel in CANADA or MEXICO.

The information in this section is general in nature and subject to change by the Canadian or Mexican government. For specific information, including rules for re-entering the U.S., as well as points of interest and campsites, contact the consulate nearest the point at which you plan to enter the country.

VEHICLES

No special driver's license or permit is necessary in either country, but renew your license if it has or will expire during the trip. Proof of vehicle ownership is required at the border. If you are using someone else's unit, you should have a notarized letter authorizing its use. MEXICO requires a vehicle permit for every self-propelled vehicle. The permit can only be obtained from Mexican customs (Aduana) offices upon presentation of tourist card, vehicle registration and title or notarized statement from owner.

CANADA requires a Canadian Non-Residential Inter-Provincial Motor Vehicle Liability Insurance card, which is only available from U.S. agents. All Provinces in CANADA require evidence of financial responsibility if visitors are involved in an accident. Limits vary from Province to Province. Contact your insurance agent for details. Your insurance policy is NOT valid in Mexico. Temporary insurance must be purchased from Mexican companies whose offices are located near the border.

CB RADIO

CB radio operation in CANADA requires a temporary license which can be obtained by writing Regional Director of Telecommunications, Regulation Branch, Department of Communications, 20th Floor, 2085 Union Avenue, Montreal, Quebec H3A 2C3, Canada. Mexico currently prohibits the use of CB radios.

HUNTING AND FISHING

Each Province has its own laws and license requirements. You must provide a written description and serial number of each gun at the border. Revolvers, pistols and fully automatic firearms are prohibited in CANADA. A license must be obtained from the Province in which you intend to hunt or fish. Further information can be obtained by writing the Department of Lands and Forests, Wildlife Branch, in the Province you intend to visit. Hunting and fishing laws in MEXICO are extremely complicated. Request information from Secretaria de Comunicaciones, Estados Unidos Mexicanos, Mexico DF.

DOGS AND CATS

CANADA requires a certificate, signed by a licensed veterinarian in the U.S. or CANADA, attesting that a dog has been vaccinated for rabies in the past 12 months. The certificate must contain a description of the dog and date of vaccination. Puppies under three months old need no certificates.

There is no restriction on the entry of healthy cats. A certificate, signed by a licensed veterinarian, describing the pet and attesting that it has had a rabies shot in the past six months, is required in MEXICO. A fee is charged for the required verification of the certificate by a Mexican consulate.

TOURIST INFORMATION

Obtain current road maps and tourist information from each state through which you intend to travel. You also may want to purchase a tourist guide book.

If you will be visiting federally operated national parks, monuments and recreation facilities, you may wish to look into the Golden Age Passport and the Golden Eagle Passport. They can help families cut spending at those areas where fees are involved.

GOLDEN AGE PASSPORT

The Golden Age Passport is a free lifetime pass for persons 62 and over and covers all admission fees and a 50% discount on use fees (except fees charged by private concessionaires). It may be obtained only at park service offices and at parks where entrance fees are charged. It cannot be obtained by mail or at post offices. To obtain a Golden Age Passport you will need proof of age, such as a driver's license, or be prepared to sign an affidavit swearing that you are 62 or over.

NOTE:

Medicare cards are not accepted since in some cases they are issued to younger persons.

GOLDEN EAGLE PASSPORT

The Golden Eagle Passport costs \$10 and is designed for persons who plan to visit several parks or federally operated facilities in a single year. It covers all admission charges, but does not cover use fees and is good only during the calendar year in which it is issued. It may be purchased in person or by mail at the National Park Service Headquarters, Department of the Interior, Washington, D.C., 20240; at regional offices and at facilities where entrance fees are charged.

Both the Golden Age and Golden Eagle Passports cover admission fees for the permit holder and any persons accompanying him or her in a private vehicle. Where entry is not by vehicle, the passport covers the permit holder and members of his or her immediate family.

ELECTRICAL SPECIFICATIONS

LIGHT BULBS

Interior 12 VDC	#1003 or #1141
Turn, Tail and Stop.....	#1157 or #2057
License Plate	#168
Clearance.....	#194

FUSE / CIRCUIT BREAKER SIZES

12 VDC Appliances	15 Amp Fuse
120 VAC Circuits.....	15 / 20 Amp Breaker

WATER PUMP FUSE 15 Amp Slo Blo

WIRE HARNESS COLOR CODES

White.....	Ground
Brown.....	Right Stop and Turn
Red	Left Stop and Turn
Blue.....	Brakes
Pink	Converter
Green.....	Clearance

ADDITIONAL OR OPTIONAL EQUIPMENT WEIGHING OVER 20 LBS. WHEN INSTALLED

7,100 BTU Roof Air Conditioner	82 lbs.
20,000 BTU Furnace.....	23 lbs.
Water Heater	69 lbs.
2nd LP Gas Bottle with Gas.....	38 lbs.
Three Burner Range	18 lbs.
35 lb. Ice Box with Ice.....	47 lbs.
2.5 Cu. Ft. Refrigerator	40 lbs.
Awning Wts. 7/8/9/10/11.....	18/22/24/25/29 lbs.
11M Air Conditioner	95 lbs.
13.5M Air Conditioner.....	104 lbs.
Screen Rooms 7/8/9/10/11.....	10/37/38/39/40 lbs.



WARNING!

All assembled roof accessories should not exceed 120 lbs. during operation of lift system.

TROUBLE SHOOTING

NOTE:

Use the manufacturer's owner's manuals for all appliance trouble shooting.

FURNACE DOES NOT LIGHT

Check the LP gas supply

If the furnace does not light after several attempts, do the following:

1. Turn the thermostat and furnace gas control valve OFF.
2. Contact your RV dealer or service center. DO NOT attempt to repair or adjust the furnace yourself.

WATER PUMP FAILURE OR MALFUNCTION (Electric pump equipped models only)

If the pump fails to start when the switch is ON, check the fuse located in the converter. If the pump continues to operate whether the faucets are opened or closed, check the water tank. It might be empty or there might be a leak in the system. If water pump goes on and off, check all fittings for tightness and all lines for leaks.

GALLEY PUMP NOT OPERATING CORRECTLY

1. Be sure cap is tightly secured on city water inlet.
2. If pump still does not operate correctly, place finger over spout outlet and pump plunger up and down to prime water system.

NO POWER TO UNIT

Check Shoreline. Make sure you have power to the Shoreline.

Check the converter; the breaker switch(es) might be off or tripped.

CONVERTER MAKES CLICKING NOISE

Check circuit for overload.

Check for reversed AC polarity.

UNIT HAS ELECTRICALLY CHARGED (HOT) CHASSIS

Disconnect unit from electrical supply.

Have unit inspected and repaired, if necessary, by a qualified service facility.

NOTE:

Determine if Shoreline supply has proper polarity.

REFRIGERATOR WILL NOT COOL

Make sure unit is level. Check that lower and upper refrigerator vents are clear. If on gas, check gas supply. Run 24 hours in advance of trip departure.

LIGHTS DIM OR HALF BRIGHT

Possible converter malfunction. Possible low voltage from Shoreline.

SMELL GAS

1. Extinguish any open flames, pilot lights and all smoking materials.
2. Do not touch electrical switches.
3. Shut off the gas supply at the tank valve(s) or gas supply connection.
4. Open doors and other ventilating openings.
5. Leave the area until odor clears.
6. Have the gas system checked and leakage source corrected before using again.

LIGHTS FLICKERING

Check to see if the following could be causing the problem; loose fuse holders, broken fuse, broken connection or wire, bad ground.

MAINTENANCE

COMPONENT	IDENTIFICATION	STANDARD CARE	FREQUENCY	AVOID
Awning	Self-storing	Household vinyl cleaner	As needed	Storing wet for extended periods
Axle	Spring Torflex	Maintenance free Maintenance free		Road hazards and overloading
Bearings	Tapered roller	Lubrication-Refer to Dexter Axle book provided in warranty packet.	Every 2,000 mi. and before each season	Road hazards, overloading, over / under tightening
Bed Slides	Aluminum / steel	Use silicone lubricant sparingly	As needed	Unsupported beds, over-lubrication
Beds	Plywood Laminated	Use all support poles	Always	Not using proper support
Brakes	Dexter 7" 10" Certain Models	Linings and adjustment See brake manual	Before each season and as needed	Over-adjustment, under-adjustment
Ceiling lights	1.5 amps	Replace bulb - use only the style provided as original equipment	As needed	Lights on when unit is closed and connected to tow vehicle
City water fill	Ft. Recovery	Cover when not in use	Always	Over-tightening, under-tightening
Converter	12-25 amp	Use proper size fuses as noted on converter		Over-loading, attempting repairs
Coupler	Atwood	Lightly grease ball and oil release lever rivet.	Once per year	Improper connection to ball
Decorator side drapes and privacy curtains	Woven antique satin	Dry clean only	As needed	Machine washing and storing wet
Drain (sink)		Winterize with non-toxic anti-freeze	When storing for winter	Storing without winterizing
Drain (shower)		Winterize with non-toxic anti-freeze	When storing for winter	Storing without winterizing
Entrance door	Aluminum	Wash with water and apply quality auto wax, lubricate channels and latches with silicone	As needed	Abrasive cleaners
Exterior body panels	Filon Aluminum ABS	Wash with mild detergent and water and apply quality auto wax	As needed	High pressure spray on graphic labeling areas
Fire extinguisher	Red, recessed into cabinet near door or on a bracket	Check for charge prior to each camping trip; note directions on extinguisher		
Floor covering	Seamless vinyl, no-wax	Clean with mild soap and water as needed	As needed	Abrasive cleaners
Frame	E-Kote	Rinse with water as needed after salt or chemical contact; sand and touch-up bare or rusty spots with good quality black paint	As needed	Chemicals or road salt, road hazards
Furnace	20,000 BTU	See furnace manual		
Gas bottle	On A-frame	See "Gas System" - Be certain that clamp is secure	Every trip	Loose clamp
Gas hose	Rubber	See "Gas System"		
Gas line	Copper	See "Gas System"		

MAINTENANCE

COMPONENT	IDENTIFICATION	STANDARD CARE	FREQUENCY	AVOID
Inside / Outside range	L.P. gas	Warm soapy water for cleaning; towel dry. DO NOT leave outside in rain.	Clean as needed	Leaving unattended; applying excessive weight to shelf; getting unit wet
Lift posts	Zinc plated steel	Lubricate with silicone	Once per season as needed	Over-lubrication
Lug bolts	13/16"	89-95 foot-pounds	Before each trip	
Pigtail	6 wire	Always use cable provided; inspect for cuts, breaks or dirt; plug in securely	Prior to each use	Cutting; dirt, corrosion
Pre-finished cabinet walls		Spray furniture wax	As needed	Leaving outside in rain; abrasive cleaners, detergents and water
Pump (electric)	Flo-Jet	Winterize with non-toxic anti-freeze	When storing for winter	Storing without winterizing
Pump (hand)	JC Water System	Lubricate stem with mineral oil	Once a year	Storing without winterizing
Refrigerator Ice Box	Dometic Wrico	Clean with mild soap and water Block door open while stored	As needed	Leaving food inside while unit is being stored; abrasive cleaners
Roof assembly Exterior	Aluminum/Filon sandwich panel ABS	Wash as needed; inspect for voids in caulking	Check caulking once per season as needed	Abrasive cleaner; excessive weight (135 lb. max. on opt. boat rack) abrasives and sharp instruments
Interior	Vinyl and plywood	Clean with water and mild soap solution	As needed	
Shower pan	A.B.S. plastic	Sponge clean after use	As needed	Abrasive cleaners
Crank Down Jack	B.A.L	Keep free of dirt; lubricate	As needed	Dirt build-up
Table	Particle board laminated	Clean with damp cloth	As needed	Direct heat; excessive exposure to elements
Table legs	Folding	Lubricate hinge points with silicone	As needed	Leaving outside in rain; abrasive cleaners, detergents and water
Tent, vinyl	Vinyl	See page 24 of this manual	As needed	Storing wet, harsh detergents, detergent residue, all chemicals
Tires	Americana Tire	See specifications and check inflation	Every trip or as needed	Under or over inflation Avoid road or off-road hazards
Tongue jack	AL-KO	Lubricate mechanism with light oil, retract or remove jack and wheel for travel	Once a year	Salt and chemical contact, travel with wheel down
Upholstery (cushions and mattresses)	Olefin or olefin / acrylic	Car upholstery cleaner	As needed	Grease, oil, excessive heat, sharp objects
Vinyl windows	Tinted clear vinyl	Warm water and mild detergents	As needed	Abrasives, aromatics
Water heater	Suburban	See page 21 of this manual		Storing without winterizing
Water tank	Polyethylene	See "Water System" Sanitize and flush. See page 17	As needed	Contaminants
Winch (crank-lift models)		See "Lift system" page 10		Failure to Lubricate

MAINTENANCE SCHEDULE

QUICK REFERENCE

ITEM							REFERENCE
	Every Trip	Every 30 days or 1,000 miles	Every 60 days	Every 90 days or 2,500 miles	Every 6 months or 5,000 miles	Annually or 10,000 miles	
Airing	X						Air Quality, Condensation, Maintenance, this manual
Appliances	X					X	Appliances, this manual; Appliance Manufacturers' instructions
Body						X	Maintenance, this manual
Counter, Table Tops	X						Maintenance, this manual
Doors				X			Maintenance, this manual
Electrical System	X						Maintenance, this manual
Fabrics						X	Care of Fabrics, this manual
Floor Coverings	X						Maintenance, this manual
Hinges						X	Maintenance, this manual
Jacks	X			X			Maintenance, this manual
Locks & Latches						X	Maintenance, this manual; Lock/Latch Manufacturer's manual
LP Gas	X	X					LP Gas, this manual; Appliance Manufacturer's Instructions
Pigtail Contacts				X			Maintenance, this manual
Roof, Body, Underbelly				X			Maintenance, this manual
Seams (Seal), Roof					X		Maintenance, this manual
Steps	X					X	Maintenance, this manual; Step Manufacturer's instructions
Vents						X	Maintenance, this manual; Vent Manufacturer's Instructions
Vinyl Ceiling and Wall Panels	X						Maintenance, this manual
Water Heater	X					X	Maintenance, this manual (Water Heater Manufacturer's instructions)
Wood Cabinetry	X	X					Maintenance, this manual

Maintenance schedules listed are minimum requirements; heavy use, unusual temperatures or humidity, or other environmental conditions may require more frequent maintenance.

MAINTENANCE RECORD

DATE	MILEAGE	SERVICE SHOP NAME & ADDRESS	DESCRIPTION OF SERVICE

APPLIANCE IDENTIFICATION FORM

Should your unit or one of the appliances require warranty service, you will have to identify the manufacturer, model designator and serial number. Fill in this form as soon as possible. It will help you meet our identification requirements. Depending on your unit, certain items listed below may not be offered as either optional and / or standard. Most of this information can be found on the Recreational Vehicle Data Card attached to the inside of one of the kitchen cabinet doors.

EQUIPMENT	MANUFACTURER	MODEL DESIGNATOR	SERIAL NUMBER
Camper	Viking		
Furnace			
Range			
Converter			
Refrigerator			
Water Pump			
Water Heater			
Air Conditioner			
Door Key			
Exterior Storage Compartment Keys			

“GP” UNITS EQUIPPED WITH E-Z POWER LIFT SYSTEM

GENERAL INFORMATION

SYSTEM DESCRIPTION

The hydraulic lift system consists of a miniature hydraulic pump directly connected to a fractional horsepower 12V electric motor. This combination powers a hydraulic cylinder that lifts the roof. The system is extremely powerful, and can do severe damage to the trailer or anything that obstructs the lifting action. **!!!CAUTION!!!** Do not allow the motor to continue operating after the roof has reached the raised position, as it will damage the pump or motor. At the end of the cylinder stroke you will notice an immediate reduction in the pump rotation sound

The hydraulic cylinder is attached directly to the cable mechanism. Due to the design of the lift mechanism, the roof will have a slight jerking motion as it is being raised or lowered. To keep this action to a minimum, refer to your camper Owner's Manual concerning the type of grease and

how often to apply it to the under body tube assembly and 4 corner telescope lift tubes.

Lowering of the roof requires only the opening of the hydraulic valve, which will allow the roof to lower to a closed position. Note that the roof can be stopped at any point when lowering by closing the valve, or use it to control the lowering speed.

!!! CAUTION !!!

READ THE ENTIRE OWNER'S MANUAL BEFORE USING OR INSTALLING THIS EQUIPMENT, THE MANUAL CONTAINS SAFETY PRECAUTIONS, INSTALLATION TIPS, PARTS LIST, AND OPERATION INSTRUCTIONS. KEEP THIS MANUAL IN A SAFE PLACE FOR FUTURE REFERENCE. SUBJECTS CONCERNING SAFETY OR CRITICAL OPERATING POINTS HAVE BEEN IDENTIFIED WITH THE **!!!CAUTION!!!** NOTATION.

TRAVEL PREPARATIONS BEFORE YOU START

HOME SECURITY

Make arrangements for someone to check your house periodically. Stop mail and newspaper delivery. If you intend to be away for more than two weeks, request police surveillance. Carry an extra set of vehicle and house keys on a separate key ring.

GENERAL

Determine the various items of equipment, clothing, food and other supplies required for the length and destination of your journey. In a subsequent section, the importance of proper loading is explained, but at this stage you're more concerned with a quick getaway. One way to reduce loading time is to purchase dinnerware, flatware, pots and pans and towels which can remain in your unit at all times. After a trip, clean and launder the articles and replace them in your RV, ready for your next trip. You may want to photocopy the handy check list on page 38 to help your travel preparation.

IMPORTANT DOCUMENTS

Carry your vehicle registration and insurance policy card(s). If you are borrowing a vehicle, you should have a notarized letter of authorization from the owner with you.

SAFETY

Flares and reflectors; flashlights; first aid kit; tow rope and / or nylon tow strap and jumper cables.

EQUIPMENT

Fresh water hose (non-toxic, garden type) and bucket; "Y" type water hose fitting; 20-foot, three-prong power cord; three-prong adapter with grounding wire; fuses; wheel chocks; leveling ramp or blocks; tent repair kit.

TOOL CHEST

Include an assortment of wrenches and screwdrivers, pliers, hammer, tire pressure gauge, small level, electrical and masking tape.

ADDITIONAL TOOLS

Hatchet, saw, shovel and 12-volt portable tire pump.

CLOTHING

Compile a clothing list for each person. Consider the season and areas through which you intend to travel.

SLEEPING GEAR

Sleeping bags are ideal for cold climates, but sheets and blankets are better suited for warm weather. Take along an extra blanket or two for sudden drops in temperatures, such as can be expected in mountain areas even during summer.

CAMP HYGIENE

Dish soap, dishcloths and dish towels, garbage and trash bags.

PERSONAL HYGIENE

Toilet paper, soap, washcloths, towels, toothbrush, toothpaste, deodorant and shaving kit.

FOOD AND WATER

Don't try to take a food supply for an extended trip. Take enough for two or three days and replenish supplies along the way. Take a basic supply of seasonings; sugar, salt, pepper and spices. Plan meals so that fresh or refrigerated items are used before they spoil. Fill your fresh water holding tank before leaving.

MEAL PREPARATION

Bottle cap and can opener; matches, lighter or igniter device; pots, pans, plates, glasses and cups (paper or plastic are lighter and less likely to break while the vehicle is in motion); silverware and carving knife.

ENTERTAINMENT

Take along games, toys, books, magazines or other items of entertainment to occupy passengers while traveling or in case you encounter inclement weather.

PRE-TRAVEL CHECK

GENERAL

Whether departing from your home, rest area, or campsite, you should perform these pre-travel checks inside and outside your camper.

VINYL TENT

Be sure tent is dry before storing camper. While camping, a leaky seam may be sealed by rubbing candle wax or bee's wax into stitch holes.

TIRES

Should be inspected before each trip. Replace a tire when it is worn to 1/16" depth in two or more adjacent grooves, or to the level of tread indicators molded into the bottom of the tread grooves, when the indicators appear in two or more adjacent grooves at three locations around the tire. Check tire for uneven wear, road damage, foreign objects or excessive peeling or bulging. When purchasing a new tire, be certain it is the same size and has the same ply rating and load range as the old tire. DO NOT mix radial ply with bias or bias-belted tires.

Each morning inspect tire condition and pressure on your RV and tow vehicle. Heat generated by surface friction will increase the tire's air pressure approximately six to nine psi; therefore, do not bleed air out of a hot tire. Inflate to recommended pressure as indicated on tire or in tire manufacturer's instruction booklet.

NOTE:

Proper tire inflation is extremely important.

WHEEL LUGS

Must be tightened before departure, then every 50 miles for the first 200 miles during your initial trip, and after each tire change. Torque to 85-95 pounds. Thereafter, tighten lugs periodically and before using unit after a storage period.

WHEEL BEARINGS

See **MAINTENANCE** section.

HITCH

Should be inspected to be sure it has not loosened. Must have safety pin or lock in coupler.

3-WAY TONGUE JACK

Must be raised as far as possible or removed and stored.

LP GAS BOTTLES

Connections should be secured and the service valve closed.

NOTE:

Some states prohibit vehicles equipped with LP gas bottles from using tunnels. A few other states prohibit traveling with the service valve open. Check the regulations of the states through which you intend to travel.

SAFETY CHAINS

Must be properly attached to the tow vehicle.

STABILIZING JACKS

Should be properly stored under frame. Crank up and tighten securely.

PIGTAIL

Should be properly connected to the tow vehicle's electrical harness.

LIGHTS

Should be tested on the Viking RV unit and the tow vehicle, including brake lights, turn signals, warning flashers, clearance lights, taillights and tow vehicle headlights. **MAKE SURE CONVERTER SWITCH IS IN PROPER POSITION. ENSURE INTERIOR LIGHTS ARE TURNED OFF BEFORE LOWERING THE ROOF TO PREVENT DAMAGE TO THE CANVAS DURING TRANSIT! CHECK STORAGE COMPARTMENT LIGHT**

AND TURN OFF, AS BATTERY PACK OR TOW VEHICLE WILL ENERGIZE.

REARVIEW MIRRORS

Should be adjusted so the driver can see both sides of the unit.

POWER CORD

120-volt Shoreline must be unplugged from the external source, pushed into its compartment and the cord hatch secured.

WATER FILL

Hoses must be disconnected and the caps secured.

DRAIN OUTLET

Hose must be disconnected and the cap secured.

VENTS

Should be closed and secured.

INTERIOR DOORS AND DRAWERS

Should be closed and secured. Loose items should be lashed down or stored away.

UPPER DOOR

Must be disengaged from the lower door and secured by the ceiling turn buttons.

REFRIGERATOR OR ICE BOX DOOR

Should be secured with the travel latch.

GALLEY CABINET

Must be lowered securely to avoid interference with the bunk tray.

BUNK TRAYS

Must be pushed in. Store bunk support rods and bunk bows.

EXTERIOR ACCESS DOORS AND HATCHES

For storage and equipment should be closed and locked.

STEP

Optional self-storing step in stored position.

ROOF

Must be lowered and all latches secured.

BOAT RACK

If your unit has a boat rack, the weight of the boat is not to exceed 135 lbs. Place the boat, with the bow facing forward, upside down on the boat rack and lash down securely so boat will not shift, causing damage to the rack. **DO NOT** attempt to raise the roof with the boat on the rack.

DOOR

Should be locked.

CODE OF ETHICS

1. I recognize that everyone will judge all Recreational Vehicle owners by my actions.

When camping, I will . . .

2. Dispose of sewage in recommended places only, such as approved sanitary dumping stations, and not throw plastic bags into toilets or garbage pits.
3. Discharge my kitchen sink (and shower) waste water only in designated and approved places, and watch my drain pail to see that it does not overflow.
4. Not pollute streams, lakes and other water supplies.
5. Use extreme caution with fire, leave no campfire unattended, and put out my campfire before leaving it.
6. Always thoroughly extinguish matches, cigarettes, cigars or pipe heels before discarding, not smoke when walking or riding through forests or parks, unless regulations specifically allow otherwise.
7. In campgrounds, I will place all garbage and other refuse in the receptacles provided, leaving no bottles or broken glass.
8. Not damage trees, shrubs, or other natural beauty.
9. Leave my campsite as clean or cleaner than I found it.
10. Spot my trailer so that I do not interfere with others.
11. Keep fire away from my LP gas bottles.
12. Ask permission to park on private property when no other facilities are available.
13. Comply with all rules of forests and parks where I am staying.
14. Be considerate in walking and leashing my dog.

15. Encourage my neighbors in parks to follow this Code of Ethics.

On the highway, I will . . .

16. Pull off two-lane highways periodically, if I see a string of cars behind me.
17. Not be a litterbug.
18. Use my ashtray and not toss flammable material from car windows.
19. Drive in right lane except when passing, and allow extra room for passing.
20. Comply with all Recreational Vehicle traffic regulations.
21. Watch my speed.
22. Make every effort to prevent swaying by proper driving, suitable weight distribution in the camper and automobile.

About my Recreational Vehicle and car, I will . . .

23. Be sure my car has adequate power to pull my camper.
24. Check car and trailer brakes frequently.
25. Properly secure my LP gas bottles.
26. Use suitable rearview mirrors for safety and compliance with the law.
27. Check lights, directional signals and wheel lugs daily.
28. Grease wheel bearings of trailer periodically.
29. Carry sufficient insurance to protect others in case of accident.
30. Attach my safety chains in the recommended manner.

LIMITED WARRANTY

LIMITED PRODUCTS WARRANTY

MTI INDUSTRIES, INC. warrants to the original purchaser that this detector will be free from defects of material or workmanship for a period of one (1) year. If proven to have been defective in original materials or workmanship and returned, delivery costs prepaid, MTI INDUSTRIES, INC. will repair or replace this product free of charge.

LIMITS OF WARRANTY

Repair or replacement is your exclusive remedy under this limited warranty or any other warranty (including any implied warranty of merchantability for a particular purpose). Any and all implied warranties or merchantability or fitness for a particular purpose shall be limited to the warranty period from the original date of purchase. MTI INDUSTRIES, INC., its dealers and distributors shall in no case be responsible or in any way liable for any incidental or consequential damages for any reason. Some states do not allow the limitation or exclusion of incidental or consequential damages, or allow limitations on how long an implied warranty lasts, so the above limitations may not apply to you. This warranty gives you specific rights, and you may also have other rights which may vary from state to state.

WARRANTY RETURN POLICY

No product will be accepted for repair or replacement without an authorization number (RA). RA numbers may only be issued by MTI or authorized distributors. To return products under warranty: Pack the detector carefully in a padded container. Include the RA number, an explanation of the problem, the original dated sales receipt, and your return address. Send, shipping prepaid, to:

MTI INDUSTRIES, INC.

951 Old Rand Road #104

Wauconda, IL 60084

Customer Service No. 800-383-0269

© MTI INDUSTRIES, INC.

GAS BOTTLE/BATTERY

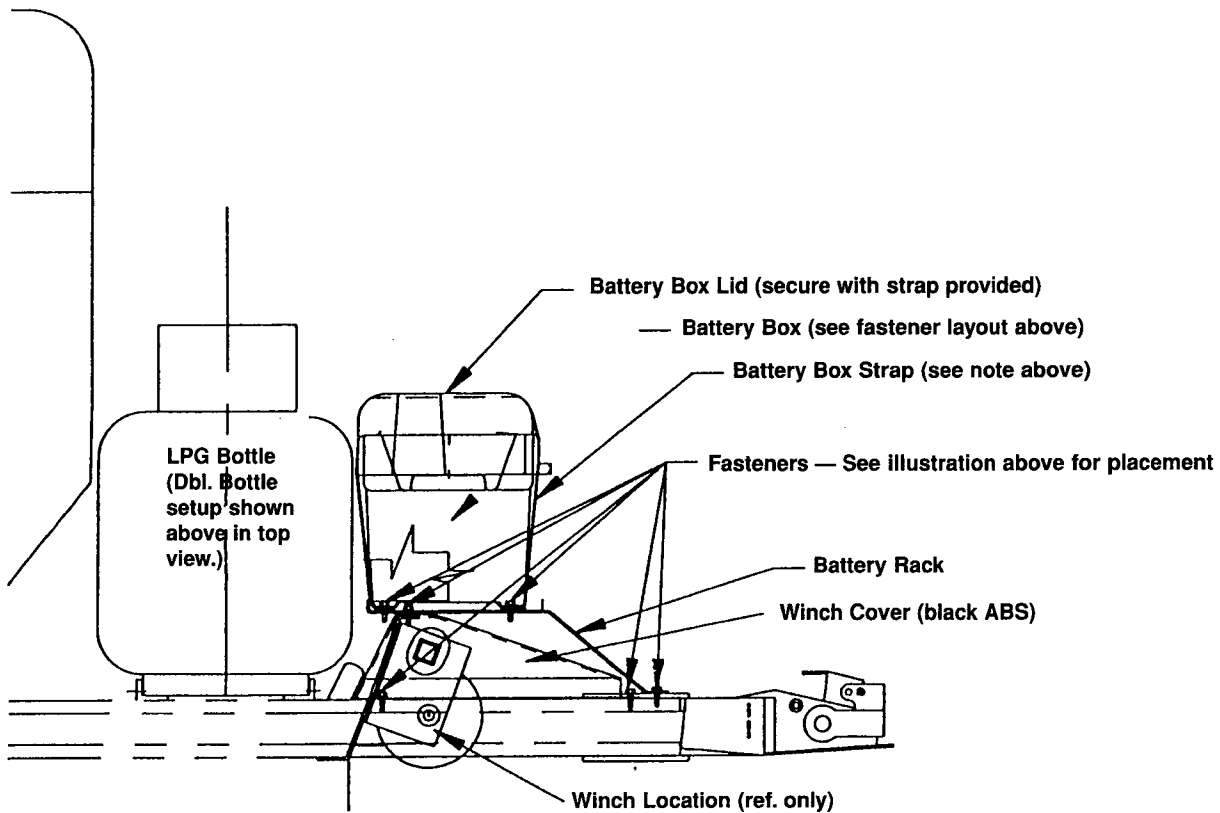
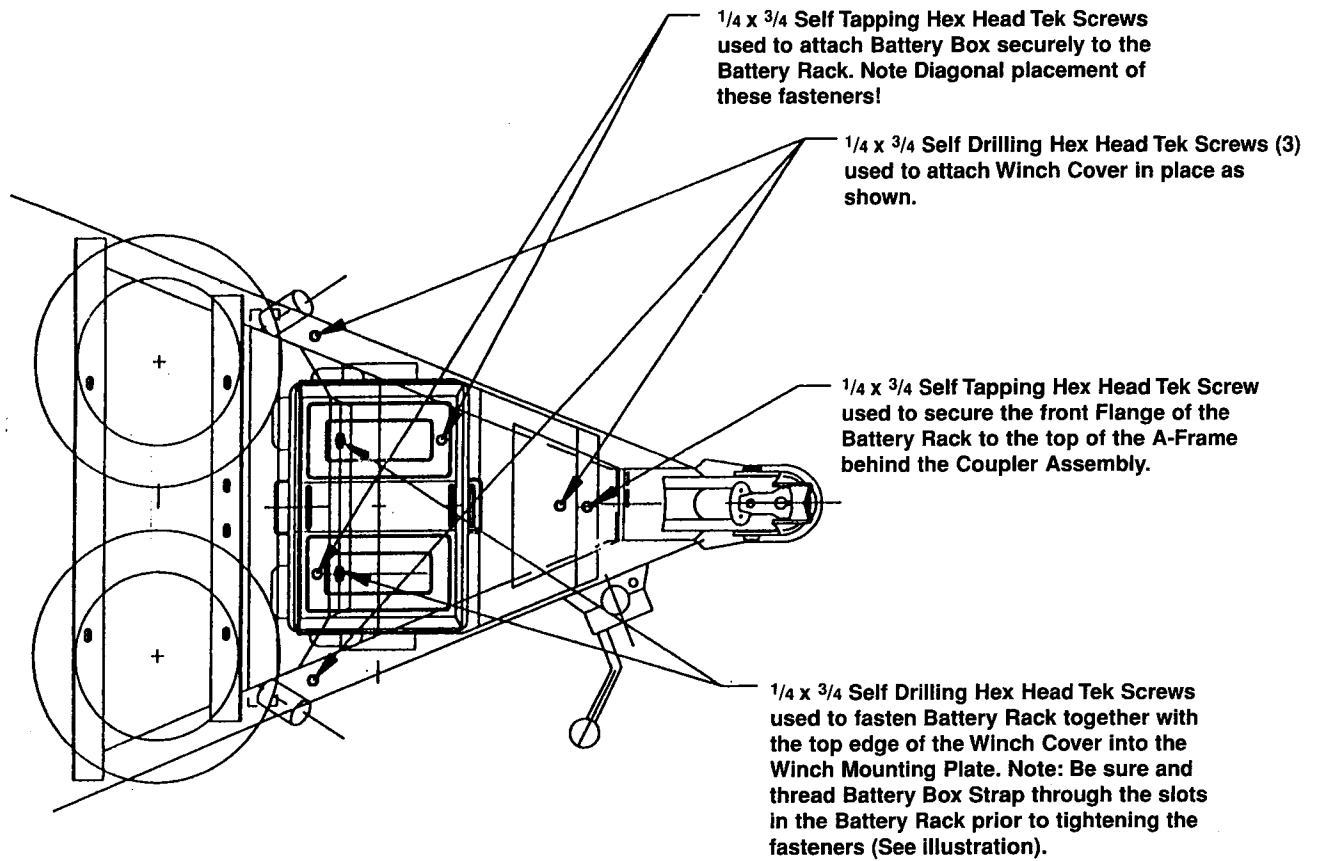

RACK INSTALLATION SHEET



LPG HOSE ROUTING

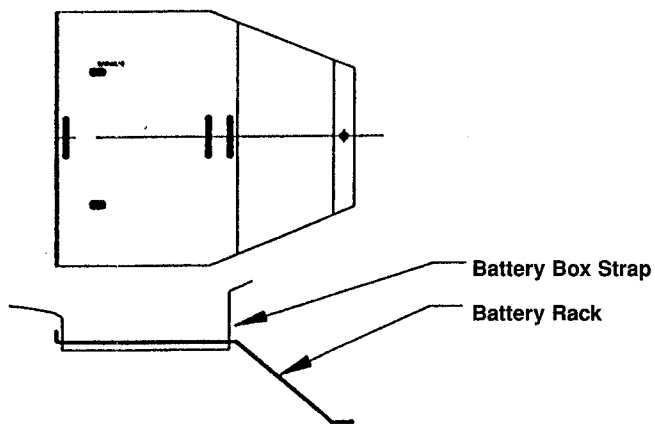

Battery Box Strap Routing Diagram

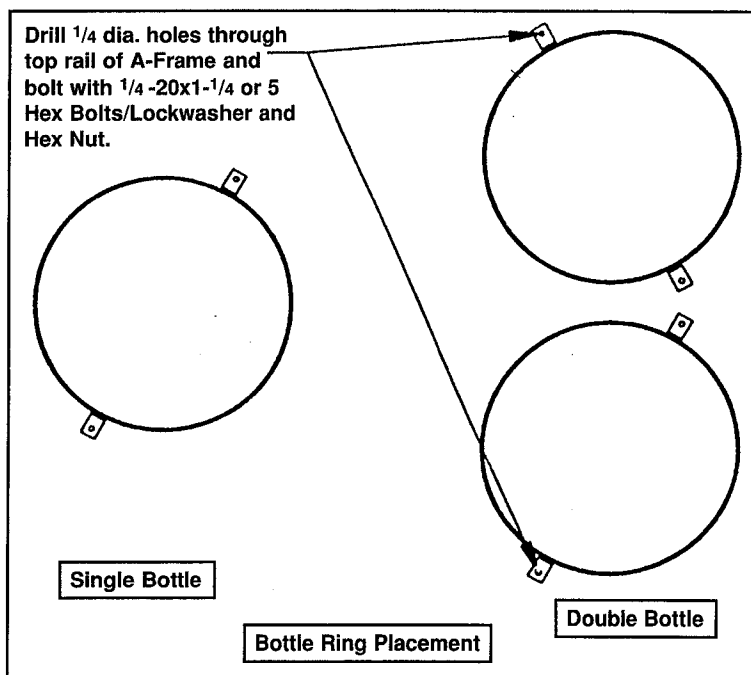

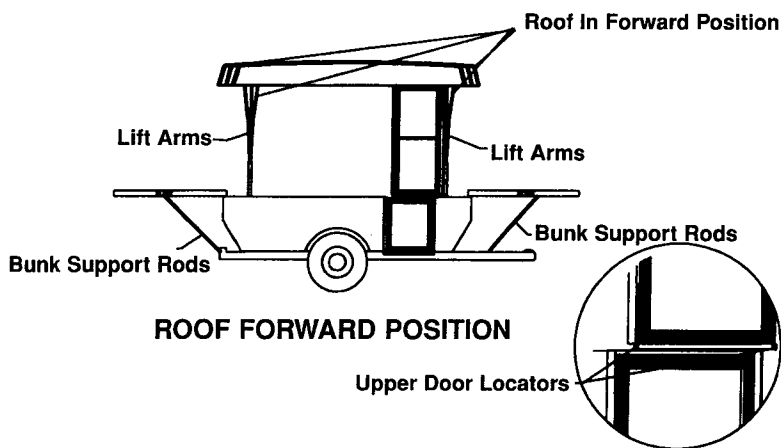

UPPER ENTRANCE DOOR ALIGNMENT PROCEDURE:

During the manufacturing of your Viking Camping Trailer, effort is directed towards providing you with a unit which will allow you ease of setup and operation. The setup at your campsite is very important and can easily be accomplished by following the instructions provided in your Owner's Manual. In this bulletin we are going to emphasize the importance of properly setting the upper entrance door.

- 1-Select a site where you can easily level your unit. (See page 10.)
- 2-When the unit is level, unlatch all four corner roof latches and crank up the roof, using the hand crank provided in the unit or the optional electric system if so equipped.
- 3-With the roof raised to the limit indicated by the green cable located on the door side front corner, lower the leveling jacks, if installed, or position portable jack stands under the front crossmember if you have enough stands available.
- 4-Pull out bunks on each end and install bunk support rods under each bunk as shown on page 11. (Note) These are normally stored under the bunk mattresses on each end or in bumper box.
- 5- At this point you have now stabilized your unit and are ready to proceed with installing the upper entrance door.
- 6- Go inside the unit, flip up the galley assembly and clear the floor of any camping gear, etc. which you may have stored there for travel. **DO NOT INSTALL THE TENSION RAFTERS IN THE BUNK AREAS AT THIS TIME — THIS WILL BE DONE AS DESCRIBED LATER IN THIS BULLETIN!**
- 7- Now to positioning the upper door panel. Unlatch the two turnbuckles located on the end of the upper door, on the ceiling. Be sure to firmly hold the door in place when releasing the turnbuckles. Lower the upper door down into a vertical position, hanging just inside of the tent and lower door area. If the free floating roof is in the proper position, the upper and lower doors will align with each other. **REVIEW THE ILLUSTRATIONS ON THIS BULLETIN FOR DIRECTIONS ON POSITIONING ROOF AND UPPER DOOR ASSEMBLY.** If the door is mis-aligned to the front of the unit (roof forward position) move the roof assembly back until the upper and lower doors align with each other. If the door is mis-aligned to the back of the unit (roof rearward position) move the roof assembly towards the

front of the unit until the upper and lower sections of the door align with each other. MOVEMENT OF THE ROOF ASSEMBLY CAN BE INITIATED BY SIMPLY PUSHING THE UPPER DOOR EITHER TOWARDS THE FRONT OR THE REAR OF THE UNIT.

- 8-Now that you have the two door sections aligned with each other, review Section "A" (Pg. 50). Reach up to the top of the upper door and pull the top of the door towards you while holding the bottom of this assembly over the top of the lower door. You will notice that as you move the top of the assembly inward that the bottom of the upper door will rise up and can be easily moved over the top of the bottom section. When you have positioned the bottom of the upper door over the top of the bottom door you will notice the two (2) upper door locators located on each side of the door. These locators will plug into the openings in the lower door frame and the door will move into a vertical position with the upper door hinge positioned flat against the inside of the roof sideboards. With the hinge now against the inside of the sideboards, secure in place by turning the two turnbuckles which are protruding through the two slots in the hinge.
- 9-With the hinge locked securely in place, simply pull the flaps of the tent around the door frame and push the Velcro strips onto the mating strips on the inside and outside of the upper door frame.
- 10- NOW IS THE TIME TO INSTALL THE BUNK TENSION RAFTERS! These rafters are normally stored under the mattresses at the inside end of the bunks. Simply insert the end of the tension rafter into short section of tubing coming off of the bunk bow, raise the bow and push into position and secure the hook end of the rafter over one of the hooks located on the ceiling of the unit. Repeat on the opposite end.
- 11-After the rafters are installed in their proper position, zip up the tent at each lift arm, install a lift arm metal cover at the door side front and at the off-door side rear and reposition the lift arm tent flaps over the lift arms.
- 12-The roof arms require tolerance to properly function and will allow the roof and door to move 3 inches in all directions. In addition, the attachment of the awning to one side of the roof can pull on the roof and door.
 - It is very important to adjust the stabilizer jacks first. the roof will seek its position based on how you set the jacks, gravity and the leverage force of the awning. To adjust the roof side to side from a level position, raise the off door side jacks enough to eliminate all pressure and contact with ground. Then crank down the door side jacks with firm pressure and return to the other side and crank down jacks with light pressure to ground.
 - Then adjust the tension, height and position of the side awning supports to balance the roof position.
 - Now, if necessary, the upper and lower doorframe and hinge may need occasional adjustment to properly function. Your dealer can demonstrate these simple techniques using the winch handle to adjust the door.

ENTRANCE DOOR SETUP INSTRUCTIONS

(Note: Tent Sections not shown)

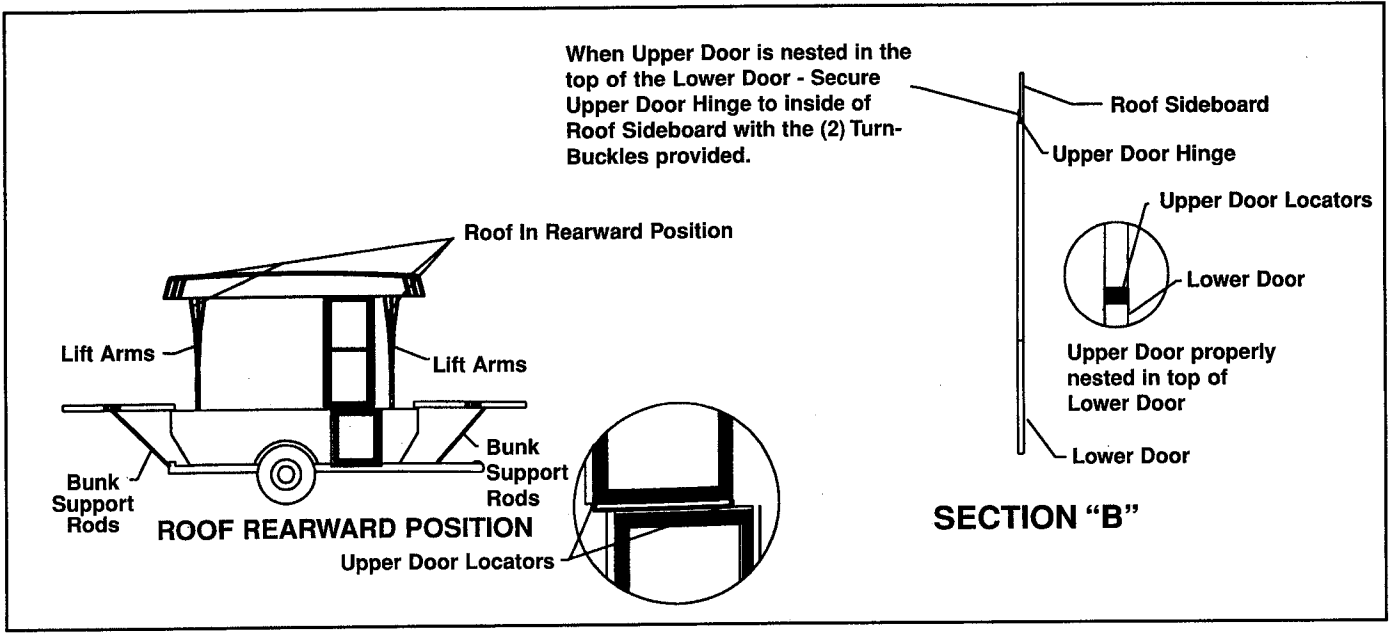
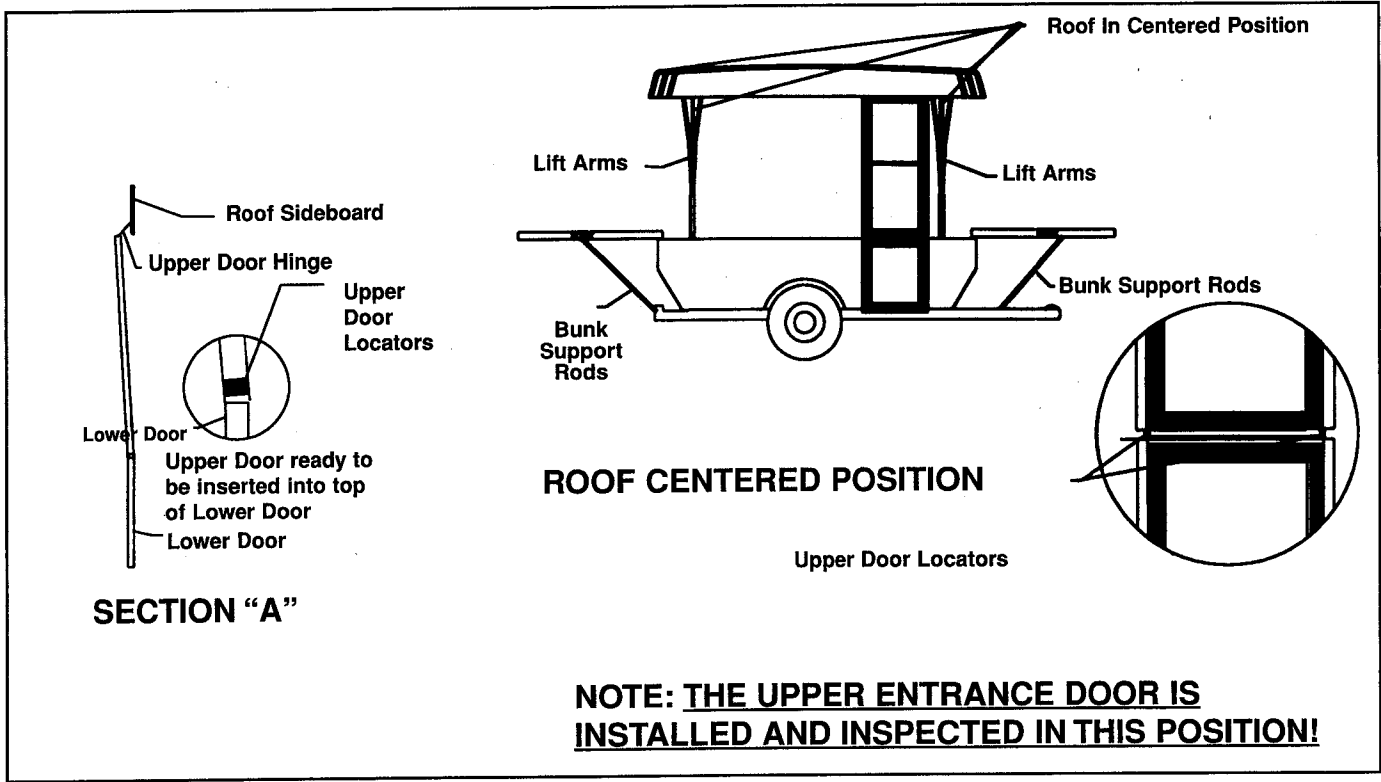

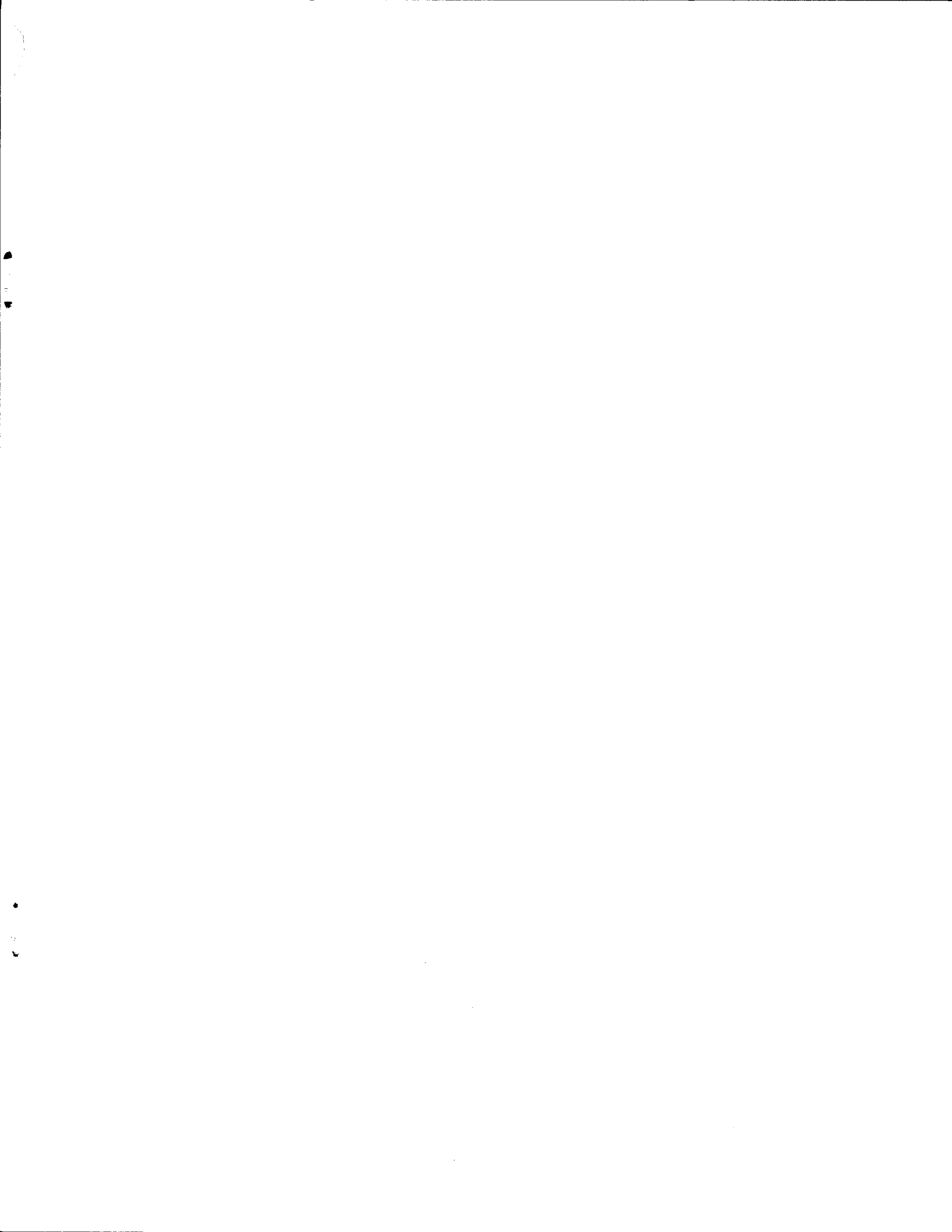

Viking Recreational Vehicles, L.L.C.
580 W. Burr Oak St.
P.O. Box 549
Centreville, MI 49032